



Electrolux

SERVICE MANUAL

Home Comfort

AIR CONDITIONING WITH ELECTRONIC
CONTROL SYSTEM

Split Type Air Conditioner

ZS18V59CCHI
ZS18V59CCHO

ZS18V59CCCI
ZS18V59CCCO

ZANUSSI

Document Revisions

| Rev. | Date | Description | Author |
|------|---------|-------------------|-------------------|
| 00 | 02/2019 | Document creation | Ebraheem Ahmed |

EN

Publication number
599 82 80 - 32
Edition: 02/2019 - Rev. 00

FOR INTERNAL AND PARTNERS USE ONLY

© ELECTROLUX HOME PRODUCTS
Consumer Service - EMEA
Quality & Continuous Improvement - Technical Support

CONTENTS

| | |
|---|----|
| 1. PRODUCT SUMMARY | 4 |
| 2. TECHNICAL SPECIFICATIONS | 5 |
| 3. CONSTRUCTION VIEWS | 6 |
| 3.1 INDOOR VIEW | 6 |
| 3.2 OUTDOOR VIEW | 7 |
| 4. SCHEMATIC DIAGRAMS | 7 |
| 4.1 INDOOR UNIT 12K HP (ZS12V59CCHI) | 7 |
| 4.5 INDOOR UNIT 12K CO (ZS12V59CCCI) | 8 |
| 4.6 OUTDOOR UNIT 12K HP (ZS12V59CCHO) | 8 |
| 4.7 OUTDOOR UNIT 12K CO (ZS12V59CCCO) | 9 |
| 4.11 PRINTED CIRCUIT BOARD | 10 |
| 5. REFRIGERANT SYSTEM DIAGRAM | 11 |
| 5.1 COOLING AND HEATING MODELS | 11 |
| 5.2 COOLING ONLY MODELS | 11 |
| 6. AC OPERATING FUNCTIONS | 12 |
| 7. AC OPERATING FUNCTIONS | 15 |
| 7.1 COOLING OPERATIONS WITH SELECTED FAN SPEED | 15 |
| 7.2 COOLING OPERATIONS WITH AUTO FAN SPEED | 15 |
| 7.3 COOLING OPERATION IN TURBO MODE | 15 |
| 7.4 HEATING OPERATION | 16 |
| 7.5 HEATING OPERATION CONTROL WITH AUTO FAN SPEED | 17 |
| 7.6 HEATING OPERATION IN TURBO MODE | 17 |
| 7.7 DEFROSTING OPERATION | 18 |
| 7.8 AUTOMATIC OPERATION CONTROL | 18 |
| 7.9 COOLING MODE | 19 |
| 7.10 HEATING MODE | 19 |
| 7.11 FREEZING PREVENTION CONTROL | 19 |
| 7.12 DEHUMIDIFYING OPERATION CONTROL | 20 |
| 7.13 SLEEPING OPERATION CONTROL | 21 |
| 7.14 IONIZER OPERATION CONTROL | 22 |
| 7.15 VENTILATING OPERATION CONTROL | 23 |
| 7.16 X-FAN (SELF CLEAN) OPERATIONS | 23 |
| 7.17 ADJUSTING THE AIR FLOW DIRECTION OPERATIONS | 23 |
| 8. PRECAUTIONS | 24 |
| 8.1 ELECTRICAL SAFETY PRECAUTIONS | 24 |
| 8.2 INSTALLATION SAFETY PRECAUTIONS | 24 |
| 8.3 TRANSPORTATION SAFETY PRECAUTIONS | 24 |
| 8.4 PRODUCT DESCRIPTION | 25 |

| | |
|---|----|
| 9. BEFORE INSTALLATION | 26 |
| 9.1 TOOLS NEEDS FOR INSTALLATION | 26 |
| 9.2 ACCESSORIES | 26 |
| 9.3 INSTALLATION DETAILS | 26 |
| 9.4 INSTALLATION SUMMARY | 28 |
| 9.5 OUTDOOR UNIT INSTALLATION | 28 |
| 9.6 PIPING CONNECTION SUMMARY | 29 |
| 9.7 INSTALLATION OF ELECTRICAL WIRES SUMMARY | 30 |
| 10. NEW REFRIGERANT (R410A) | 30 |
| 10.1 TYPICAL APPLICATIONS | 31 |
| 10.2 SAFETY PRECAUTIONS | 31 |
| 10.3 R410A CHARGING INSTRUCTION | 32 |
| 10.4 R410A PRESSURE TEMPERATURE CHART | 33 |
| 10.5 VACUUMING AND REFRIGERANT CHARGING & DISCHARGING PROCESS | 35 |
| 11. CLEANING AND MAINTENANCE | 36 |
| 11.1 BEFORE MAINTENANCE | 36 |
| 11.2 CLEANING THE UNIT | 36 |
| 11.3 CLEANING THE FILTERS | 36 |
| 11.4 CLEANING THE AIR OUTLET AND THE PANEL | 37 |
| 11.5 PREPARATION FOR EXTENDED NON OPERATION | 37 |
| 12. TROUBLESHOOTING | 38 |
| 13. DISASSEMBLY AND REASSEMBLY INSTRUCTIONS | 40 |
| 13.1 INDOOR UNIT | 40 |
| 13.2 OUTDOOR UNIT | 43 |
| 14. EXPLODED VIEW INDOOR UNIT | 47 |
| 15. EXPLODED VIEW OUTDOOR UNIT | 48 |

1. PRODUCT SUMMARY

| INDOOR UNIT | |
|--------------|---------------|
| VESTEL MODEL | ZANUSSI MODEL |
| 18K HP | ZS18V59CCHI |
| 18K CO | ZS18V59CCCI |



| OUTDOOR UNIT | |
|--------------|---------------|
| VESTEL MODEL | ZANUSSI MODEL |
| 18K HP | ZS18V59CCHO |
| 18K CO | ZS18V59CCCO |

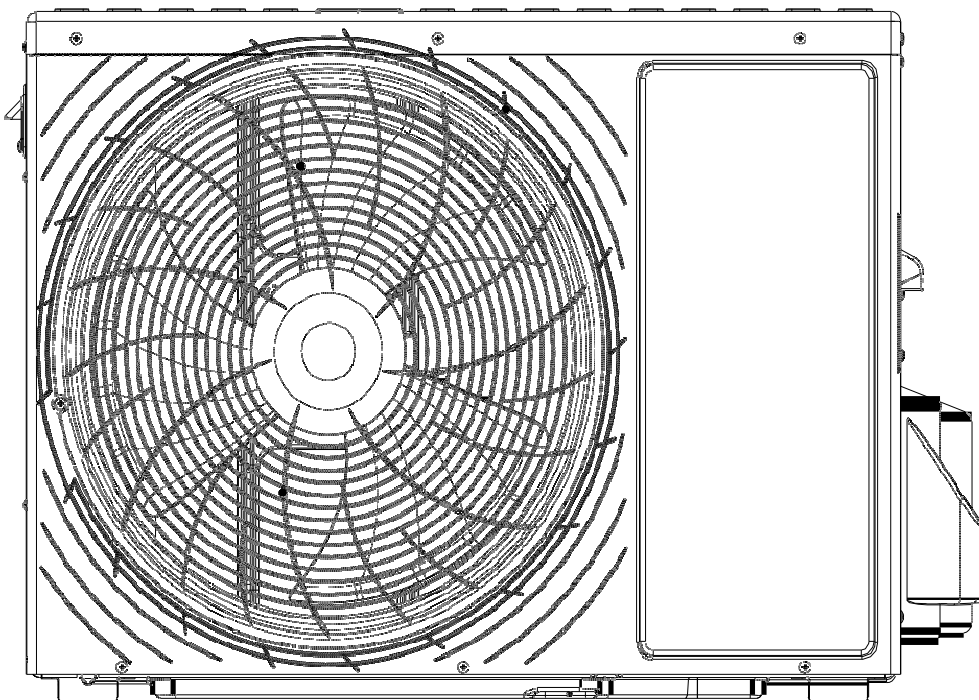

2. TECHNICAL SPECIFICATIONS

| | | | | |
|---------------------------------|-------------------------------------|----------------------|----------------|----------------|
| BRAND | | | ZANUSSI | ZANUSSI (*) |
| Model | (*) Cooling Only | | ZS18V59CCHI | ZS18V59CCCI |
| | | | ZS18V59CCHO | ZS18V59CCCO |
| Controller Type | | | VELK 18 | VELK 18 |
| Nominal Capacity | Cooling | Btu/h | 19.864 | 19.864 |
| Nominal Capacity | Heating | Btu/h | 20.267 | / |
| Nominal Capacity | Cooling | (kW) | 5.821 | 5.821 |
| Nominal Capacity | Heating | (kW) | 5.940 | / |
| Input Power | Cooling | W | 1.862 | 1.862 |
| Input Power | Heating | W | 1.800 | / |
| Operating Current | Cooling | A | 8,38 | 8,43 |
| Operating Current | Heating | A | 8,56 | / |
| EER | Cooling | | 3,12 | 3,12 |
| COP | Heating | | 3,3 | / |
| Seasonal Energy Class | Cooling/Heating | | C | C |
| Fan motor | Indoor | | DC | DC |
| | Outdoor | | AC | AC |
| Refrigerant | Type | | R410A | R410A |
| | gr | | 1300 | 1275 |
| Outdoor Unit Dimensions | WxHxD | mm | 911x619x320 | 911x619x320 |
| Indoor Unit Dimensions | WxHxD | mm | 1053x323x226 | 1053x323x226 |
| Compressor | Model | | RECHI (50A473) | RECHI (50A473) |
| | Type | | Rotary | Rotary |
| | Motor Type | | PSC | PSC |
| | Oil Type | | POE | POE |
| | Oil Amount | ml | 510 | 510 |
| Max. Piping Distance | Height (IDU - ODU Level Difference) | m | 10 | 7 |
| | Length | m | 20 | 20 |
| Additional Gas Amount | | g/m | 20 | 20 |
| Main Supply Cable | Indoor Unit | No x mm ² | 3x2.5 | 3x2.5 |
| Power and Interconnection Cable | | No x mm ² | 5x1 | 5x1 |
| Piping Diameter | Discharge | Inch | 1/4 | 1/4 |
| | Suction | Inch | 1/2 | 1/2 |

| Operation Data | | | | | | | |
|----------------------------|---------|------------|-------------------|--------------------------|-------------|-----------------|------------------|
| Temperature condition (°C) | | Model name | Standard Pressure | Heat exchanger pipe temp | | Indoor fan mode | Outdoor fan mode |
| Indoor | Outdoor | | P (Mpa) | T1 (°C) | T2 (°C) | | |
| 27/19 | 35/24 | 18K | 0,826 | 9,36~7,08 | 39,16~82,68 | High | High |
| 32/23 | 43/26 | 18K | 0,938 | 12,14~10,65 | 46,35~98,51 | High | High |
| Temperature condition (°C) | | Model name | Standard Pressure | Heat exchanger pipe temp | | Indoor fan mode | Outdoor fan mode |
| Indoor | Outdoor | | P (Mpa) | T1 (°C) | T2 (°C) | | |
| 20/15 | 7/6 | 18K | 3,02 | 36,16~76,71 | 0,14~1,41 | High | High |
| 27/18,5 | 24/18 | 18K | 2,983-3,603 | 46,7~79,61 | 14,38~5,8 | High | High |

T1: Outlet and inlet pipe temperature of evaporator
T2: Outlet and inlet pipe temperature of condenser
P : Pressure of air pipe used for connecting outdoor and indoor units

3. CONSTRUCTION VIEWS

3.1 Indoor View

| INDOOR UNIT | |
|--------------|---------------|
| VESTEL MODEL | ZANUSSI MODEL |
| 18K HP | ZS18V59CCHI |
| 18K CO | ZS18V59CCCI |

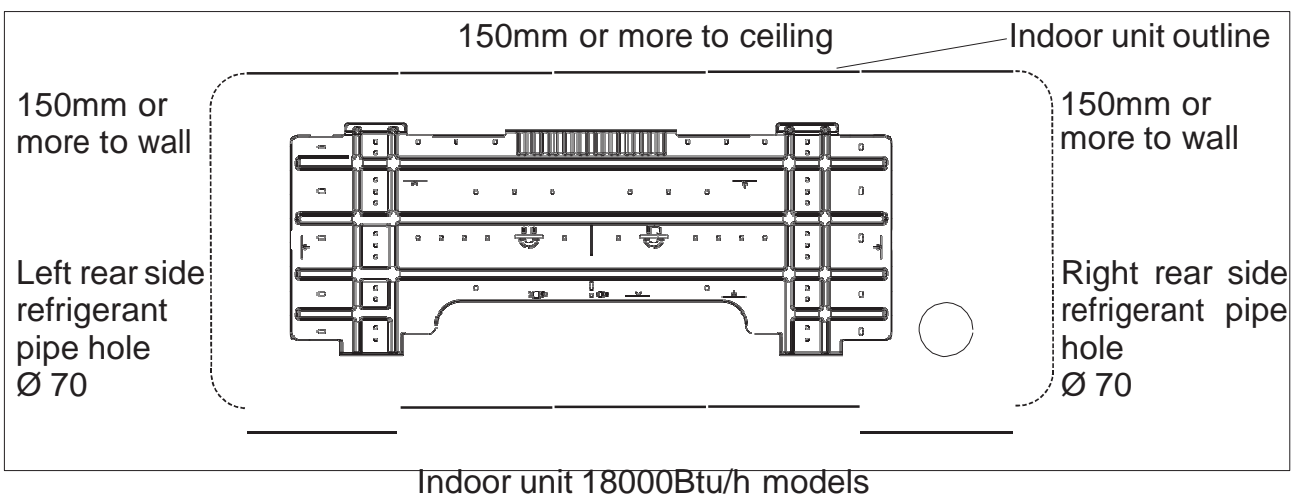
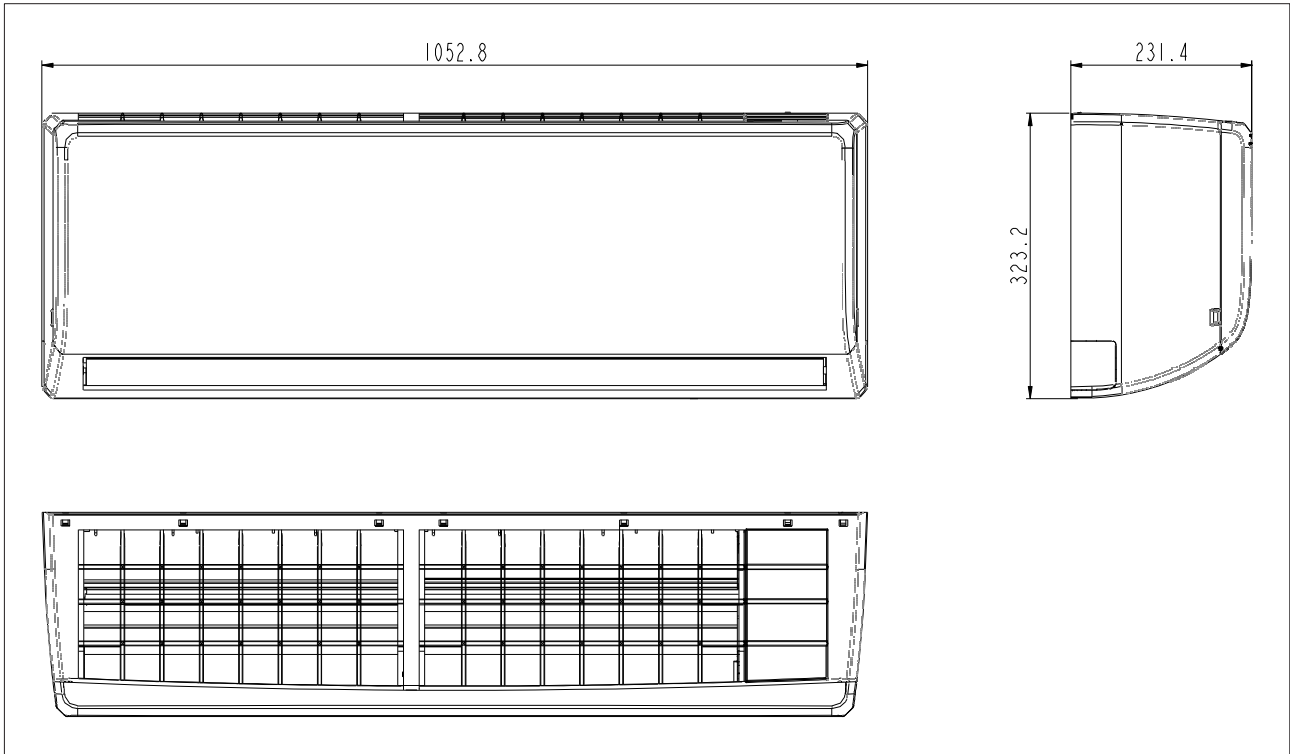

3.2 Outdoor View

| OUTDOOR UNIT | |
|--------------|---------------|
| VESTEL MODEL | ZANUSSI MODEL |
| 18K HP | ZS18V59CCHO |
| 18K CO | ZS18V59CCCO |

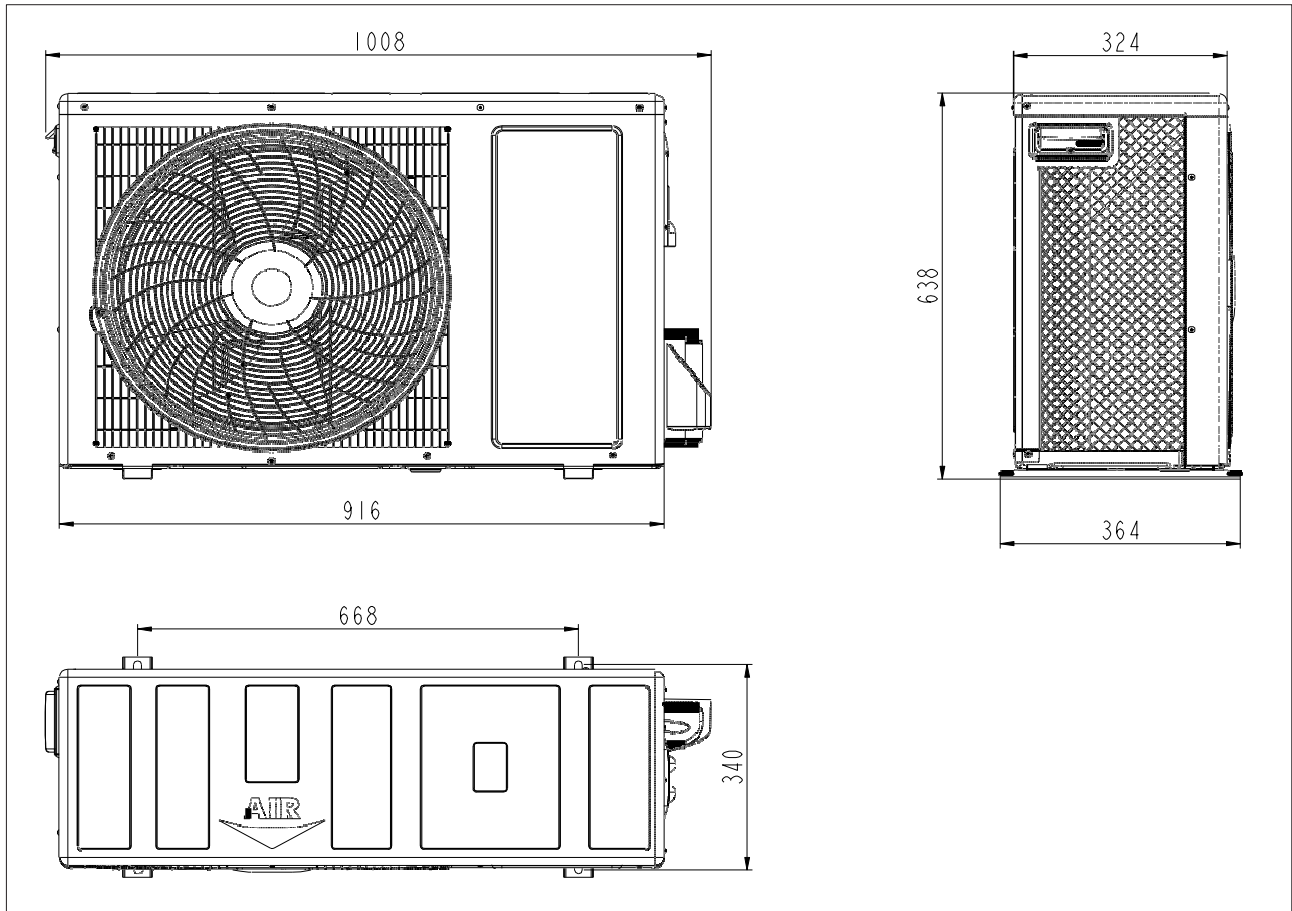

3.3 Indoor Unit 18K HP ()

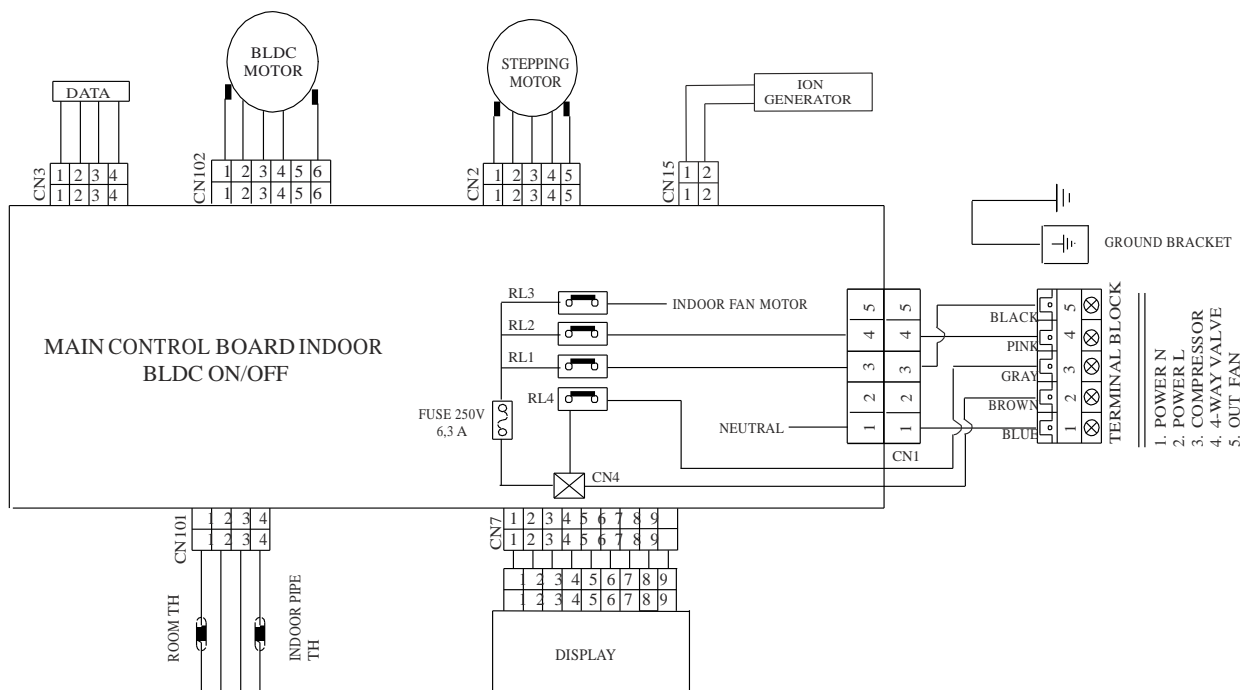

3.4 Indoor Unit 18K CO ()

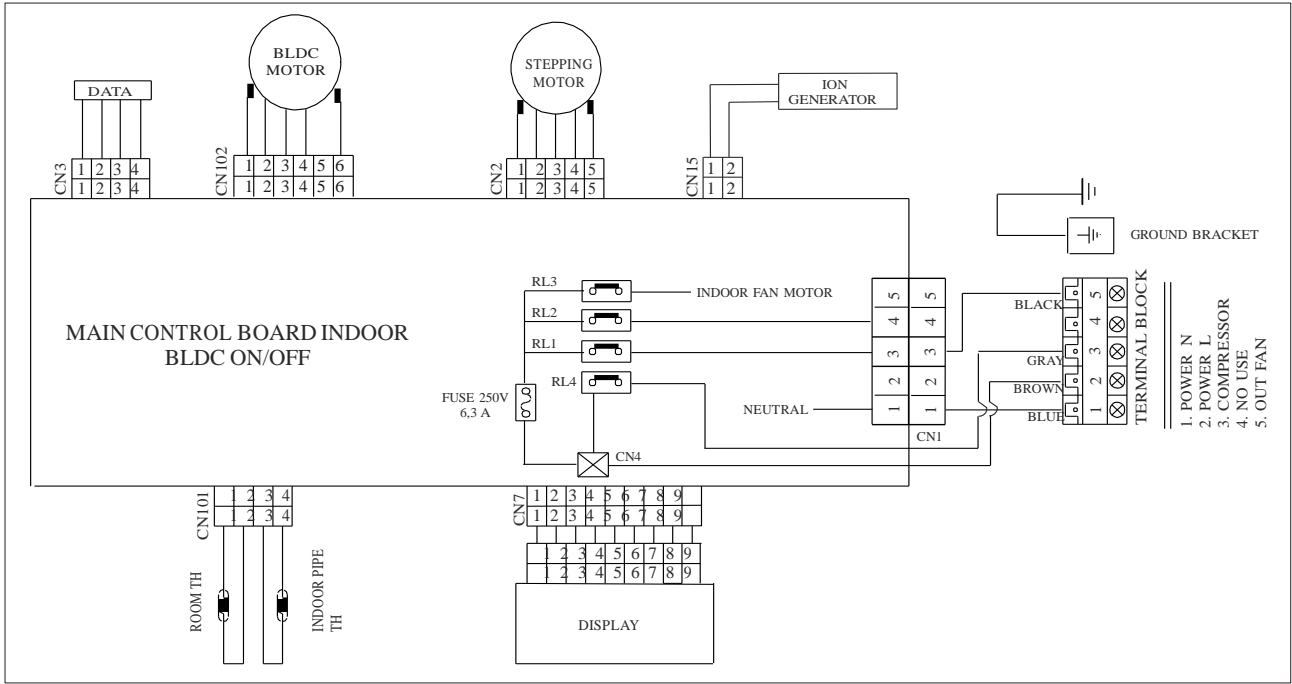

3.5 Outdoor Unit 18K HP ()

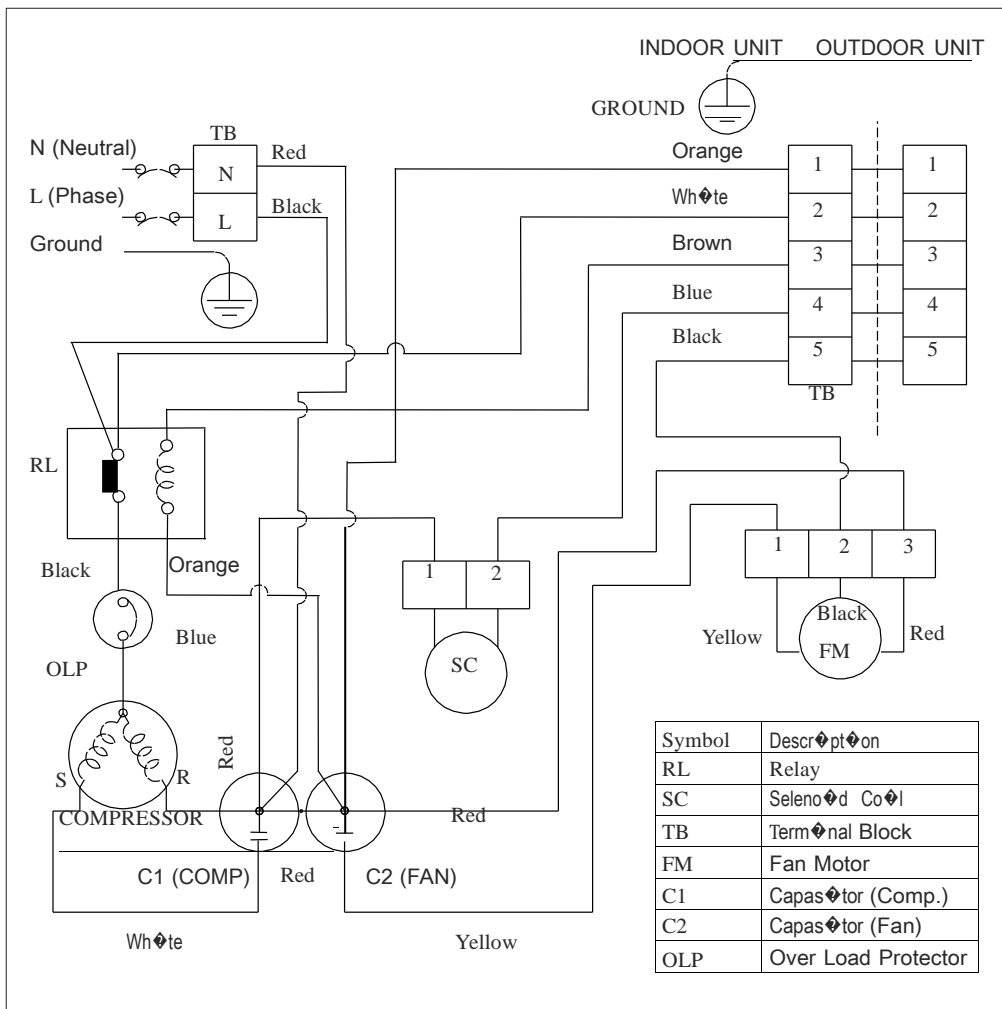

3.6 Outdoor Unit 18K CO ()

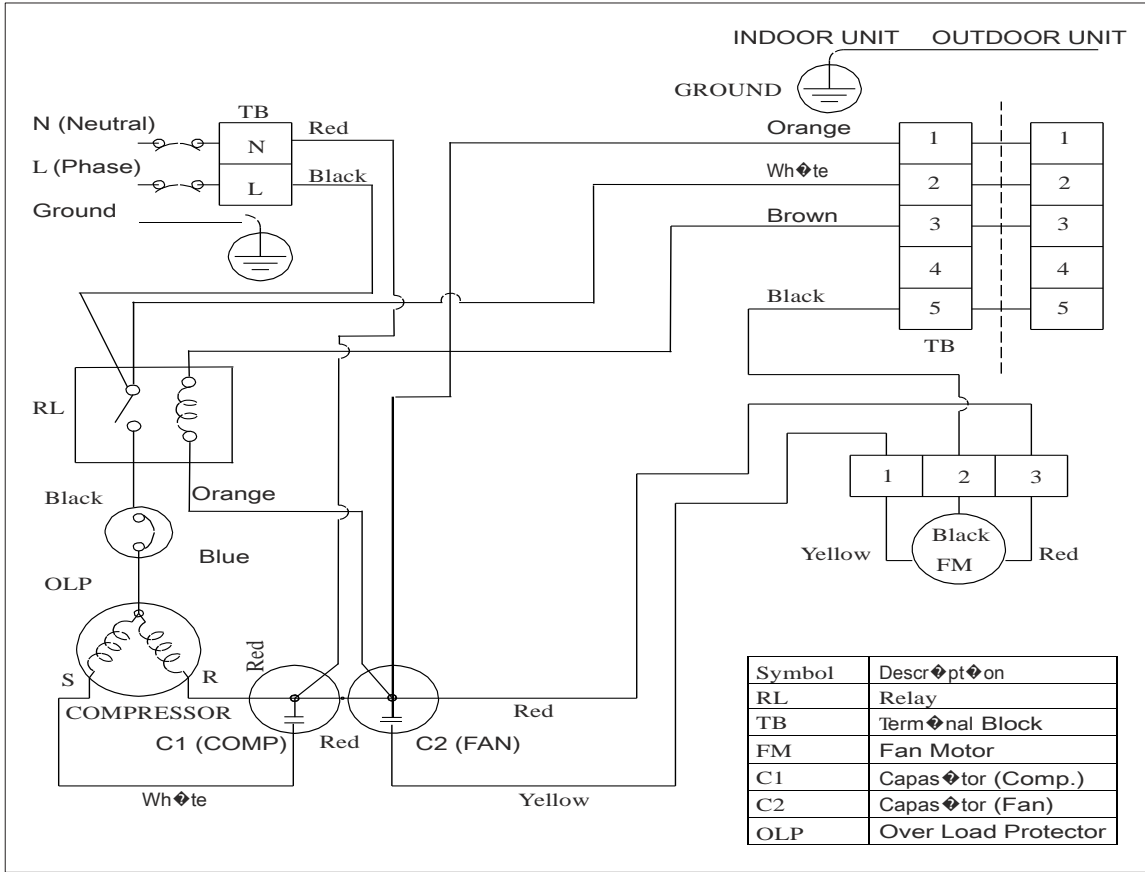

3.7 PRINTED CIRCUIT BOARD

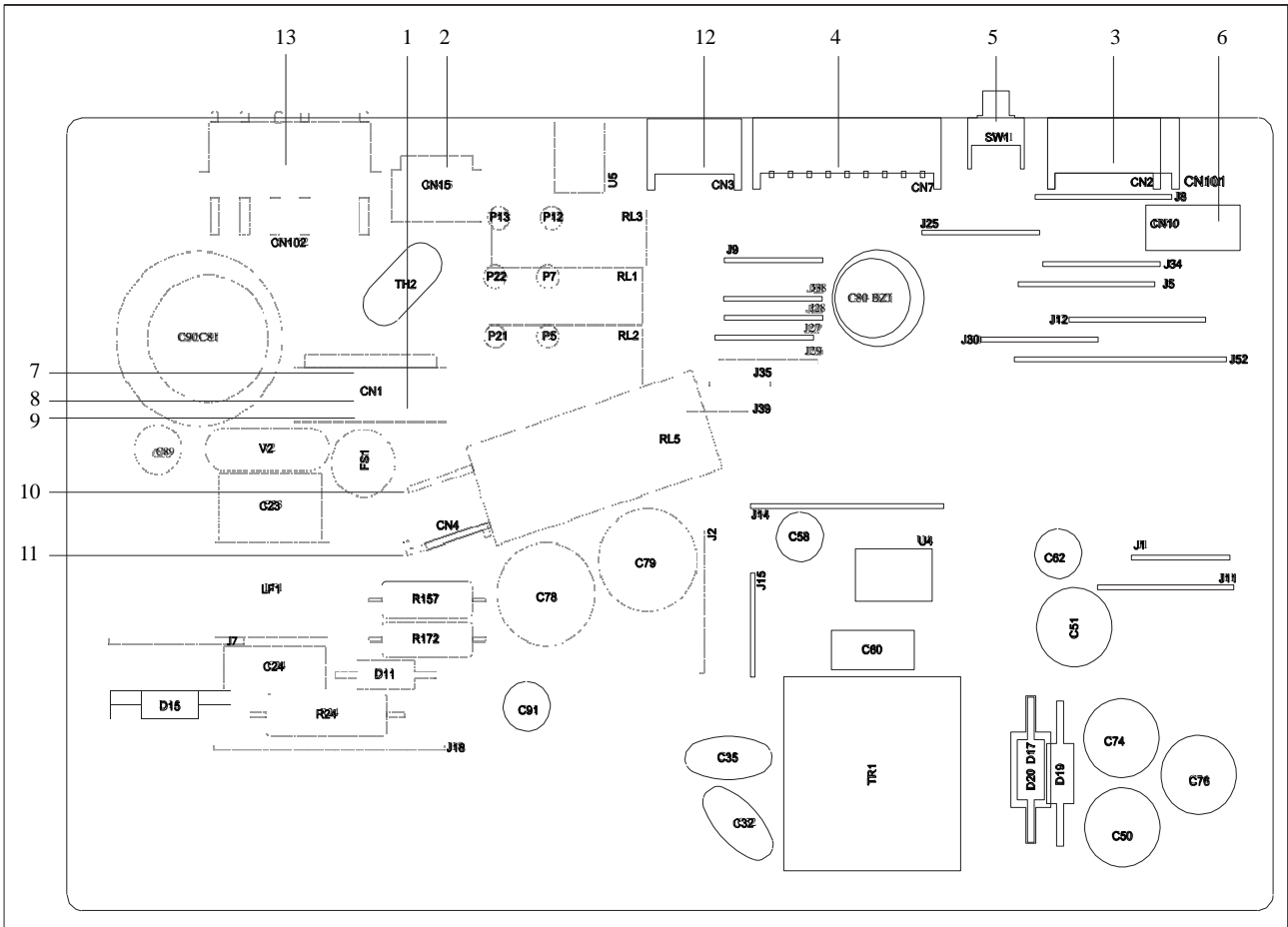

| | |
|----|--|
| 1 | Interface of outdoor fan motor |
| 2 | Ionizer |
| 3 | Up & down swing |
| 4 | Display interface |
| 5 | Auto button |
| 6 | Interface of ambient & pipe temperature sensor |
| 7 | Interface of live wire |
| 8 | Interface of out fan |
| 9 | Interface of 4-way valve |
| 10 | Interface of compressor |
| 11 | Interface of health function live wire |
| 12 | Interface of data |
| 13 | Interface of data |

4. REFRIGERANT SYSTEM DIAGRAM

4.1 Cooling And Heating Models

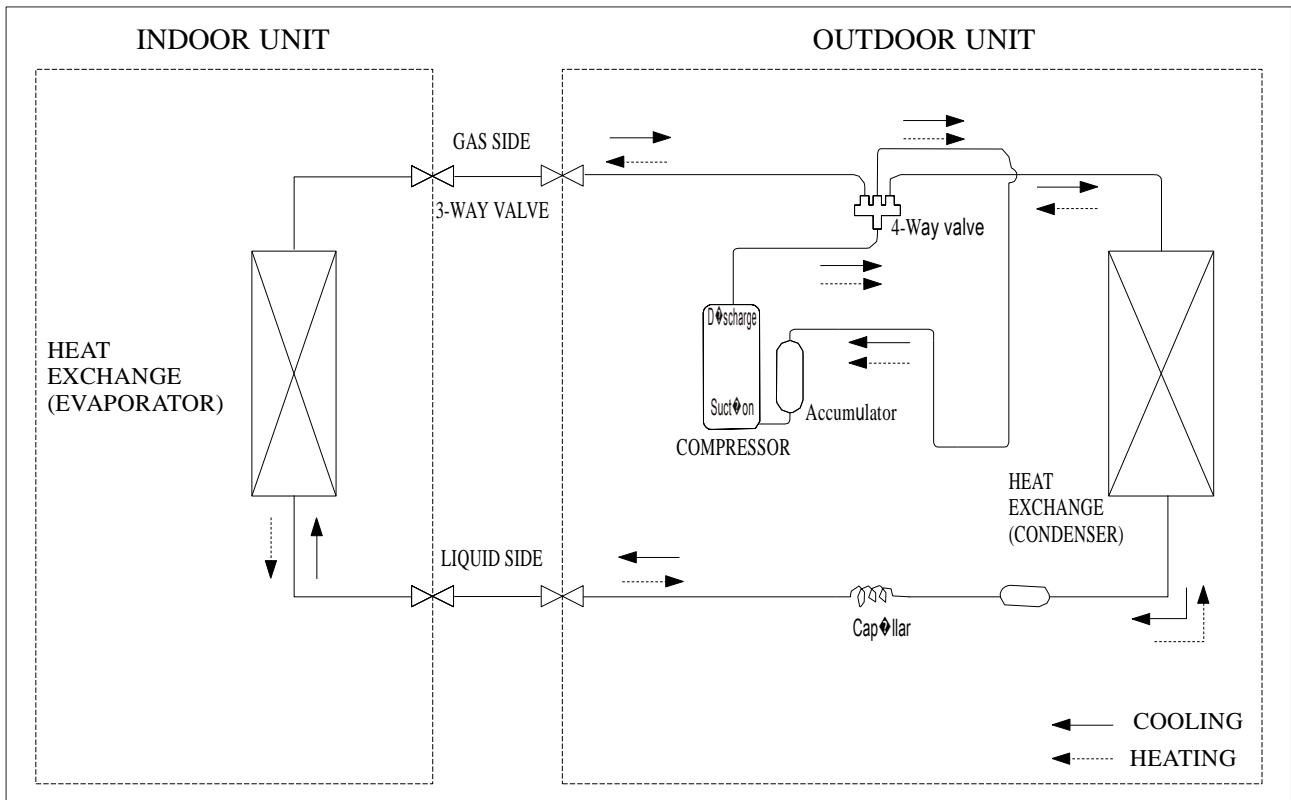

4.2 Cooling Only Models

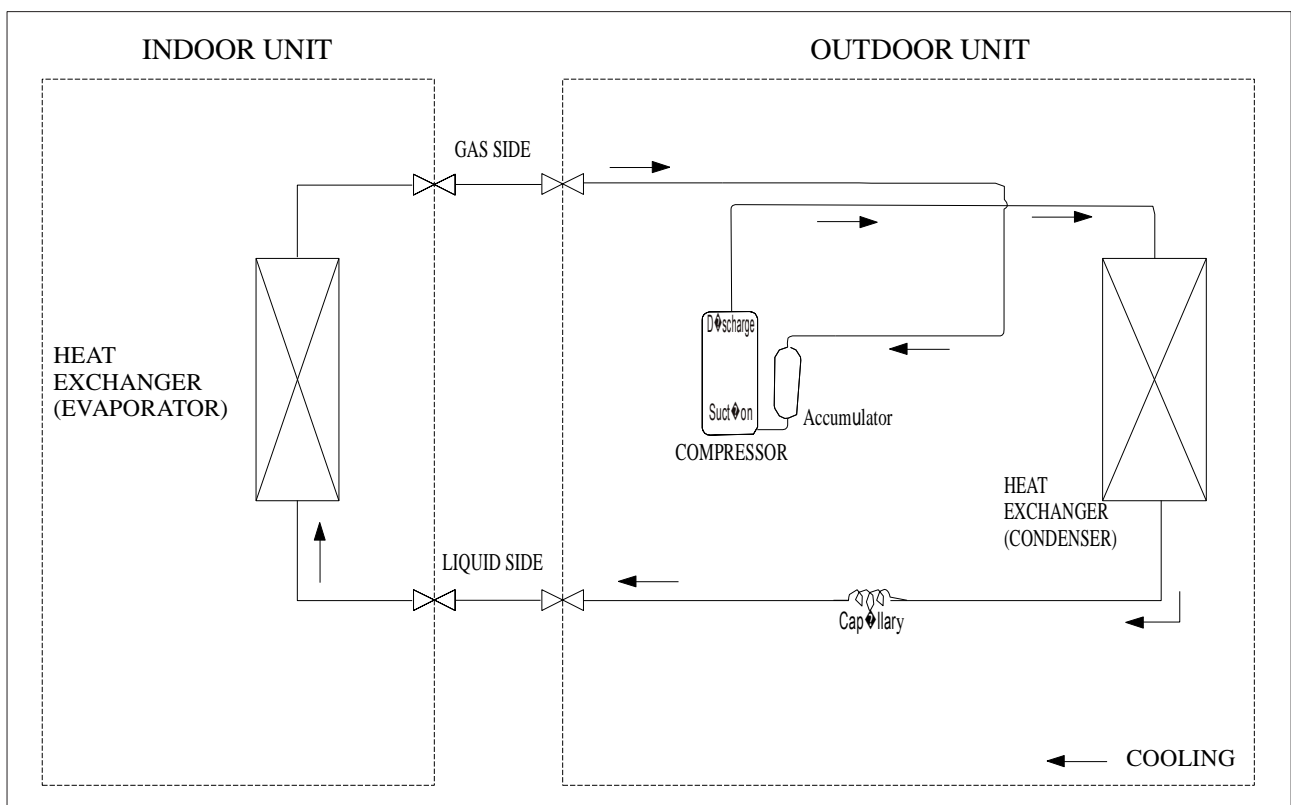

Refrigerant pipe diameters for all 18K models;

Liquid: 1/4" (6mm)





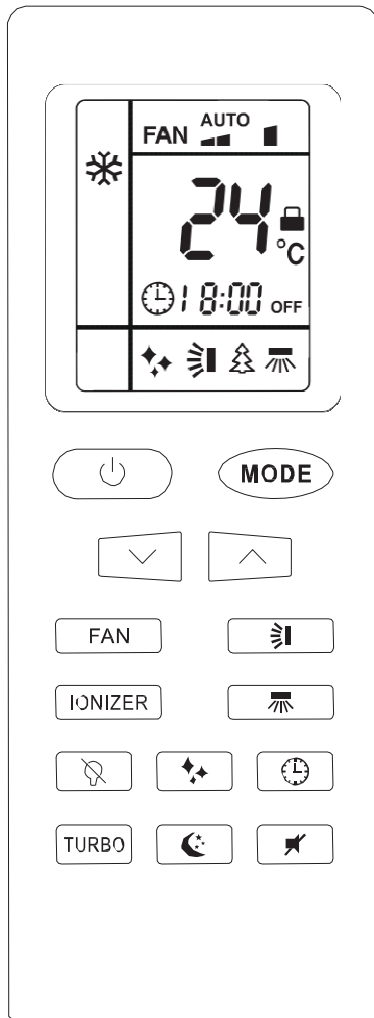

Gas: 1/2" (12mm)

5. AC OPERATING FUNCTIONS

 Ensure the unit is plugged in and power is available.

Automatic Operation



1. Press the ON/OFF button () to turn on the air conditioner.
2. Press the MODE button (**MODE**) until you see the  symbol on the remote control display to select Auto. Your air conditioner will determine its operating mode automatically according to the environment temperature.
3. Press the UP/DOWN button (/) to set the desired temperature. The temperature can be set within a range of 22° C~26 °C. Default temperature is 24 °C.
4. Depending on the environment temperature, it performs cooling or heating. In this mode, the air conditioner operates with the target of 24 +/- 2 °C adjustment interval.
 - In this mode, you may increase or decrease the target temperature value for cooling or heating up to 2 °C. You can use  and  to change the temperature value.
 - In the Auto mode, the fan speed can not adjustable.
 - If the Auto mode is not comfortable for you, the desired mode can be selected manually.
5. With **MODE** button, you can switch between automatic mode, cooling, heating, fan, and dry in a fast way. By each press the **MODE** your air conditioner will switch to the next mode.







6. The air conditioner operates at cooling mode if the environment temperature is higher than setting temperature or operates at heating mode if the environment temperature is lower than setting temperature.

 When you turn the air conditioner on with the on/off button on the indoor unit, the air conditioner starts to operate in automatic mode.





The Turbo function can be adjusted in Auto mode.

The Ionizer can be activated in Auto mode.



Cooling Function

1. Press the ON/OFF button () to turn on the air conditioner.
2. Your air conditioner will start running in the mode you selected last.
3. Press **MODE** until  symbol on the display of your remote is appeared.
4. After selecting the cooling mode, with  and  buttons, you may adjust the desired temperature between 20–28° C according to your comfort need.
5. Every time you press the buttons, temperature with 1 °C interval. The lowest temperature in cooling mode is 20°C.
6. In cooling mode, you can adjust the fan speed with **FAN** button, and direction of vertical air flow with  button.
7. You may change the mode at any time you want.

Heating Function

1. Press the ON/OFF button () to turn on the air conditioner.
2. Your air conditioner will start running in the mode you selected last.
3. Press **MODE** until  symbol on the display of your remote is appeared.
4. After selecting the heating mode, with  and  buttons, you may adjust the desired temperature between 20–28° C according to your comfort need.
5. Every time you press the buttons, temperature with 1 °C interval. The highest temperature in heating mode is 28 °C.
6. In heating mode, you can adjust the fan speed with **FAN** button, and direction of vertical air flow with  button.
7. You may change the mode at any time you want.







Fan Function

1. Press the ON/OFF button (⏻) to turn on the air conditioner.
2. Press  button until you see **MODE** symbol on display of your remote is appeared.
3. You may choose the desired fan speed by pressing  button.
4. You may also change the horizontal louver position in this mode.
5. Compressor does not operate when the fan function is active, .

Indoor Unit Fan Speed Adjustment

You may adjust the air flow speed by pressing the fan button on the remote control. There are 5 different speed levels for the fan speed.

Adjustable speed levels:

| | |
|---|-----------------|
|  | Automatic Speed |
|  | Very low |
|  | Low |
|  | Medium |
|  | Medium-High |
|  | High |





In the fan mode, the automatic fan speed cannot be chosen.

Ionizer Function

- You can enable the Ionizer function with IONIZER. Researches show that the air with more anion make us feel more lively and energetic. Ionizer produces anions and diffuse them to the environment air for this purpose. To disable the function, press IONIZER again.
 - The negative ion emission may cause dust like particles to accumulate on the indoor unit of your air conditioner. Hence, make sure to clean your air conditioner periodically (once a week) with a wet and soapy wipe.
 - During the cleaning operation, certainly cut the power from the power supply.
-

Horizontal Swing Function

1. Press ON/OFF button (⏻) to turn on the air conditioner.
2. You can adjust direction of the air flow vertically by pressing  button.
3. Every time you press the button, the position of the louver changes.
4. The horizontal louver can be adjusted in 5 different positions.
5. If you keep to press the  button, horizontal louver start to move up and down automatically. If you press the button one more time, the movement will stop.



Never try to adjust the horizontal louver by hand.

X-Fan (Self Clean)

 button allows your air conditioner to clean up the indoor heat exchanger by drying the water accumulated on it due to condensation when the air conditioner is operating in cooling and dehumidification modes. This function starts when you turn off your air conditioner and the fan operates for 2 minutes.

- SC letters will be blinked on the indoor unit's display for 3 seconds when the function is enabled than setting temperature will be appeared again.
- SC letters will be appeared for 2 minutes during the self cleaning operation after you down the air conditioner.

This function can not be enabled in heating and fan modes.

When the function is active, do not try to close the horizontal louver on the air outlet, it will be closed automatically after the self cleaning operation ends.

Display Light Button

You can turn off the light of the indoor unit with  button if it makes you uncomfortable.







Display light will be turned on when you turn on the air conditioner again.

Timer On/Off Function

1. You can adjust the time interval when you want to turn on or off the air conditioner later.
 2. You can adjust only turn on or turn off time at once.
 3. The time interval can be adjusted between 30 minutes and 24 hours by 30 minutes increments.
-



Timer on settings:

1. To set the auto on time, press  when the air conditioner and remote control are off.  will appear on the display of the remote control.
2. Each time you press , the time will start from 00:30 to 24:00 with 30 minutes increments. If you press and hold , the values will increase swiftly and when you reach 24:00, it will return to 00:30.
3. Release the button when the desired time appears on the display of the remote control. The settings will be saved in 3 seconds. The set time will appear on the display of the remote control as follows.







- The remaining time for auto-on will appear as a countdown on the display of the remote control when the countdown for the set time starts



- You can press  once again to change the turn-on time.
- You can press  for 3 seconds to cancel the timer on function.



Timer off settings:

1. To set the auto off time, press  when the air conditioner and remote control are on.  will appear on the display of the remote control.
2. Each time you press , the time will start from 00:30 to 24:00 with 30 minutes increments. If you press and hold , the values will increase swiftly and when you reach 24:00, it will return to 00:30.
3. Release the button when the desired time appears on the display of the remote control. The settings will be saved in 3 seconds. The set time will appear on the display of the remote control as follows.



- The remaining time for auto-off will appear as a countdown on the display of the remote control when the countdown for the set time starts.





- You can press  once again to change the turn-off time.
 - You can press  for 3 seconds to cancel the timer off function.
-





Turbo Function

1. Press ON/OFF button () to turn on the air conditioner.
 2. You can use turbo function with TURBO in order to cool or heat your room in the shortest time as possible. Your air conditioner will switch to the last settings in selected after 30 minutes.
 3. In order to stop the turbo function before the time is run out, press TURBO again.
-



Signal (Beep) Sound Cancellation Function

You can mute the beep sound that the signal received by the air conditioner with  button. If you want to hear the beep sound press  button again.

Child Lock Function

You can prevent your children to use the air conditioner without your permission by this function. To enable the function, press  and  on the remote control simultaneously for more than 1 second. Release the buttons when  appeared on the display of the remote control. When the symbol is appeared, all buttons will be non-functional. To cancel the lock, press  and  simultaneously again and release the buttons when the lock symbol is disappeared. The lock symbol will disappear and all buttons will be functional again.

Sleep Function

1. Press ON/OFF button () to turn on the air conditioner.
 2. When the sleep function is enabled with , your air conditioner operates with the most appropriate comfort for your sleep. This function prevents the over heating or cooling of the room during sleep.
 - Display of the air conditioner will light off in approximately 3 minutes after the sleep function is selected.
 - You can operate the sleep function and the timer off function together.
 - When sleep function is active, the air conditioner's capacity may decrease.
 - When the sleep function is completed, the air conditioner will turn off completely.
 - When you select sleep function, if your air conditioner currently operates in cooling mode, the setting temperature will be increased 1°C at the end of the first hour and 1°C more the end of the second hour. Sleep function will end after the air conditioner run 6 hours at this temperature.
 - When you select sleep function, if your air conditioner currently operates in heating mode, the setting temperature will be decreased 2°C at the end of the first hour and 2°C more the end of the second hour. Sleep function will end after the air conditioner run 6 hours at this temperature.
-

6. AC OPERATING FUNCTIONS

Description of each control operations

6.1 Cooling Operations With Selected Fan Speed

When Room Temp $\leq T_s$, Thermo OFF condition

COMP OFF, Outdoor fan OFF.

Indoor fan motor selected fan speed

NOTE:

- Outdoor fan stops after 2 seconds than the compressor.
- When the compressor and outdoor fan stop at the beginning of thermo OFF, the indoor fan continues to operate with selected fan speed.

When Room Temp $\geq T_s + 1^\circ\text{C}$, Thermo ON condition

COMP ON, Outdoor fan ON.

Indoor fan motor + selected fan speed

NOTE:

Compressor begins to operate after 2 seconds than the outdoor fan.

⚠ Freezing Prevention control (Low temperature release) has priority over COMP, Outdoor and Indoor fan control.

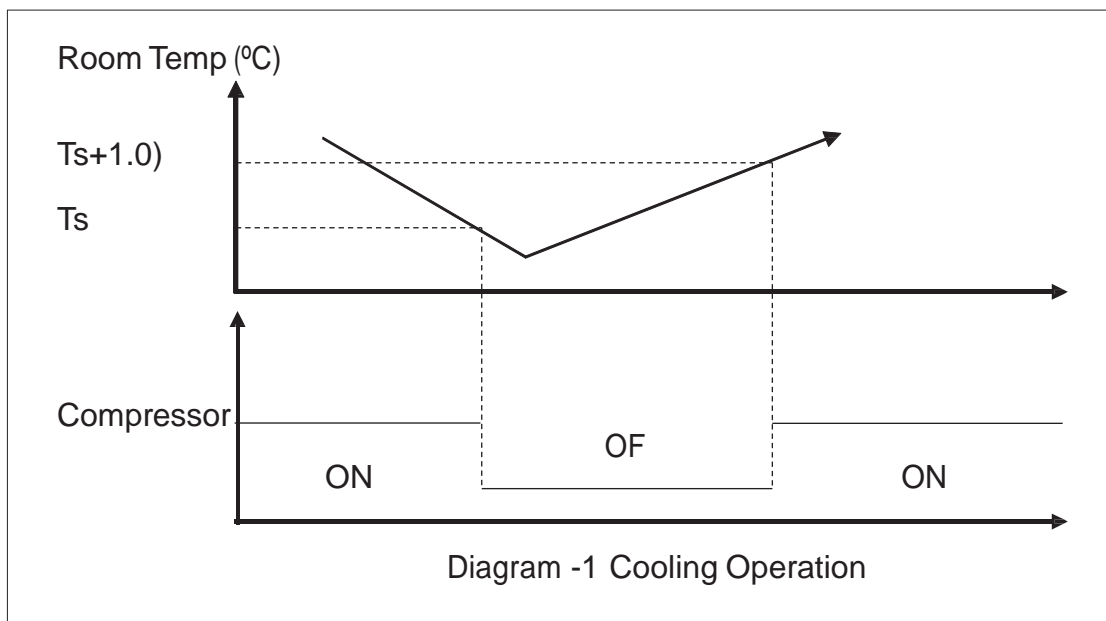

6.2 Cooling Operations With Auto Fan Speed

Fan speed automatically varies according to the difference between T_s and room temperature.

Room Temp $- T_s \geq 2.5^\circ\text{C}$ (3°C) Indoor fan speed High

2.5°C (3°C) $>$ Room Temp $- T_s \geq 1.5^\circ\text{C}$ (2°C) Indoor fan speed Med

Room Temp $- T_s < 1.5^\circ\text{C}$ Indoor fan speed Low

6.3 Cooling Operation in Turbo Mode

- If turbo operation is selected during cooling mode, compressor is operated for 30 minutes regardless of room temperature.
- After 30 minutes, the air conditioner is reset automatically to the previous mode (Cooling, heating or Auto), temperature and fan settings.
- If you press the turbo button in drying or fan mode, the mode is changed with Auto mode automatically.
- If you press the turbo button in Auto mode and if the room temperature is over 21°C , the unit cools your room for 30 minutes regardless of room temperature. Refer to "Auto Mode" section.
- If you wish to stop the Turbo mode before the end of the 30 minute period, press the turbo button again.

Compressor continuous operation for 30 minutes regardless the room temperature.

⚠ Freezing Prevention control (Low temperature release) has priority over COMP, Outdoor and Indoor fan control.

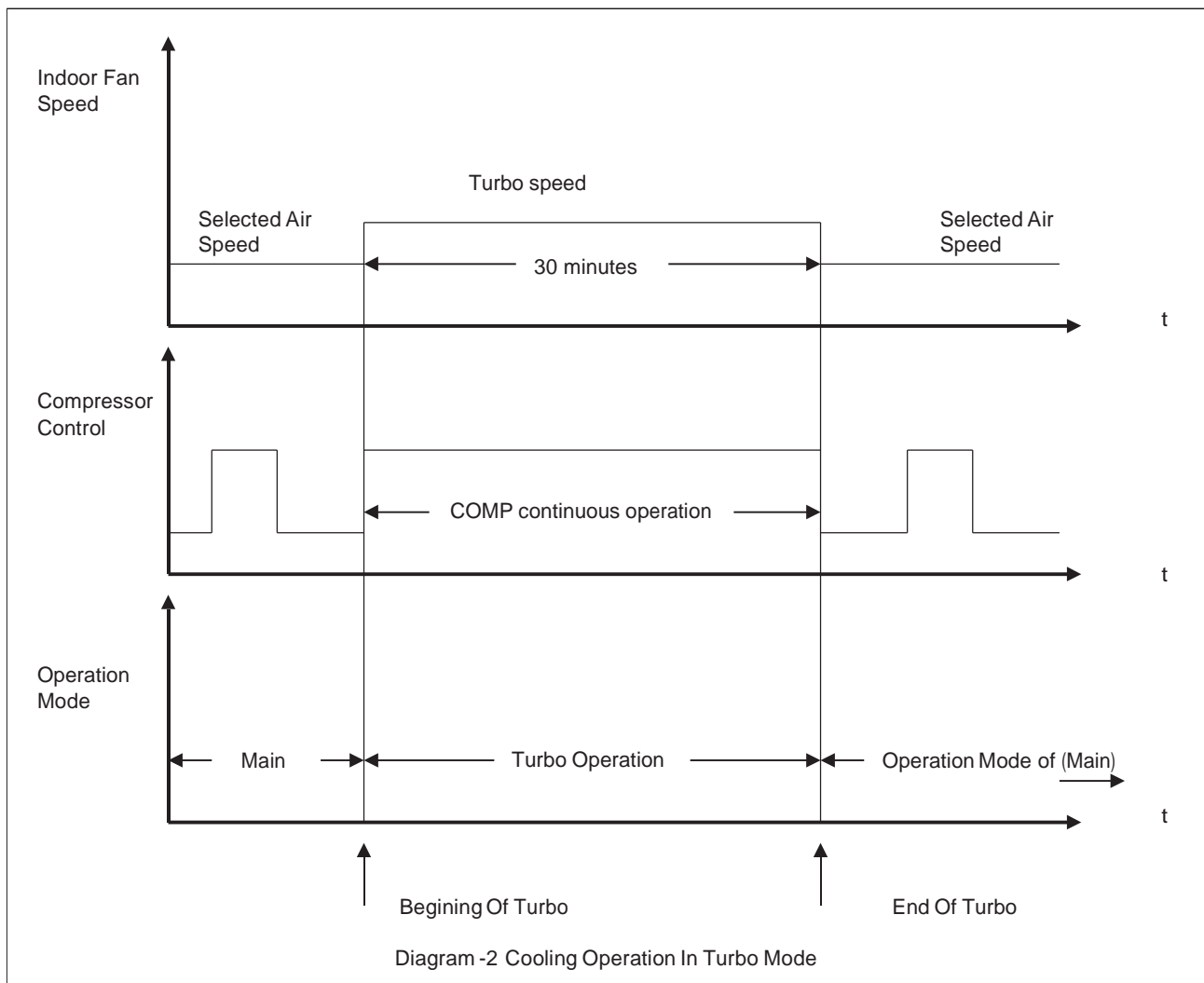

6.4 Heating operation

Heating Operation Control With Selected Fan Speed

The unit operates according to the difference between the setting and room temperature.

When Room Temp \geq Ts+5°C, Thermo OFF condition

Compressor OFF, Outdoor fan OFF. 4-way valve ON

Indoor fan motor >>> Cold air prevention control (LL Speed)

NOTE:

- Outdoor fan stops after 2 seconds than the compressor.
- 4-way valve continues to be on position for 55 second after the operation is stopped by the RC (this is also valid for mode transition from heat or auto heat to any mode)

The valve stops at the end of 55 sec.

When Room Temp \geq Ts+3°C, Thermo ON condition

COMP ON, Outdoor fan ON. (4-way valve still ON)

Indoor fan motor >>> selected fan speed & cold air prevention control & overload prevention control

NOTE:

Compressor begins to operate after 2 seconds than the outdoor fan.

⚠ Cold air prevention control has priority over Indoor fan control.

⚠ Overload protection control (High temperature Release) has priority over Indoor fan, Outdoor fan and Compressor control.

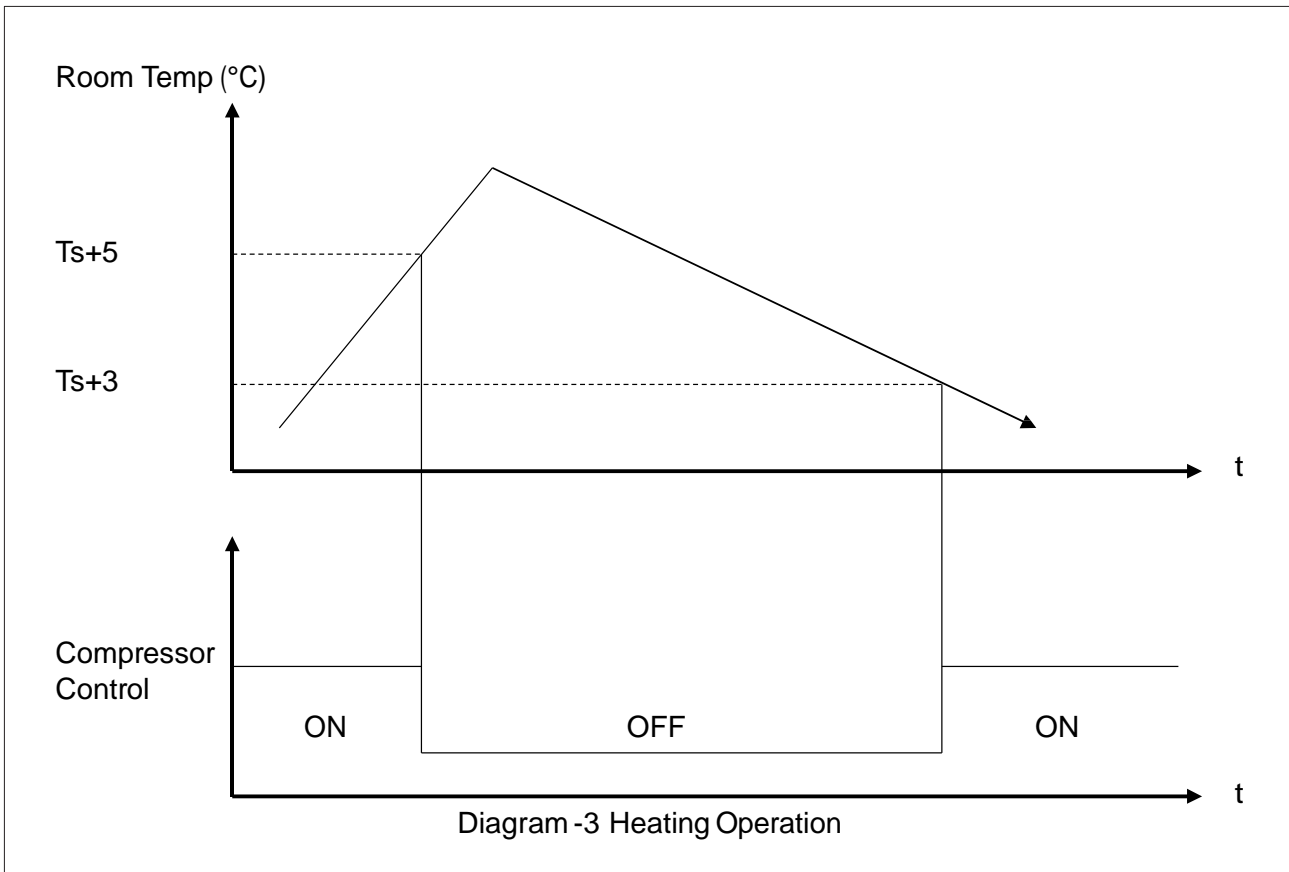

6.5 Heating Operation Control With Auto Fan Speed

⚠ Important: Cold air prevention control has priority over Indoor fan control.

⚠ Overload protection control (High temperature Release) has priority over Indoor fan, Outdoor fan and Compressor control.

Fan speed automatically varies according to the difference between T_s and room temperature as below:

$$\begin{aligned} (T_s + 5^\circ\text{C}) - \text{Room Temp} \geq 2^\circ\text{C} & \text{ Indoor fan speed High} \\ 0 \leq (T_s + 5^\circ\text{C}) - \text{Room Temp} < 2^\circ\text{C} & \text{ Indoor fan speed Med} \end{aligned}$$

6.6 Heating Operation in Turbo Mode

- If turbo operation is selected during heating mode, compressor is operated for 30 minutes regardless of room temperature.
- After 30 minutes, the air conditioner is reset automatically to the previous mode (Cooling, heating or Auto), temperature and fan settings.
- If you press the turbo button in drying or fan mode, the mode is changed with Auto mode automatically.
- If you press the turbo button in Auto mode and if the room temperature is below 21°C , the unit heats your room for 30 minutes regardless of room temperature. Refer to "Auto Mode" section.
- If you wish to stop the Turbo mode before the end of the 30 minute period, press the turbo button again.
- After turbo button is pressed during heating mode, the unit will operate as described below:

Fan speed >>> Turbo fan speed 1250 rpm. (for 18000 BTU/h)
COMP continuous operation for 30 minutes regardless the room temperature

⚠ Cold air prevention control has priority over Indoor fan control.

⚠ Overload protection control (High temperature Release) has priority over Indoor, fan, Outdoor fan and Compressor control.

6.7 Defrosting Operation

Defrost operation is controlled by sensing the temperature of indoor heat exchanger. When outside temperature is low and humidity is high, frost may form in the outdoor unit when heating with the air conditioner. If this happens, the heating operation is stopped. Defrosting mode starts for about 7 minutes. The operation indicator on the indoor unit lights up red. The compressor operates in a reverse cycle to remove exterior ice in a "HEAT" mode. Outdoor fan and indoor fan do not operate intermittently.

- During this, "dF" symbol is lit on the display. Indoor fan stops and flap closes.
- Horizontal louver fully closes and stops during defrosting cycle.
- If it becomes "Operation OFF" during defrosting operation, first of all;
 1. finish the defrosting operation,
 1. then turn off compressor, turn off the operation lamp, close the blade. turn off the indoor fan.

In case of power failure during defrosting operation, reset defrost conditions. When the power is on again, start heating mode again with the previous settings.

NOTE: The "operation off" that carried out by the RC shouldn't be stored in memory for defrost Note : The "operation off" that carried out by the RC shouldn't be stored in memory for defrost

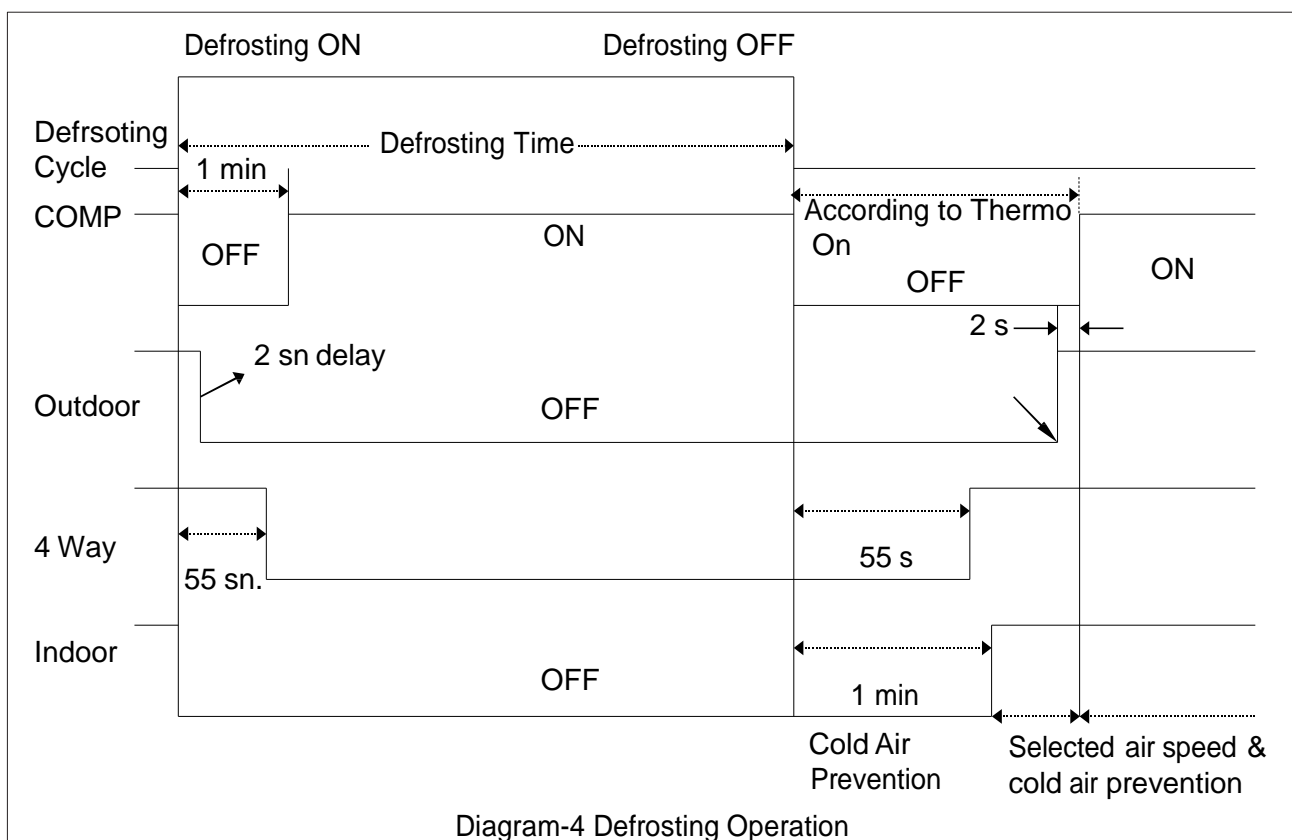

6.8 Automatic Operation Control

With your remote control, you may start operating your air conditioner in automatic mode. When in automatic mode, your air conditioner automatically selects the operation mode according to the ambient temperature.

When Automatic mode is selected, the air conditioner senses the room temperature and automatically selects the operation mode and setting temperature.

The standard setting temperature and optimum fan speed is selected automatically. You can adjust the standard setting temperature but not the fan speed.

| Standard Setting Temperature | Operating Mode | Setting Temp | ΔT |
|------------------------------|----------------|-------------------------------------|-------------------|
| 21°C + ΔT | Cooling | $T_s = 24^\circ\text{C} + \Delta T$ | -2, -1, 0, +1, +2 |
| | Heating | $T_s = 22^\circ\text{C} + \Delta T$ | |

When Cooling or Heating mode is selected in the process of "Automatic Operation", it is not changeable from cooling to heating or reversely according to rising or falling of room temperature during Automatic operation. For example; during cooling operation in Automatic mode, even if the room temperature unexpectedly decrease below 21°C, the operation mode does not change from cooling to heating.

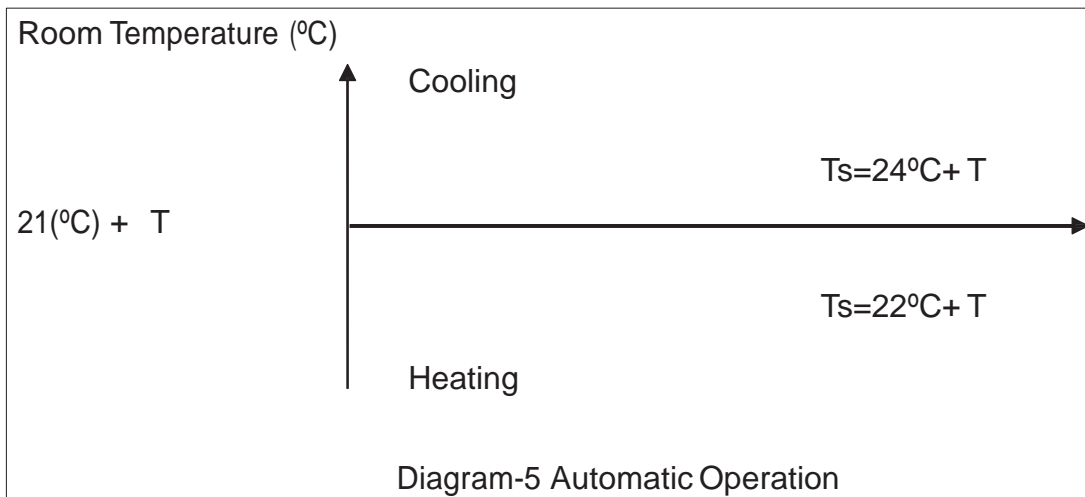

6.9 Cooling Mode

When Room Temp $\geq 21^{\circ}\text{C} + \Delta T$ >>> Set the desired temperature $T_s = 24^{\circ}\text{C} + \Delta T$
 T_s = Remote controller setting temperature

$\Delta T = \pm 2^{\circ}\text{C}$, this means the “Standard Setting Temperature” and T_s can be changed within the limits $\pm 2^{\circ}\text{C}$.

After the air condition fix the T_s

When Room Temp $\leq T_s$, Thermo OFF condition, COMP OFF, Outdoor fan OFF.

Indoor fan motor High speed >>> 1250rpm (for 18000 BTU/h)

NOTE: Outdoor fan stops after 2 seconds than the compressor.

When Room Temp $\geq T_s + 1^{\circ}\text{C}$, Thermo ON condition

COMP ON, Outdoor fan ON.

Indoor fan motor >>> Med speed 970rpm (for 18000 BTU/h)

NOTE: Compressor begins to operate after 2 seconds than the outdoor fan.

⚠ **Freezing Prevention control (Low temperature release) has priority over COMP, Outdoor and Indoor fan control.**

6.10 Heating Mode

When Room Temp $< 21^{\circ}\text{C} + \Delta T$ à Set the desired temperature $T_s = 22^{\circ}\text{C} + \Delta T$

T_s = Remote controller setting temperature

$\Delta T = \pm 2^{\circ}\text{C}$, this means the “Standard Setting Temperature” and T_s can be changed within the limits $\pm 2^{\circ}\text{C}$.

After the air condition fix the T_s :

4-way valve on , COMP OFF, Outdoor fan OFF.

Indoor fan motor >>> Cold air prevention control

NOTE: Outdoor fan stops after 2 seconds than the compressor.

When Room Temp $\geq T_s + 3^{\circ}\text{C}$, Thermo ON condition

4-way valve on , Outdoor fan ON, COMP ON.

Indoor fan motor >>> Cold air prevention control & overload prevention control & Fan speed automatically varies according to the difference between T_s and room temperature as below:

$T_s + 5^{\circ}\text{C}$) – Room Temp $\geq 2^{\circ}\text{C}$ >>> Indoor fan speed High

$0 \leq (T_s + 5^{\circ}\text{C}) - \text{Room Temp} < 2^{\circ}\text{C}$ >>> Indoor fan speed Med

NOTE: Compressor begins to operate after 2 seconds than the outdoor fan.

⚠ **Cold air prevention control has priority over Indoor fan control.**

⚠ **Overload protection control (High temperature Release) has priority over Indoor fan, Outdoor fan and Compressor control.**

6.11 Freezing Prevention Control

Indoor unit fan speed is controlled according to the indoor unit exchanger temperature. The aim of this control is to prevent cold air exit. This is also called hot start. Hot start is installed in order to protect the customer from cold air. Firstly outdoor unit is activates, indoor unit exchanger is heated and with this heating, it gives way to the indoor unit fan motor according to the exchanger temperature. Therefore, cold air blowing directly onto the customer is prevented. This operation is performed in three ways as follows.

If the temperature of indoor heat exchanger ≤ 1 degree, and this situation continue for 4 minutes, then enter into freezing prevention: COMP Off, Outdoor fan Off, Indoor fan = LL speed.

During freezing prevention, if the temperature of indoor heat exchanger ≥ 8 °C , then exit from freezing (≥ 7 °C \gg v09) prevention: COMP On, Outdoor fan On, Indoor fan = selected speed.

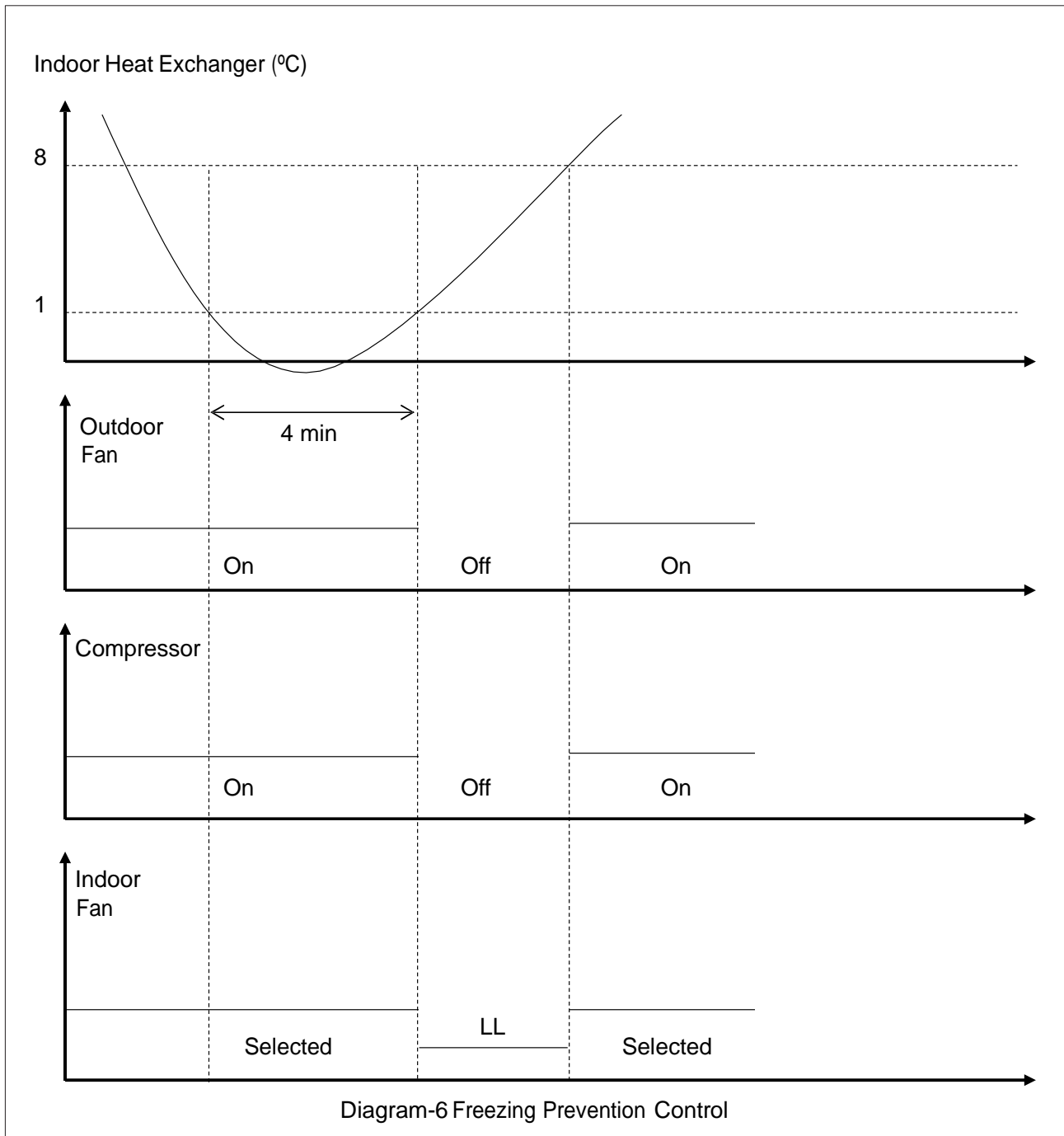

6.12 Dehumidifying operation control

If the atmosphere in the room is very humid, excess humidity can be removed according to the following items without lowering the room temperature too much.

Operation Modes according to Dehumidifying Operation Control:

1. Mode I, When Room Temp $> T_s + 3^\circ\text{C}$
2. Mode II, When $T_s + 1^\circ\text{C} < \text{Room Temp} \leq T_s + 3^\circ\text{C}$
3. Mode III, When $T_s - 1^\circ\text{C} < \text{Room Temp} \leq T_s + 1^\circ\text{C}$
4. Mode IV, When Room Temp $\leq T_s - 1^\circ\text{C}$

Operation Cycles according to Dehumidifying Operation Control:

| Compressor & Outdoor Fan | Operation Cycle (Minute) | | | |
|--------------------------|--------------------------|---------|----------|----------------|
| | Mode I | Mode II | Mode III | Mode IV |
| On Time | 6 | 5 | 3 | Compressor Off |
| Off Time | 4 | 3 | 6 | |

Indoor fan speed >>> LL speed continuously

Check the room temperature in every operation mode, at the time of 3 minutes from COMP ON and decide next operation mode. If the operation mode is changed, the next COMP OFF time will be the COMP OFF time of the New Operation Mode.

In Mode IV, check the room temperature continuously and decide next operation mode.

For the first 6 minutes (including 3 minutes delay) after setting dehumidifying operation, operate COMP ON and Indoor fan LL speed.

6.13 Sleeping Operation Control

- Sleep timer can be selected only by cooling or heating mode.
- Press the sleep timer button.
- The indoor unit beeps.
- The sleep timer indication is displayed on the remote control.
- Cancelling the sleep timer: Press again the sleep timer button. The sleep timer indication is no longer displayed. The air conditioner operates normally

6.13.1 Cooling Sleeping Operation

For the initial 1 hour:

- When Room Temp $\leq T_s$, Thermo OFF condition, COMP OFF, Outdoor fan OFF.
- When Room Temp $\geq T_s+1^\circ\text{C}$, Thermo ON condition, COMP ON, Outdoor fan ON.

For the second 1 hour:

- When Room Temp $\leq T_s+1^\circ\text{C}$, Thermo OFF condition, COMP OFF, Outdoor fan OFF.
- When Room Temp $\geq T_s+2^\circ\text{C}$, Thermo ON condition, COMP ON, Outdoor fan ON.

For the next 4 hour:

- When Room Temp $\leq T_s+2^\circ\text{C}$, Thermo OFF condition, COMP OFF, Outdoor fan OFF.
- When Room Temp $\geq T_s+3^\circ\text{C}$, Thermo ON condition, COMP ON, Outdoor fan ON.

The operation will stop after six hour.

6.13.2 Heating Sleeping Operation

For the initial 1 hour:

- When Room Temp $\leq T_s+5^\circ\text{C}$, Thermo OFF condition, 4-way valve ON, COMP OFF, Outdoor fan OFF.
- When Room Temp $\geq T_s+3^\circ\text{C}$, Thermo ON condition, 4-way valve ON, Outdoor fan, COMP ON.

For the second 1 hour:

- When Room Temp $\leq T_s+4^\circ\text{C}$, Thermo OFF condition, 4-way valve ON, COMP OFF, Outdoor fan OFF.
- When Room Temp $\geq T_s+2^\circ\text{C}$, Thermo ON condition, 4-way valve ON, Outdoor fan ON, COMP ON

For the next 4 hour:

- When Room Temp $\leq T_s+3^\circ\text{C}$, Thermo OFF condition, 4-way valve ON, COMP OFF, Outdoor fan OFF
- When Room Temp $\geq T_s+1^\circ\text{C}$, Thermo ON condition, 4-way valve ON, Outdoor fan ON, COMP ON,

The operation will stop after six hour.

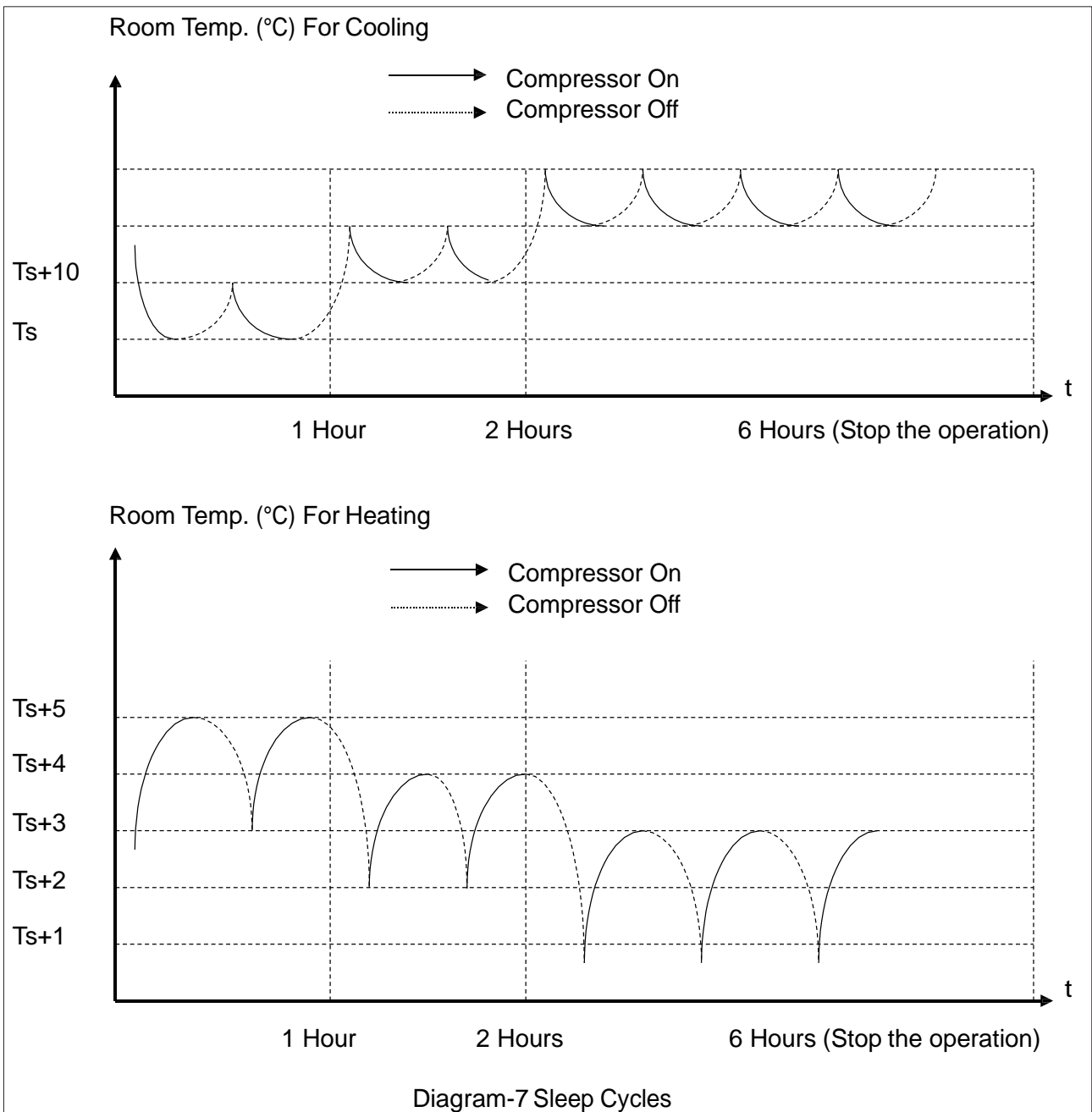

6.14 Ionizer Operation Control

When ionizer is on, ionizer generates ions for 15 minutes and stops for 45 minutes.

NOTE: Even ionizer stops generating ions the ION indication is still displayed.

NOTE: If the indoor fan stops while ion generating is going on, the ion generation stops. When indoor fan starts again, ionization starts its cycle from the beginning

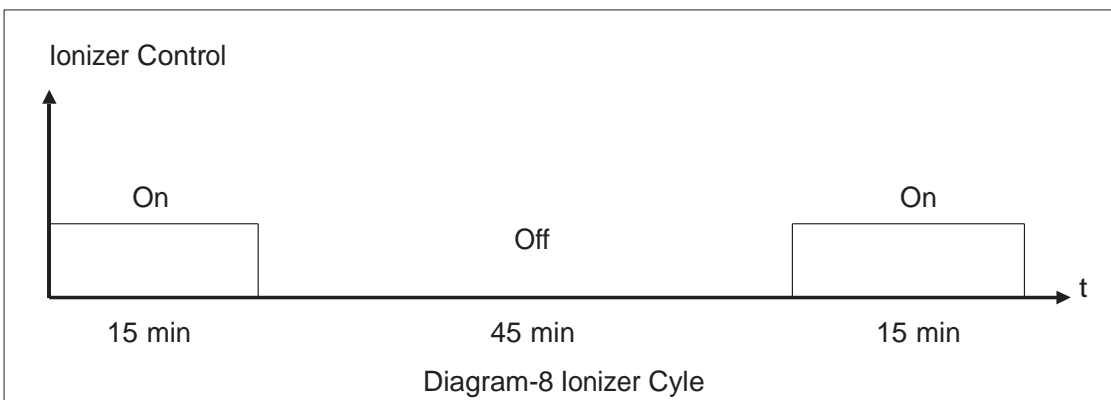

6.15 Ventilating Operation Control

- Press the On/Off button.
- The operation indicator on the indoor unit comes on.
- The air conditioner starts up in the mode selected when the unit was last used.
- The indoor unit beeps.
- Press the mode button one or more times until the fan symbol appears.
- The indoor unit beeps each time you press the mode button.
- The FAN indicator on the indoor unit lights up.
- The air conditioner starts up in Fan mode.

When the unit receives Fan operation signal from remote control:

Outdoor power supply Relay OFF >>> COMP OFF, Outdoor fan OFF.

Indoor fan >>> selected air speed (1,2,3,4,5 Auto)

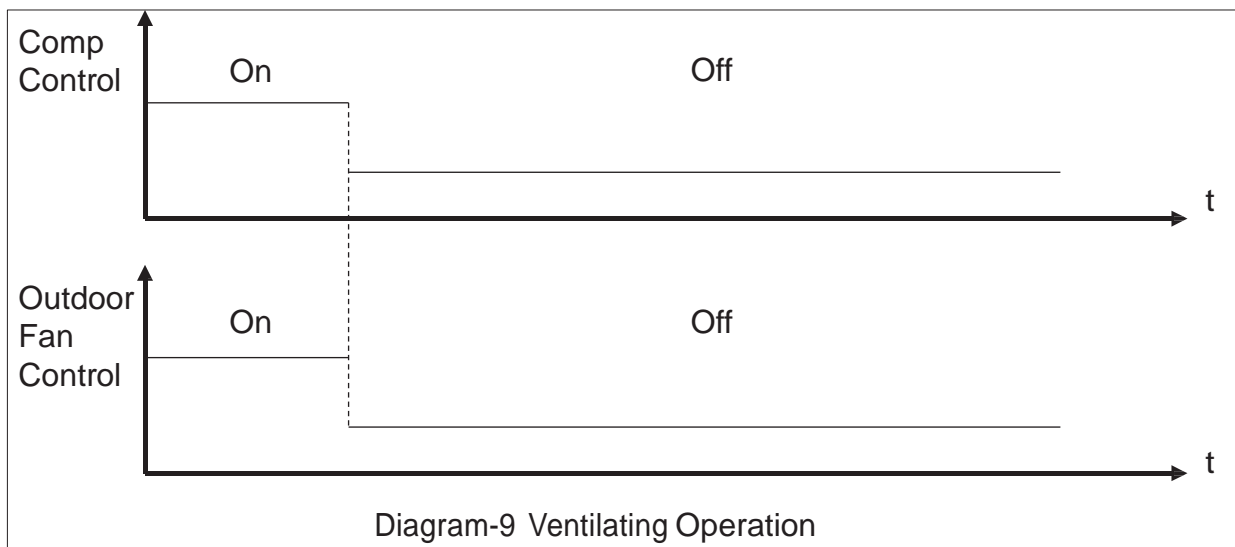

6.16 X-Fan (Self Clean) Operations

Press to button on the remote control to activate the Self Cleaning function

“SC” symbol will be flashing (Blink) on the indoor unit display for 3 seconds then setting temperature will be appeared again.

“SC” symbol will be appeared on the indoor unit display when the user turned-off the air conditioner by the remote. During this time (2 min) the indoor unit fan motor will be run at low speed. “SC” symbol will be shown for 2 minutes.

At the same time, the horizontal louver remains open for 2 minutes.

When the 2 minute period is completed, the indoor fan stops, the louver moves to the fully closed position, the display switches to the fully closed state (air conditioner off state).

6.17 Adjusting the Air Flow Direction Operations

- You can adjust the position of the outer air flow blade on the bottom of the indoor unit, in order to increase the efficiency of the air conditioner.
- Press the blade set button.
- The outer blade is adjusted vertically.
- If you want the blade to move up and down automatically when the air conditioner is operating, press the blade set button again.
- The blade move up and down, around the base position set.
- To stop the blade moving up and down in a desired position, press the blade set button again.

The air flow blade has the same moving area for Auto mode, Cooling, Heating, Dehumidifying, and Fan Modes. The blade has an angle with horizontal plane between 0 and 45 degree. It is possible to stop the blade between 0 and 45 degrees.

While the blade is inactive in any mode with angle between 0 and 45 degrees: If you changed the mode, the blade angle is 30 degree in other modes except dry mode, heating mode and auto-heating mode. Dry mode blade angle is 0 degree. Heating and auto-heating blade angle is 45 (30) degree during thermo on and 0 degree during thermo off.

While the blade is active in any mode:

If you changed the mode, the blade is also active in the other modes.

If the thermo off conditions occurs while the blade move up and down The blade swing turns off. The blade move to Heating mode thermo off default position 0 degree. Even if you press the blade set button again, the blade will not begin to move up and down.

If you switch off the air conditioner, the blade is closed completely.

If the blade is active in the previous mode >>> The blade is active.

the blade is inactive in the previous mode >>> The blade angle is 30 degree in all modes except dry mode, heating mode and auto-heating mode. Dry mode blade angle is 0 degree. Heating and auto-heating blade angle is 45 (30) degree during thermo on and 0 degree during thermo off.

7. PRECAUTIONS

The installation and maintenance must be accordant with the installation manual and instructions. Incorrect operation due to ignoring instruction will cause harm or damage.

Wiring should be done by an expert electric technician according to national regulations on electrical wiring.

All installation and maintenance shall be performed by qualified person.

7.1 Electrical Safety Precautions

18K models power supplied by outdoor unit

- The air conditioner must be grounded.
- Insufficient grounding may cause electric shocks. Do not connect the grounding wire to gas pipes, water pipes, lightning conductors or telephone grounding wire. After mounting, the appliance should be powered up in order to determine grounding leak check. If you neglect, it may cause electric shocks and damages in the product.
- In order to prevent overloading of the electrical circuit, do not operate any other high-power appliance on the same circuit. Do not connect with extension cables or multi plugs. If you neglect, it may cause electric shocks or damages in the air conditioner.
- Use a dedicated mains circuit for the AC.
- Do not use a damaged or low value circuit breaker.
- Make sure that the live wire, the neutral wire and the ground wire in the mains socket are properly connected.
- Inadequate or incorrect electrical connections can cause electric shock or fire.
- Do not change the power cord or extend it with improper addition.
- The unit is a type I electrical appliance. Make sure that the unit is properly grounded. The yellow-green wire is the ground wire that cannot be used for other purposes. Improper grounding can cause electric shock.
- The unit must be reliably earthed and connected to the special earth device by the qualified electrician.
- The ground resistance must comply with local regulations.
- The mains supply must have reliable ground terminal. Do not connect the ground wire to water pipes, gas pipes, contamination pipes or other possible unsafe places.
- Fuses must comply with the prescribed model and rating printed on the fuse cover or circuit board.
- If the length of the power cord is not enough, please contact your supplier for new power cord. Lengthen the power cord by yourself is not allowed.
- Do not connect two power cables together to supply power to the air conditioner.
- Do not extend the power cable conductor by cutting.

7.2 Installation Safety Precautions

- After the mounting, electrical switch/fuse should be easily accessible.
- Do not install the unit in areas with strong heat sources, vapours or flammable gasses, contamination with oil particles, high frequency electromagnetic equipment (e.g. welding equipment or medical devices), high salinity (e.g. close to coastal areas), sulphuric gas (e.g. hot water springs), poor air quality.
- Install the indoor and outdoor unit out of reach of children.
- The wall must be strong enough to support the weight and vibration of the unit.
- Leave at least 1 m distance between the unit and other electrical appliances.
- Wear safety belt if the height of working is above 2m.
- Do not touch the product with wet hands.
- Do not allow water to run into electric parts.

7.3 Transportation Safety Precautions

- During handling and transportation of your air conditioner, watch out the ARROW sign while handling the indoor unit.
- Do not step on and do not put heavy objects on the indoor and outdoor unit boxes.
- Carry the outdoor unit vertically and keep it vertically at the place it is stored.
- Do not carry the outdoor unit only one person.

7.4 Product Description

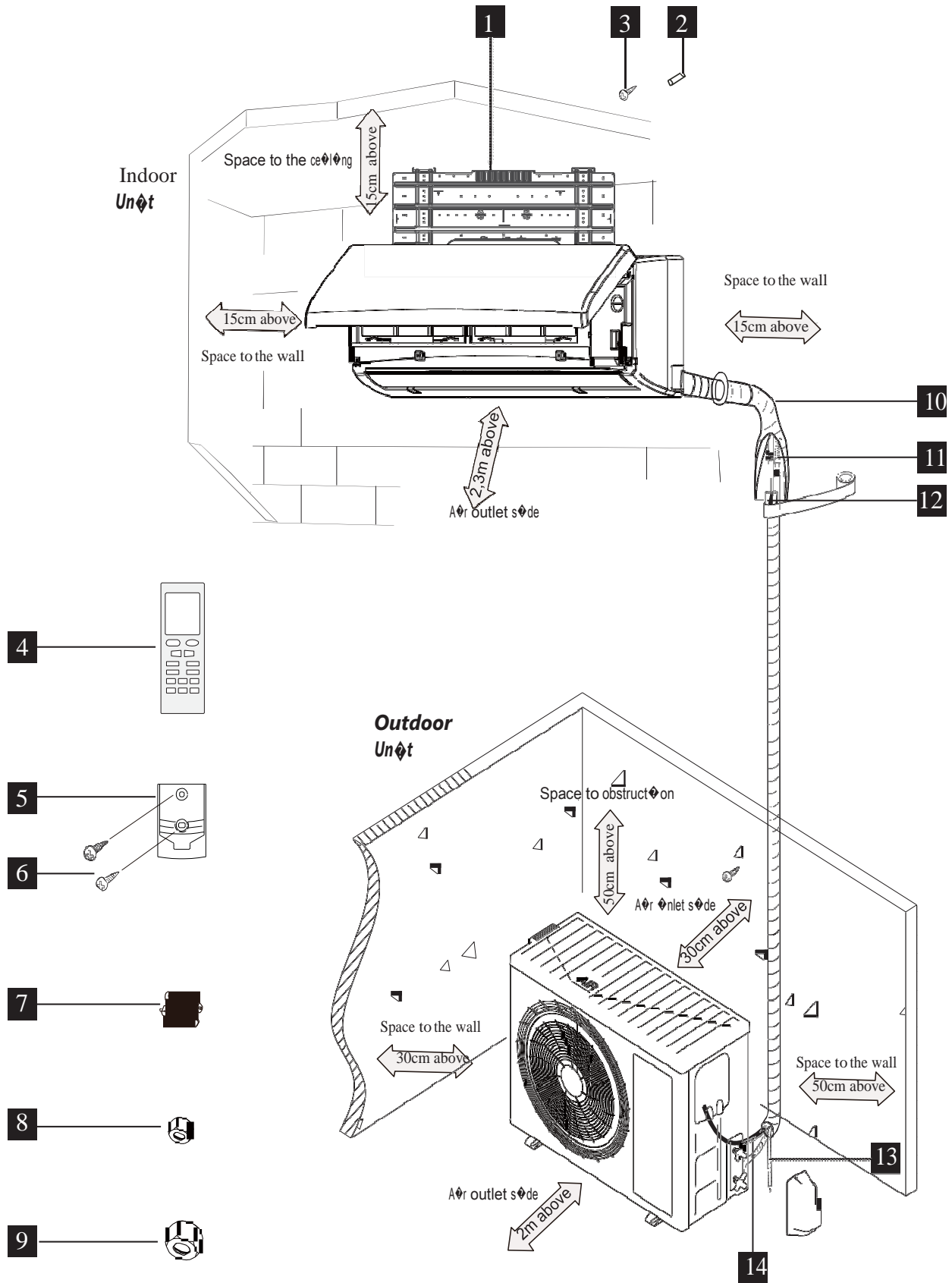

All the pictures in this manual are for explanation purposes only. The actual shape of the indoor unit you purchased may be slight different on front panel and display window. The actual shape shall prevail.

8. BEFORE INSTALLATION

8.1 Tools needs for installation

1. Level gauge
2. Electric drill
3. Hole core drill (ø55mm / ø70mm)
4. Flaring tool set
5. Specified torque wrenches
6. Spanner (half union)
7. A glass of water
8. Hexagonal wrench (5mm)
9. Gas-leak detector
10. Vacuum pump
11. Gauge manifold
12. Users manual
13. Thermometer
14. Multimeter
15. Pipe cutter
16. Measuring tape
17. Screw driver (Phillips and slotted)
18. Pliers and flash cutter
19. Socket wrench set & allen wrench set
20. Allen tools
21. Rubber wedge hammer
22. Adjustable spanner
23. R410A Gas tank
24. Extension cable
25. Vinyl tape
26. Gas charge hose & scales
27. Plaster & spatula
28. Pipe bending kit

8.2 Accessories

| Number | Name of Accessories | Quantity |
|--------|--|-------------------------------|
| 1 | Indoor unit mounting plate | 1 |
| 2 | Clip anchor | 6 |
| 3 | Self-tapping screw | 6 |
| 4 | Remote control | 1 |
| 5 | Remote control holder | 1 |
| 6 | Screw for remote holder | 2 |
| 7 | Battery (AAA 1.5V) | 2 |
| 8 | Flare nut (for liquid pipe) | 1 |
| 9 | Flare nut (for gas pipe) | 1 |
| 10 | Decorative tape | 1 |
| 11 | Connection piping assembly | 1 |
| 12 | Insulation hose for refrigerant piping | 1 |
| 13 | Drain hose | 1 |
| 14 | Interconnection cable | 1 (2 cables for 18K HP model) |
| 15 | External power cable | 1 |

Note: Other necessary parts for the installation, besides the above mentioned, must be provided by the customer/installer.

8.3 Installation details

8.3.1 Wrench torque sheet for installation

| Outer Diameter (mm) | Torque (N.m) | Additional Torque (N.m) |
|---------------------|--------------|-------------------------|
| Ø 6,35 (1/4") | 15(1.53kg.m) | 17(1.73kg.m) |
| Ø 9,52 (3/8") | 34(3.47kg.m) | 37(3.77kg.m) |
| Ø 12,70 (1/2") | 50(5.1kg.m) | 54(5.5kg.m) |
| Ø 15,88 (5/8") | 68(6.95kg.m) | 72(7.34kg.m) |

8.3.2 Connecting the cables

| Capacity Watts / Btu/h | System Voltage/ Frequency | Power Cord Cable Gauge (mm ²) | Connecting Cable Gauge (mm ²) | Fuse Type (A) | Circuit Breaker (A) |
|---------------------------|------------------------------|--|--|------------------|------------------------|
| 5500/18000(HP) | 220-240V/50Hz. | 2,5 | 1+0,75 | 6,3 | 20 |
| 5500/18000(CO) | 220-240V/50Hz. | 2,5 | 1 | 6,3 | 20 |

8.3.3 Electrical wires

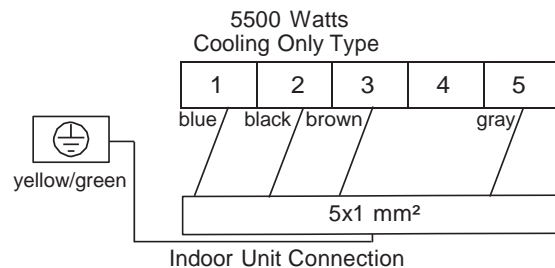
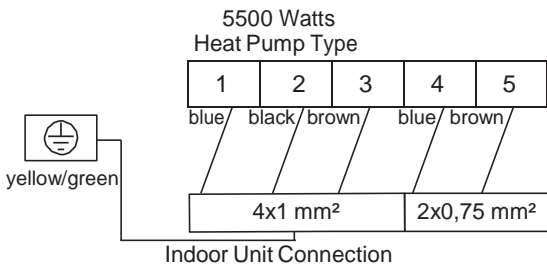
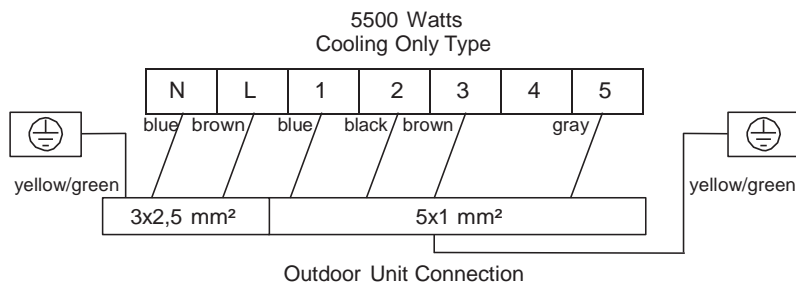
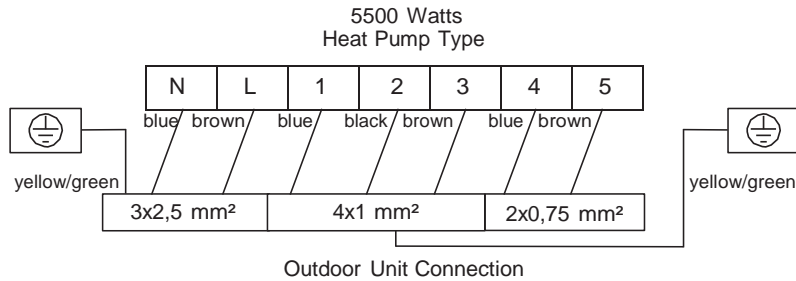

8.3.4 Piping length and the elevation

| Capacity Watts / Btu/h | Suction/Discharge Pipe Diameter (mm) | Standard Length (m) | Maximum Length (m) | Maximum Height (m) (A) | Additional Refrigerant (g/m) |
|---------------------------|---|------------------------|-----------------------|---------------------------|---------------------------------|
| 5500/18000(HP) | Ø12.7(1/2")-6,35(1/4") | 4 | 20 | 10 | 20 |
| 5500/18000(CO) | Ø12.7(1/2")-6,35(1/4") | 4 | 20 | 7 | 20 |

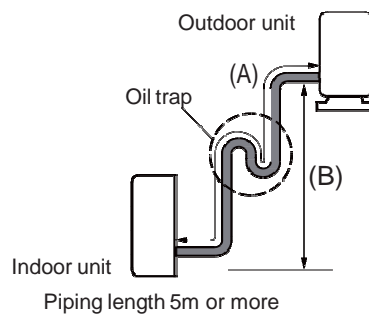
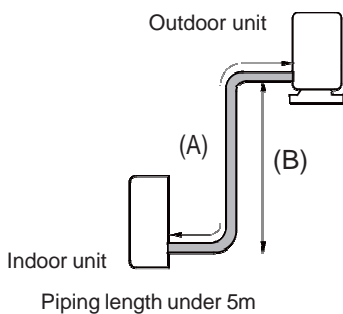

8.3.5 Important Installation Informations

- In order to avoid extraordinary noise and vibration, the authorized service personnel must apply a proper fixation of the air conditioner.
- Do not block the air inlet or the air outlet.

- Do not use the unit in places with extremely high humidity.
- The wall must be strong enough to support the weight and vibration of the unit.
- Install the indoor unit at least 230 cm above the floor surface.
- The air filter should remain accessible.
- Install the indoor unit in a place where the condensate water can be easily drained.
- Considering the wall structure, the outdoor unit should be installed on a flat surface to avoid raspy noise, echo and vibration.
- Choose a place that will not take direct sunlight. If the selected place is exposed to direct sunlight, the outdoor unit should be shaded.
- Install the unit at the site where it is exposed to as little wind as possible, especially in areas where it is frequently windy.
- If the installation site is exposed to heavy winds, such as in coastal areas, place the unit along the widest part of the wall or use protective plates.
- Select a dust-free location where the air flow is good, which will not obstruct the air inlet and outlet of the appliance.
- Choose a place that can be easily assembled. It should be ensured that the selected location is a place where the possible service intervention can be made easily.

⚠ It is strictly forbidden to place the outdoor units on the ground. If it needs to be placed on the ground, mounting must be done on the console of the outdoor unit by installing the console to the nearest distance of the ground. If this situation is not possible, mounting must be done above the rubber wedges with screw.

8.4 Installation Summary

You can see the summary of installation below. For other details and installation visuals, please refer to the supplied installation manual.

8.4.1 Indoor Unit Installation

Installation the Wall Mounting Bracket

- The mounting plate of the indoor unit is removed from the product
- The location of the installation is determined. The distance of the product from the ceiling should be adjusted to a minimum of 15 cm. Install the wall mounting bracket horizontally over the structural parts on the wall using the spaces indicated on the bracket. Balancing must be done with water level gauge during the process.

Drilling the Hole

- While the holes required for mounting the mounting plate is marked, the indoor unit wall plate is used as a template.
- The location of the holes which the connection pipes and the drain hose will located is determined.

Connective Pipes

- Cut out the marked area from the right side or left side of the rear body with a saw, etc. Smooth the cut edges.
- The indoor unit connection pipe should be moved slowly and manually supported from the corner in order to avoid damage to the pipe when opening and bending. Pipe bending is very critical, especially when the pipe outlet is from the right side.
- Improper bending operation of the pipes may cause cracking, rupture, constriction or excessive noise of refrigerant flow.

Drainage

- If the product have double drainage pipes outlet (for 18K BTU/h products), give the mounting plate some inclination (1 - 2 degrees) in which direction the water discharge hose will come out.
- The outlet direction and the slope of the drain hose must be taken into account while opening a hole through which the pipes will pass.
- If there is only one drainage pipes outlet direction in the drain pan, there is no need to tilt this outlet. Because there is the required slope inside the pan.

Fastening the Indoor Unit

- Pass the piping through the hole in the wall.
- Put the upper claw at the back of the indoor unit on the upper hook of the wall mounting bracket, move the indoor unit from side to side to see that it is securely hooked.
- Push the lower part of the indoor unit up on the wall, then move the indoor unit from side to side, up and down to check if it is hooked securely.

Piping and Wrapping

- Bundle the tubing, connecting cable, and drain hose with tape securely and evenly as shown in the side ward figure.
- Because the condensed water from rear of the indoor unit is gathered in ponding box and is piped out of room, do not put anything else in the box.

8.5 Outdoor Unit Installation

- During heating operation, the condensate and defrosting water should be drained out reliably through the drain hose.
- In case of a drain hose, the unit must be installed on a base more than 5 cm height.

8.5.1 Flaring Work

Main cause for refrigerant leakage is due to defect in the flaring work. Carry out correct flaring work using the following procedure:

- Cut the pipes and the cable.
- Use the piping kit accessory or pipes purchased locally.
- Measure the distance between the indoor and the outdoor unit.
- Cut the pipes a little longer than the measured distance.
- Cut the cable 1m longer than the pipe length.

8.5.2 Burr Removal

- Burrs not removed may result in leakage of gas.
- Remove burrs at the tip of the pipe cut.
- Put the end of the copper tube/pipe in a downward direction as you remove burrs in order to avoid dropping burrs into the tubing.

8.5.3 Put Nut on

Remove flare nuts attached to indoor and outdoor unit, then put them on pipe/tube having completed burr removal. (It is not possible to put them on after flaring work.)

8.6 Piping Connection Summary

8.6.1 Indoor Unit

- Connecting the indoor unit tubing to the connection piping:
 - Align pipes to be connected. Sufficiently tighten the flare nut with fingers, and then tighten it by using wrenches.
 - Then tighten the flare nut with spanner and torque wrench.
- Wrap the insulation material around the connecting portion:
 - Cover the indoor unit pipe and the connection pipe with the heat insulation material. Bind them together with vinyl tape so that there is no gap.
 - Ensure to isolate separately the suction pipe from the liquid pipe.
 - Wrap the insulated pipes with vinyl tape in the rear section for pipe housing. Fasten the power cable to the pipes with vinyl tape.
 - Wrap the piping, drain hose and power cable tightly with vinyl tape so that they can fit into the rear piping housing section.
- Connecting the indoor unit tubing to the connection piping:
 - Remove the spacer.
 - Hook the indoor unit onto the upper portion of the mounting plate (Engage the hooks of the mounting plate into the openings at the rear top of the indoor unit).
 - Ensure that the hooks are properly seated on the mounting plate by moving the indoor unit in all directions.
 - Press the lower left and right sides of the unit against the mounting plate until the hooks engage into their slots (clicking sound).

8.6.2 Outdoor Unit

- Align pipes to be connected. Sufficiently tighten the flare nut with fingers, and then tighten it by using wrenches as shown.
- Then, tighten the flare nut with torque wrench until the wrench clicks.
- Make sure to follow the above torque table value.

8.6.3 Piping Formation

- Form the piping by wrapping the connecting portion of the indoor unit with insulation material and secure it with narrow vinyl tape and wide vinyl tape.
 - If you want to connect an additional drain hose, the end of the drain hose outlet should be routed above the ground. Secure the drain hose appropriately.
- In cases where the outdoor unit is installed below the indoor unit level:
 - Wrap the piping, drain hose and connecting cable from the down to up.
 - Secure the wrapped piping along the exterior wall using saddle or equivalent.
- In cases where the outdoor unit is installed above the indoor unit level:
 - Wrap the piping and connecting cable from the down to up.
 - Form a trap to prevent water from entering the room.
 - Secure the wrapped piping along the exterior wall using saddle or equivalent.

8.6.4 Checking the Drainage

- Open and lift the indoor unit front panel.
- Check the drainage
 - Carefully pour a glass of water on the evaporator.
 - Ensure the water flows through the drain hose of the indoor unit without any leakage and goes out the drain exit.
- Drain piping
 - The drain hose should point downward for easy drain flow.

8.7 Installation of Electrical Wires Summary

8.7.1 Installation of Indoor Electric Wires

- Open the front panel and remove the wiring cover by loosening the screw.
 - Route the power connection cable and signal control wire (for heap pump model only) from back of the indoor unit and pull it toward the front through the wiring hole for connection.
- Connect and screw the wires onto the terminal block as identified by their colours.
- Wrap wires that are not connected with insulating tape so that they do not touch any electrical or metal parts
 - Secure the wires firmly with the cable clamp.
 - Put the wiring cover back and screw it.
 - Reinstall the front panel.
 - Do not extend the power cable conductor by cutting.

8.7.2 Installation of Outdoor Electric Wires

- Remove the terminal cover on the right side plate of outdoor unit by loosening the screw.
- Take off wire cable clamp. Connect and screw the power connection cable and signal control wire (for heap pump model only) onto the terminal block following corresponding identification numbers and colours on the terminal blocks of indoor and outdoor units.
- To prevent water from entering, make a trap ("U") in the connection wires
- Wrap wires that are not connected with insulating tape so that they do not touch any electrical or metal parts.
- Fix the power connection wires with wire clamps.
- Reinstall the handle.

NOTE: After confirming the above conditions, prepare the wiring as follows:

- The screws which fasten the wiring to the terminal block may come loose from vibrations during transportation.
- Check and make sure all screws are well fixed. Otherwise, it could burn-out of the wires.
- Be sure the circuit capacity is sufficient.
- Ensure the starting voltage is maintained at over 90% of the rated voltage marked on the nameplate.
- Confirm that the cable thickness is as specified in the power source specification.
- Always install a Residual Current Device (RCD) in wet or moist area.
- The following may be caused by voltage drop: Vibration of a contactor, which will damage the contact point, fuse blowing, disturbance of the normal function of the overload.
- The means for disconnection from a power supply shall be incorporated in the fixed wiring and have an air gap contact separation of at least 3mm in each active (phase) conductor.

9. NEW REFRIGERANT (R410A)

Formula : 50% R32 (CH₂F₂) + 50% R125 (CHF₂CF₃)

The most notable difference between R-410A and R-22 is the higher operating pressures (approximately 50% higher on both the discharge side and the suction side).

For example, a high-efficiency air conditioners R-22 typically operates with a suction pressure of about 5 bars and a discharge pressure of about 17 bars at an outdoor temperature of 35°C. With R-410A, the same unit will operate under the same conditions with a suction pressure of 8 bars and a discharge pressure of 27 bars. (Note that in most cases, equipment designed for R-22 cannot use R-410A because of this difference in operating pressures, so retrofitting an existing R-22 system is normally not an option.)

Today R-410A is most popular refrigerant in HVAC field both because it is an HFC (hydro fluorocarbon), and because its greater efficiency allows for the design and use of smaller air conditioning equipment.

R-410A is an azeotropic mixture of HFC-32 and HFC-125. It has been developed as a long-term replacement for R-22 in a variety of new air conditioning and cooling equipment. R-22 is an HCFC, or hydro chlorofluorocarbon, which means that it contains chlorine, an element that is depleting to the ozone layer. Because R-410A contains no chlorine at all, its ozone depletion potential (ODP) is zero. R-410A comes in rose-coloured cylinders. The “rose” colour is PMS (Pantone Matching System) 507.

As with any refrigerant, there are certain safety precautions that the technician needs to understand and observe. This article describes typical applications, recycling/recovery procedures and equipment, and precautions applicable to this new refrigerant product.

9.1 Typical Applications

Major applications for R-410A include unitary air conditioning equipment, chillers, and commercial refrigeration systems. In unitary residential and light commercial systems, R-410A has demonstrated a 5 to 6% higher energy efficiency rating (EER) than R-22. Its higher cooling capacity permits smaller, more compact units to be used.

Because of the significantly higher pressures associated with R-410A, a typical compressor designed for R-22 cannot be used with R-410A. As noted previously, this fact—along with other components in the system that would need to be changed—renders the refrigerant inappropriate for retrofit of existing R-22 systems.

Another important issue is the compatibility of the compressor lubricant with the azeotropic R-410A mixture. To ensure satisfactory operation and durability, a polyester based lubricant that is miscible with the refrigerant is recommended.

Compressor manufacturers are continuing to test and recommend specific lubricants for use with R-410A. It is therefore important to contact the compressor and/or equipment manufacturer to review system lubricant requirements.

It is also important to review materials with which the refrigerant will come in contact, including motor windings in hermetic and semi-hermetic compressors, gaskets, etc., for compatibility.

R-410A and R-22 are chemically compatible—which means that they will not react or form other compounds if accidentally mixed—but they will form a mixture that can be difficult to separate.

At this time, separation cannot be accomplished by any known on-site recovery device or in the facilities of most offsite reclaimers. Disposal of the mixture by incineration is recommended.

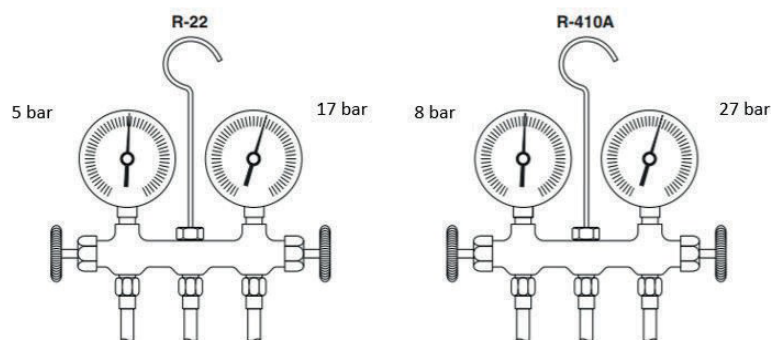

Operating Pressures

In order to prevent the damage to equipment that can be caused by charging with contaminated refrigerant, cross contamination (the mixing of R-410A with other refrigerants) should be avoided during recovery and recycling. Recovery equipment includes not only the recovery/recycling machine itself, but also all equipment that comes into contact with the refrigerant during recovery and reclamation. This may include hoses, storage cylinders, vacuum pumps, manifold gauges, and scales.

To eliminate the possibility of cross contamination, the technician should use recovery/recycling devices with self-purging or evacuation features. Such equipment contains special valves that work with internal compressors to remove refrigerant by creating a partial vacuum in the tanks and hoses, thus allowing for the complete removal and diversion of materials into the recovery cylinder. Hoses, cylinders, and manifold gauges should either be dedicated to R-410A or evacuated after each recovery job. All equipment should be clearly marked to indicate the formulation for which it can be used, and all new cylinders should be evacuated prior to the first use.

Proper maintenance of vacuum pumps, used to remove non condensable gases and moisture from a system, is equally important. New (clean) oil specifically formulated for vacuum pumps should be used at the start of each procedure. The oil should be changed at intervals as recommended by the manufacturer, or more frequently if it takes on a milky or cloudy appearance. An isolation valve is an absolute necessity for checking system integrity. In addition, worn O-rings and hoses should be replaced to ensure minimal manifold leakage during evacuation. Vacuum pumps should be capable of pulling a vacuum of 300 to 500 microns. Scales are sometimes used during recovery to prevent tank overfilling. If the scale is equipped with an automatic solenoid shut off, it must be purged prior to each use.

9.2 Safety Precautions

Because it is heavier than air, R-410A vapours can accumulate at ground level. If a large release of vapour occurs, the vapour may displace the oxygen available for breathing, resulting in suffocation. Although smaller leaks pose no acute health hazards, exposure to levels of more than 1,000 parts per million (the same limit as R-22) can be harmful. Symptoms of exposure to dangerous levels of R-410A include dizziness, headache, confusion, cardiac irregularities, and loss of consciousness in extreme cases. If a leak is present or suspected, a suitable leak detector should be used to determine the need for ventilation or respiratory protection.

R-410A expands significantly when heated. Exposure of a container to direct sunlight or other heat source can cause it to burst, resulting in serious injury. Allied Signal recommends that its cylinders not be allowed to exceed 52°C. Care also should be taken to avoid damage to containers that could cause them to leak or rupture. Storage near corrosive chemicals or fumes or on damp floors should be avoided.

Although R-410A is not flammable, it may become combustible at elevated pressures in the presence of large quantities of air. Containers and recovery/recycling equipment should not be exposed to welding, brazing, open flames, or high temperatures until thoroughly purged of all traces of liquid and vapour. Recovery and recycling systems with self-purging capabilities are invaluable for this purpose.

Other common sense precautions for storing and handling R-410A include:

- using personal protective equipment (e.g., side shield glasses and safety shoes) when handling containers
- avoiding skin contact, which may cause frostbite
- protecting containers from damage, and hoses from cuts or abrasions
- storing containers under a roof to protect them from weather extremes
- never attempting to repair or alter containers or valves.

As stated previously, the energy efficiency of R-410A is allowing the design of smaller, more efficient air conditioning equipment. By following the procedures and noting the precautions provided in this article, the technician can readily service systems using this increasingly popular refrigerant.

The following is a quick review of some of the most important points to remember when you are working with R-410A:

- Never vent R-410A (or any other refrigerant) to the atmosphere.
- Use good piping practices when installing units with R-410A. (Piping practices are similar to those recommended for R-22 systems.)
- R-410A operates at pressures 50 to 70% higher than those of R-22. Be certain that servicing equipment and replacement components are designed to operate with this refrigerant.
- R-410A cylinders are rose coloured (PMS 507).
- Recovery cylinders must be rated at 27 bar or higher
- Charge systems with liquid refrigerant to avoid fractionation.
- Manifold sets should be at 52 bar (high side) and 14 bar (low side), with a 35 bar low-side retard.
- Use hoses with a 52 bar service pressure rating.
- R-410A is compatible with POE oils. POE oils absorb moisture rapidly. Do not expose the oil to the atmosphere. Keep all components sealed until the time of installation/brazing.

9.3 R410a Charging Instruction

- R410a should be charged only at liquid phase into the air conditioner.
- Never to charge 410a with vapour state during the charging process.
- The refrigerant tank should be placed upside down every time.
- The original charging hose should be used for R410a. Because the hose type is different than R22.
- R22 hoses can not fix the service valve on the unit.
-

There are two options which we can charge the R410a into the system::

1. No Refrigerant Leakage on the System

This option can be required when the compressor, condenser, 4 way valve, etc. are changed in the system.

The authorized technician can apply this process only.

The vacuum operation should be applied to the unit first at least 1 hour after the replacing any parts which it is specified above.

The charging process can be start if there is no any leakage on the system. The authorized technician should be checked the vacuum quality on the manifold gauge.

The gauge should be displayed -760 mmHG or -1 Bar Gauge if there is no any leakage after the vacuum pump is stopped. Otherwise the pressure will increase if there is any leakage on the system after the vacuum pump is stopped.

The leakage point should be found and repaired if there is any leakage.

The charging process should be proceed only with a calibrated electronic scale.

The refrigerant tank should be placed on the scale after the manifold and refrigerant hose fixed to the unit's service valve. The tank should be placed always upside down.

⚠ Always a little bit refrigerant should be set free to the ambient to prevent the air inside the hole in to the unit.

It is best and certain way to charge the R410a by using the required amount according to the unit's name plate. Please check the unit's name plate always to see the correct amount.

⚠ The additional amount should be added if the piping length is longer than 4 meters according to unit's specs. Please check the required additional refrigerant amount for every unit on its spec sheet.

The required amount should be charged according to amount by using electronic scale. Only the liquid phase of refrigerant should be charged.

⚠ The compressor shouldn't be run during the charging process.

The charging process should be finished after the required amount is charged in to the system and remove the manifold and refrigerant hose.

2. Refrigerant Leakage on the System

First of all the leakage point should be repaired on the system.

For example that there is a leakage on the service valve at piping connection.

The piping connection point should be repaired and all the process above should be repeated for charging the refrigerant.

- Vacuum first.
- Vacuum quality and reliability check.
- Refrigerant charge.



The photos above left to right;

The refrigerant tank should be placed upside down on the electronic scale.

The quality manifold and hoses should be used.

The vacuum process always should be applied.

The R410a compressors uses POE oil inside and POE oil is high sensitive about humidity.

Vacuum process is most important stage before the charging process.

9.4 R410A Pressure Temperature Chart

| R410A Temperature (°C) | Liquid | | | Vapour | | |
|------------------------------|--------------------|--------------------|-----------------|--------------------|--------------------|--------------------|
| | Pressure (barA) | Pressure (barg) | Pressure (psig) | Pressure (barA) | Pressure (barg) | Pressure (psig) |
| 70 | 0,36 | -0,66 | -9,52 | 0,35 | -0,66 | -9,55 |
| -68 | 0,40 | -0,61 | -8,85 | 0,40 | -0,61 | -8,87 |
| -66 | 0,45 | -0,56 | -8,10 | 0,45 | -0,56 | -8,13 |
| -64 | 0,51 | -0,50 | -7,27 | 0,51 | -0,50 | -7,31 |
| -62 | 0,57 | -0,44 | -6,37 | 0,57 | -0,44 | -6,40 |
| -60 | 0,64 | -0,37 | -5,37 | 0,64 | -0,37 | -5,41 |
| -58 | 0,72 | -0,30 | -4,29 | 0,71 | -0,30 | -4,33 |
| -56 | 0,80 | -0,21 | -3,10 | 0,80 | -0,22 | -3,15 |
| -54 | 0,89 | -0,12 | -1,81 | 0,88 | -0,13 | -1,86 |
| -52 | 0,98 | -0,03 | -0,41 | 0,98 | -0,03 | -0,47 |
| -50 | 1,09 | 0,08 | 1,11 | 1,09 | 0,07 | 1,05 |
| -48 | 1,20 | 0,19 | 2,76 | 1,20 | 0,19 | 2,69 |
| -46 | 1,33 | 0,31 | 4,54 | 1,32 | 0,31 | 4,47 |
| -44 | 1,46 | 0,45 | 6,46 | 1,45 | 0,44 | 6,38 |
| -42 | 1,60 | 0,59 | 8,53 | 1,60 | 0,58 | 8,45 |
| -40 | 1,76 | 0,74 | 10,76 | 1,75 | 0,74 | 10,66 |
| -38 | 1,92 | 0,91 | 13,15 | 1,91 | 0,90 | 13,05 |
| -36 | 2,10 | 1,08 | 15,71 | 2,09 | 1,08 | 15,60 |
| -34 | 2,29 | 1,27 | 18,45 | 2,28 | 1,26 | 18,33 |

| | | | | | | |
|-----|-------|-------|--------|-------|-------|--------|
| -32 | 2,49 | 1,47 | 21,38 | 2,48 | 1,47 | 21,25 |
| -30 | 2,70 | 1,69 | 24,51 | 2,69 | 1,68 | 24,37 |
| -28 | 2,93 | 1,92 | 27,84 | 2,92 | 1,91 | 27,69 |
| -26 | 3,18 | 2,16 | 31,38 | 3,17 | 2,15 | 31,22 |
| -24 | 3,44 | 2,42 | 35,16 | 3,43 | 2,41 | 34,98 |
| -22 | 3,71 | 2,70 | 39,16 | 3,70 | 2,69 | 38,98 |
| -20 | 4,01 | 2,99 | 43,41 | 3,99 | 2,98 | 43,21 |
| -18 | 4,32 | 3,30 | 47,91 | 4,30 | 3,29 | 47,69 |
| -16 | 4,65 | 3,63 | 52,67 | 4,63 | 3,62 | 52,44 |
| -14 | 4,99 | 3,98 | 57,70 | 4,98 | 3,96 | 57,46 |
| -12 | 5,36 | 4,35 | 63,02 | 5,34 | 4,33 | 62,76 |
| -10 | 5,75 | 4,73 | 68,63 | 5,73 | 4,71 | 68,35 |
| -8 | 6,15 | 5,14 | 74,54 | 6,13 | 5,12 | 74,24 |
| -6 | 6,58 | 5,57 | 80,76 | 6,56 | 5,55 | 80,44 |
| -4 | 7,03 | 6,02 | 87,31 | 7,01 | 6,00 | 86,97 |
| -2 | 7,51 | 6,50 | 94,19 | 7,48 | 6,47 | 93,83 |
| 0 | 8,01 | 6,99 | 101,41 | 7,98 | 6,97 | 101,03 |
| 2 | 8,53 | 7,52 | 109,00 | 8,50 | 7,49 | 108,59 |
| 4 | 9,08 | 8,07 | 116,95 | 9,05 | 8,04 | 116,51 |
| 6 | 9,65 | 8,64 | 125,28 | 9,62 | 8,61 | 124,82 |
| 8 | 10,25 | 9,24 | 133,99 | 10,22 | 9,21 | 133,52 |
| 10 | 10,88 | 9,87 | 143,13 | 10,85 | 9,84 | 142,61 |
| 12 | 11,54 | 10,53 | 152,66 | 11,50 | 10,49 | 152,12 |
| 14 | 12,23 | 11,22 | 162,63 | 12,19 | 11,18 | 162,05 |
| 16 | 12,95 | 11,93 | 173,03 | 12,91 | 11,89 | 172,43 |
| 18 | 13,70 | 12,68 | 183,89 | 13,65 | 12,64 | 183,25 |
| 20 | 14,48 | 13,46 | 195,21 | 14,43 | 13,42 | 194,55 |
| 22 | 15,29 | 14,28 | 207,02 | 15,24 | 14,23 | 206,31 |
| 24 | 16,14 | 15,13 | 219,31 | 16,09 | 15,07 | 218,57 |
| 26 | 17,02 | 16,01 | 232,10 | 16,97 | 15,95 | 231,33 |
| 28 | 17,94 | 16,93 | 245,41 | 17,88 | 16,87 | 244,62 |
| 30 | 18,89 | 17,88 | 259,26 | 18,84 | 17,82 | 258,42 |
| 32 | 19,89 | 18,87 | 273,66 | 19,83 | 18,81 | 272,79 |
| 34 | 20,92 | 19,91 | 288,62 | 20,86 | 19,84 | 287,71 |
| 36 | 21,99 | 20,98 | 304,15 | 21,92 | 20,91 | 303,21 |
| 38 | 23,10 | 22,09 | 320,29 | 23,04 | 22,02 | 319,32 |
| 40 | 24,26 | 23,24 | 337,02 | 24,19 | 23,17 | 336,02 |
| 42 | 25,45 | 24,44 | 354,39 | 25,38 | 24,37 | 353,37 |
| 44 | 26,70 | 25,68 | 372,42 | 26,62 | 25,61 | 371,36 |
| 46 | 27,99 | 26,97 | 391,09 | 27,91 | 26,90 | 390,02 |
| 48 | 29,32 | 28,31 | 410,47 | 29,25 | 28,23 | 409,36 |
| 50 | 30,71 | 29,69 | 430,55 | 30,63 | 29,62 | 429,42 |
| 52 | 32,14 | 31,13 | 451,34 | 32,06 | 31,05 | 450,21 |
| 54 | 33,63 | 32,61 | 472,90 | 33,55 | 32,54 | 471,77 |
| 56 | 35,17 | 34,16 | 495,25 | 35,09 | 34,08 | 494,12 |
| 58 | 36,76 | 35,75 | 518,39 | 36,69 | 35,67 | 517,27 |
| 60 | 38,42 | 37,41 | 542,37 | 38,34 | 37,33 | 541,30 |
| 62 | 40,13 | 39,12 | 567,24 | 40,06 | 39,05 | 566,20 |
| 64 | 41,91 | 40,90 | 593,02 | 41,84 | 40,83 | 592,04 |
| 66 | 43,75 | 42,74 | 619,74 | 43,69 | 42,68 | 618,86 |
| 68 | 45,67 | 44,66 | 647,50 | 45,62 | 44,60 | 646,74 |
| 70 | 47,65 | 46,64 | 676,28 | 47,62 | 46,60 | 675,76 |

9.5 Vacuuming and Refrigerant Charging & Discharging Process

Vacuuming of the system is very important in terms of performance in cooling systems. During the installation process or if the system is switched on, it must be vacuumed. Air and moisture in the refrigeration system have undesirable effects as indicated below:

- Pressure in the system rises.
- Operating current rises.
- Cooling or heating (only for models with heating function) efficiency drops.
- Moisture in the refrigerant circuit may freeze and block capillary tubing.
- Water may lead to corrosion of parts in the refrigeration system.

Therefore, pipe installation between the indoor and outdoor unit must apply leakage test and be evacuated to remove any non condensables and moisture from the system.

Vacuum operation should be done with a high quality vacuum pump.

Check that each tube (both liquid and gas side tubes) between the indoor and outdoor units have been properly connected and all wiring for the test run has been completed. Remove the service valve caps from both the gas and the liquid side on the outdoor unit.

Note that both the liquid and the gas side service valves on the outdoor unit are kept closed at this stage.

1. When relocating the unit to another place, perform evacuation using vacuum pump.
2. Make sure the refrigerant added into the air conditioner is in liquid form in any case.
3. Oil trap should be installed every 5m (no oil trap needed when outdoor unit installed at a lower place than indoor unit).

Vacuuming Application

1. For cooling (summer), the low pressure line (blue hose) is connected to the 3-way (turn) valve of the outdoor unit. Tighten the flare nut.
2. For heating (winter) the high pressure line (red hose) is connected to the 3-way (turn) valve of the outdoor unit. Tighten the flare nut.
3. Open the valve of the low pressure side of manifold gauge counter-clockwise
4. The vacuum pump is switched on. System start vacuuming by opening manifold low pressure line valve and system valve.
5. Vacuuming continue for 10 minutes until the precise vacuum clock falling to zero (0).
6. Close the valve of the low pressure side of manifold gauge clock side. Then vacuum pump is switched off.
7. Remove the hose of the low pressure side of manifold gauge.
8. After the vacuum process is completed, a precise vacuum manometer is observed for 5 minutes.
9. Make sure the pressure display in the pressure indicator is a little higher than the atmospheric pressure. This procedure verifies if the refrigerant goes through the tubes correctly.
10. The rise of the pointer on the vacuum clock indicates leakage in the system. In this case, it is necessary to check the system for leakage.
11. Check for gas leakage.
12. At this time, especially check for gas leakage from the 3-way valve's stem nuts, and from the service port cap.
13. If there is no leakage, the valve on the 2-way (pressure) valve on the unit is opened with the allen wrench and the refrigerant in the outdoor unit is supplied to the system.
14. The return valve is opened and the system is made ready for operation.

Pump Down

When relocating or disposing of the air conditioner, pump down the system following the procedure below so that no refrigerant is released into the atmosphere.

- Connect the hose of manifold valve to the charge port of stop valve on the gas pipe side of the outdoor unit.
- Close the stop valve on the gas pipe side almost completely.
- Fully close the stop valve on the liquid pipe side.
- Turn on the unit in COOL mode.
- Fully close the stop valve on the gas pipe side when the pressure gauge shows 1 - 0.5 kgf/cm² (100 ~ 50 kPa)
- Stop the test run operation by turn the unit off and all the refrigerant gas have been collected in the outdoor unit.

Refrigerant Refill

⚠ For the R410A refrigerant, can not be added into the system before it is completely discharged from system.

- Purge air. (for new installation only)
- Turn the 3-way valve clockwise to close, connect the pressure gauge (low pressure side) to the service valve, and open the 3-way valve again.
- Connect the tank to refill with Refrigerant.
- Set the unit to cool operation mode.

- Check the pressure indicated by the pressure gauge. (low pressure side)
- Standard pressure should be 7.5-10.5 kg/cm² in a regular, high operation mode.
- Open the refrigerant tank and fill with refrigerant until the rated pressure is reached.
- It is recommended not to pour the refrigerant in too quickly, but gradually while operating a pressure valve
- Stop operating of the air conditioner
- Close the 3-way valve, disconnect the pressure gauge, and open the 3-way valve again.
- Close the cap of each valve.

Gas Leakage Check

1. Soap water method

Apply a soap water or a liquid neutral detergent on the indoor unit connection or outdoor unit connections (A: Low side valve, B: High side valve C and D are ends of indoor unit connection) by a soft brush to check for leakage of the connecting points of the piping. If bubbles come out, the pipes have leakage point.

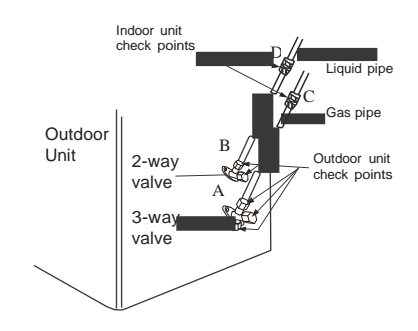

2. Leak detector

Use the leak detector to check for leakage.

10. CLEANING AND MAINTENANCE

10.1 Before Maintenance

Turn the system off before cleaning. To clean, wipe with a soft, dry cloth. Do not use bleach or abrasives.

- Power supply must be disconnected before cleaning the indoor unit.
- A cloth dampened with cold water may be used on the indoor unit if it is very dirty. Then wipe it with a dry cloth.
- Do not use a chemically treated cloth or duster to clean the unit.
- Do not use benzine, thinner, polishing powder, or similar solvents for cleaning. These may cause the plastic surface to crack or deform.
- Never use water hotter than 40°C to clean the front panel, it could cause deformation and discolouration.

10.2 Cleaning the Unit

Wipe the unit with a soft dry cloth only. If the unit is very dirty, wipe it with a cloth soaked in warm water.

10.3 Cleaning the Filters

A clogged air filter reduces the cooling efficiency of this unit. Please clean the filter once every month.

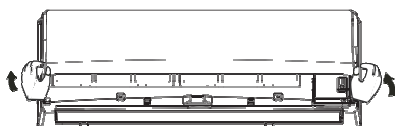

1. Lift the indoor unit front panel up to an angle until it stops with a full support from the bracket.

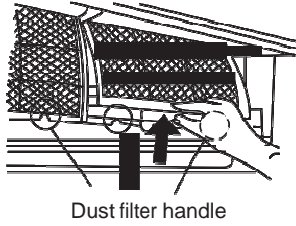

2. Hold the dust filter handle and lift it up slightly to take it out from the filter holder.

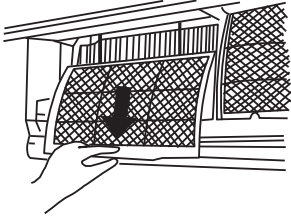

3. Then pull the dust filter downwards out of the indoor unit. Vacuum the dust filters with a vacuum cleaner. If the filters are too dirty, wash them with warm water and mild detergent. Make sure to dry the filters before re-install them. Do not dry with fire or under direct sunlight.

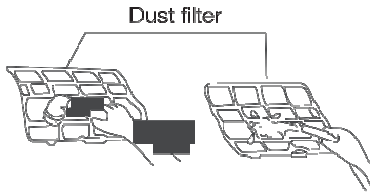

4. Insert the upper portion of air filter back into the unit, taking care that the left and right edges line up correctly and place filter into position.

10.4 Cleaning the air outlet and the panel

1. Use a dry and soft cloth to wipe it.
2. Pure water or mild detergent may be used if it is very dirty.
 - Do not use benzene, thinner, polishing powder, or similar solvents for cleaning. These may cause the surface to crack or deform.
 - To avoid the risk of electrical shock or fire, do not let water fall into the indoor unit.
 - Never wipe the air flow louver violently.
 - Do not operate your air conditioner without filter. If your filters are unusable, buy new ones from the authorised service.

10.5 Preparation for extended non operation

If you plan to idle the unit for a long time, perform the following:

1. Clean the indoor unit and filters.
2. Operate the fan for about 15 minutes to dry the inside of the unit.
3. Stop the air conditioner and disconnect power.
4. Remove the batteries from the remote controller. The outdoor unit requires periodic maintenance and cleaning. Do not attempt to do this yourself. Contact your dealer or service provider.

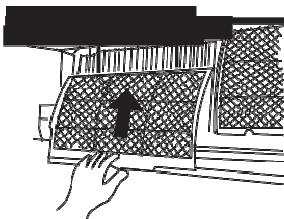

11. TROUBLESHOOTING

| No | Malfunction Name | Error Code | Possible Causes | Troubleshooting |
|----|--|------------|---|---|
| 1 | Abnormal condition of the room sensor | E2 | Indoor ambient temperature sensor socket may have been came loose or poor contacted with controller. | Check the sensor socket and cable whether loose contact or not. |
| | | | There may have been a short circuit or open circuit on sensor. | Check the resistance value of the sensor via referring to the resistance table. Replace the sensor if it is short or open circuit. |
| | | | Main board (controller) is may have been broken. | Replace the controller. |
| 2 | Abnormal condition of the indoor heat exchanger sensor | E3 | Indoor unit pipe sensor may have been removed from its housing on the evaporator. | Check the housing and reset the sensor properly. |
| | | | There may have been a short circuit or open circuit on sensor. | Check the resistance value of the sensor via referring to the resistance table. Replace the sensor if it is short or open circuit. |
| | | | Main board (controller) is may have been broken. | Replace the controller. |
| 3 | Indoor unit fan motor lock | E4 | Fan motor cable may have been came loose on its sockets on controller or dislocated from its place | Check the socket and cable connections on the indoor pcb whether it is connected or not. If there is any impropriety in connections, fix it properly |
| | | | Cross fan may have not been rotate because of a mechanical block. | <ul style="list-style-type: none"> Slowly stir the cross fan manually or with an appropriate tool when the unit is de energized. If the cross fan do not rotate smoothly, check the points that can cause the mechanical jam (etc. cross fan rubber, fan bearing, motor). Reinstall the motor and cross fan to make it rotate smoothly. |
| | | | Motor or controller is damaged. | <ul style="list-style-type: none"> Check the motor's power supply from the indoor unit. The power supply should be checked between 280-310 VDC. Replace the PCB, if the power supply does not exist. Replace the motor, if the power supply is exist. |
| 4 | Gas leak protection | e5 | There may have been an obstruction in capillary. | Connect the manifold to the outdoor unit service valve to measure the R410A pressure of the product and run the product in cooling mode. If the pressure below 0 (-) bar, capillary group are blocked. Replace the capillary group. Perform vacuuming, charge refrigerant at the label value. |
| | | | <ul style="list-style-type: none"> There may have been a refrigerant leakage in the system. There may have lack of refrigerant. | Measure the R410A pressure during working on cool operation mode. Then compare the gas pressure according to standard operating pressure table located "operation data section". If the gas pressure lower than standard pressure or there is no refrigerant in the system, firstly, check for leakage into all cooling system. Find and repair the leakage point. If the recovery is not possible, you should change the malfunctioned component. After this process, you have to perform vacuuming, then discharge all the refrigerant and recharge again in the amount of label value. |
| | | | There may have an obstruction in evaporator. | If the E5 problem is not solved during the 3th step, in order to check that there may have an obstruction whether or not in evaporator, cover the surface of the evaporator to expose the pipes and then run the AC on cooling mode. If there is a non-frosting section on evaporator pipes, it means there is an obstruction in evaporator. Replace the evaporator. After this process, you have to perform vacuuming, then discharge all the refrigerant and recharge again in the amount of label value |
| | | | There may have been a malfunction on room or evaporator sensor. | Check the sensor socket and cable whether loose contact or not. Check the resistance value of the sensor via referring to the resistance table. Replace the sensor if it is short or open circuit. |

| No | Malfunction Name | Error Code | Possible Causes | Troubleshooting |
|----|---|------------|---|---|
| 5 | Low voltage protection | E6 | Supply voltage is higher or lower than AC operating voltage specification | <p>Check the supply voltage. If voltage is higher or lower than the operating interval, the AC can not work. When the supply voltage reaches the operating interval, the AC is go on working.</p> <p>Compressor running state;</p> <ul style="list-style-type: none"> - Power supply \leq 160 VAC for 60 sec continuously and stop. - Power supply \geq 165 VAC for 60 sec continuously and reset the fault. - Power supply \geq 275 VAC for 60 sec continuously and stop. - Power supply \leq 260 VAC for 60 sec continuously and reset the fault. |
| 6 | Model option Error / E ² error | e7 | When the microcomputer is lost the written E ² data inside. | <p>This error means "there is a model option setting error in the air conditioner"</p> <p>The required data should be re-flashed by the remote control in to the unit following the "Model Option Setting" instruction by using the required model HEX data in the following table.</p> |

NOTE: The leading zero number does not change

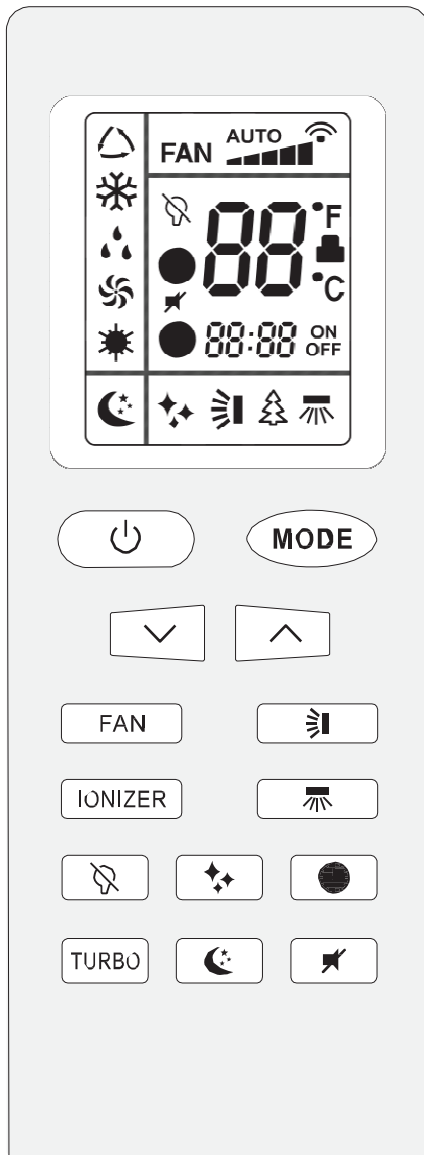

OPTION SET MODE

You must follow the steps below to put your remote in setting mode;

1. The batteries should be removed.
2. You must press simultaneously set (+) and set (-) buttons when re-inserting the batteries.
3. When you reinsert the batteries, the remote controller will switch to set mode. (When the RC switch in this mode, you can not control the RC standard use mode.)
4. You will see 6 zero icon on the screen.
5. Start entering the setting codes by pressing the buttons shown in the tables.

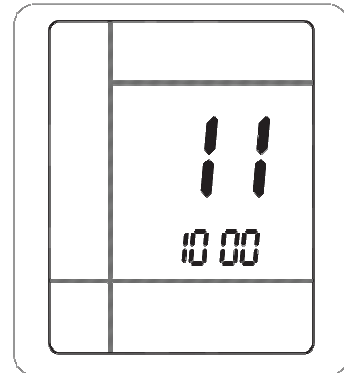
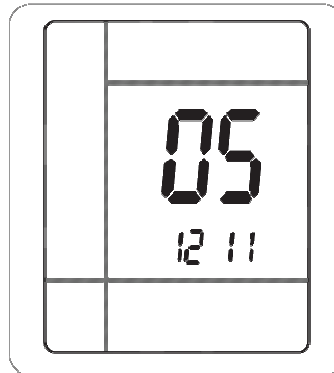

| | | | | | |
|---|-----|-----|-------|---------|-----|
| 1 | 2 ^ | 3 v | 4 FAN | 5 TURBO | 6 ☾ |
| 0 | 5 | 1 | 2 | 1 | 1 |

| | | | | | |
|---|-----|-----|-------|---------|-----|
| 1 | 2 ^ | 3 v | 4 FAN | 5 TURBO | 6 ☾ |
| 1 | 1 | 1 | 0 | 0 | 0 |

NOTE: The leading zero number does not change

OPTION SET CODE

Heat Pump

05 18 10 - 11 10 00

Cooling Only

05 18 11 - 11 10 00

(Press the mode button to move to the second page)

12. DISASSEMBLY AND REASSEMBLY INSTRUCTIONS

12.1 Indoor Unit

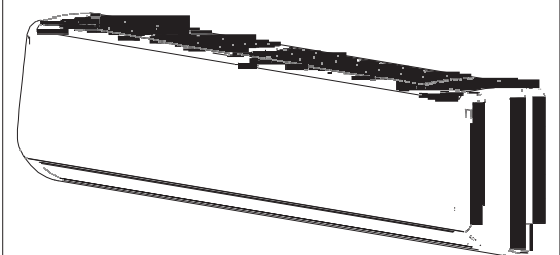
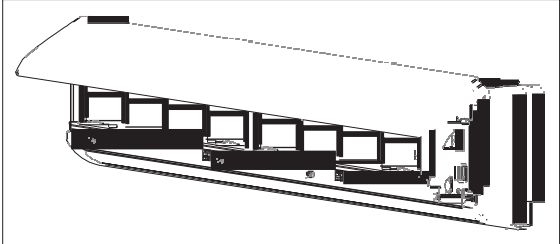
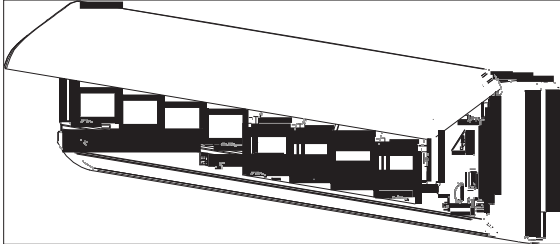
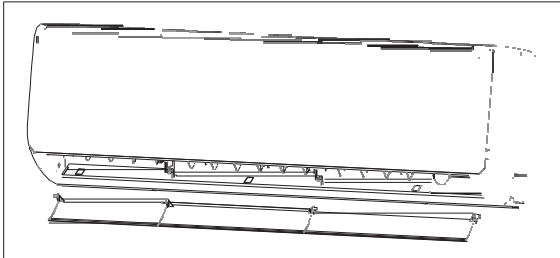
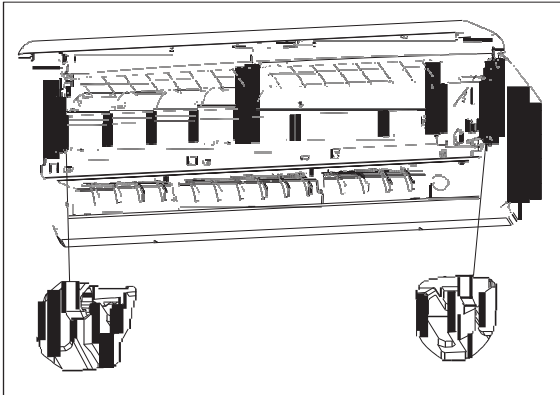
| Steps | Procedure |
|--|---|
| <p>Visual before disassembly</p> |  |
| <p>Removal of filter and horizontal louver</p> <p>Open the front panel.</p> <p>Push the filter inward and then draw it upward to remove it.</p> <p>Remove the center pin of horizontal louver from its slot.</p> <p>Remove the horizontal louver pin that connected with step motor shaft by pulling the left side.</p> <p>Finally, remove the horizontal louver from on the far left.</p> |    |
| <p>Removal of front panel and front case</p> <p>Push up on the front cover by holding the taps on both sides of indoor unit.</p> |  |

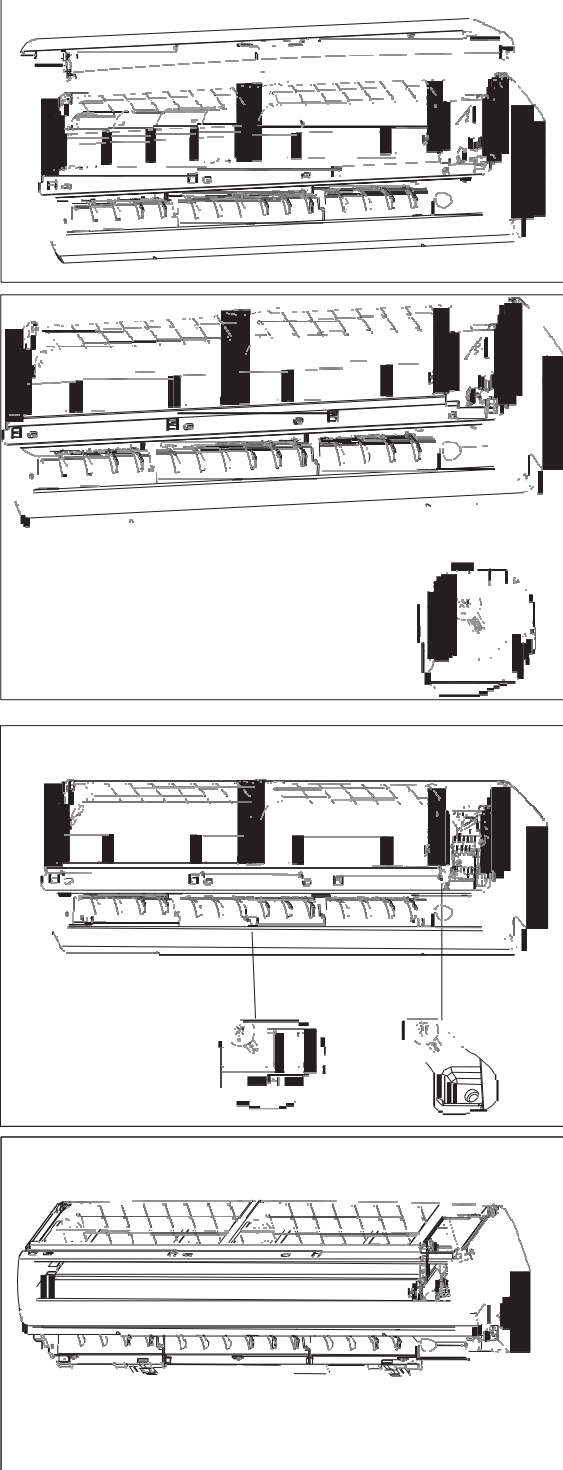
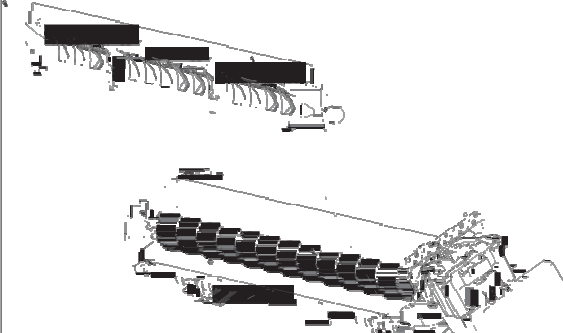
| Steps | Procedure |
|--|--|
| <p>If you want to disjoint the front panel, remove the panel by waggling toward left and right the two tabs located on the backside from their slots.</p> <p>Screw off the electric box cover located under the front panel.</p> <p>Remove the display cable socket located on the indoor unit electronic card.</p> <p>There are 7 pcs of screws on the front case. Screw off all of them.</p> <p>After screw off all the screws, remove the front case starting with the right side by holding and pulling it up.</p> |  |
| <p>Removal of drain tray</p> <p>Remove the ionizer cable from the ionizer housing. Then remove the step motor cable socket on the controller properly.</p> <p>Screw off the three screws that connect the rear body and drain tray.</p> |  |

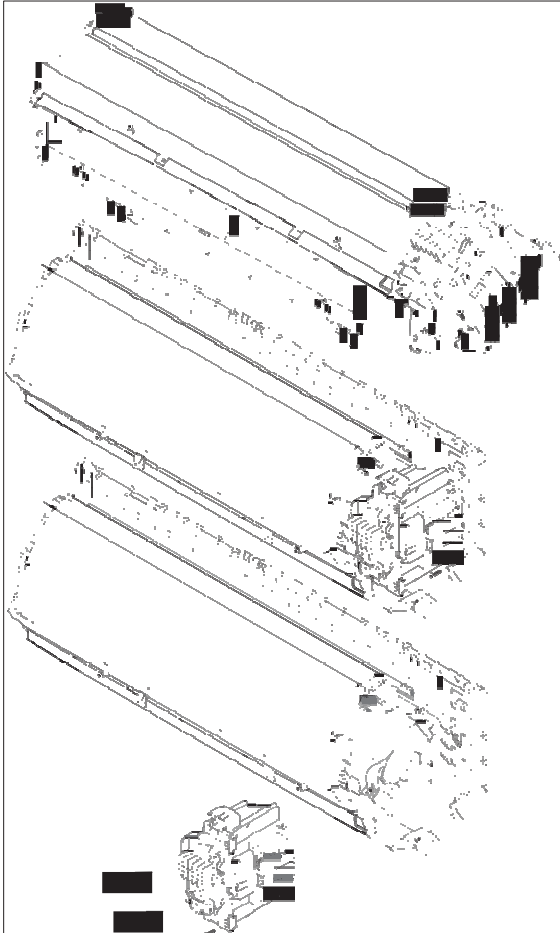
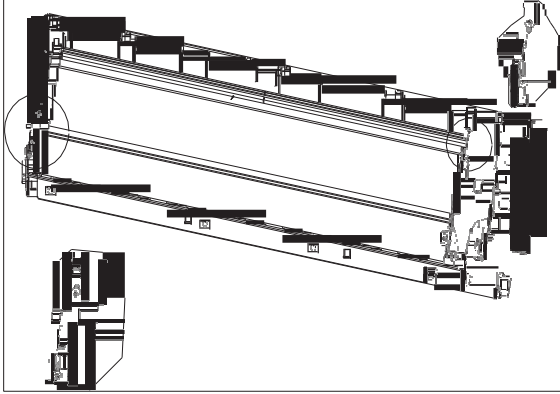
| Steps | Procedure |
|--|--|
| <p>Removal of electric box assy</p> <p>Firstly, remove the front case properly. Then screw off the electric box cover.</p> <p>Remove the pipe sensor and ambient sensor located on evaporator from their housing and screw off the earthing cable.</p> <p>Control panel (electric) box is fixed to the indoor unit with four screws. Remove this screws with a proper tool. Push towards the rear and let the box get rid of the rear body connecting tab.</p> |  |
| <p>Removal of evaporator</p> <p>Evaporator is fixed to the body with three screws and two pawls.</p> <p>Remove the two screws located on evaporator plastic on left side the product and other screw located on right rear side</p> <p>Remove the two pawls located on left rear side and right front side</p> |  |

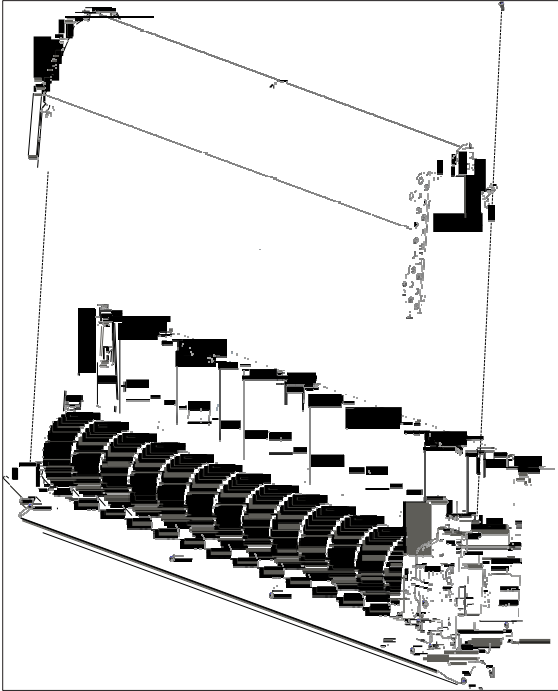
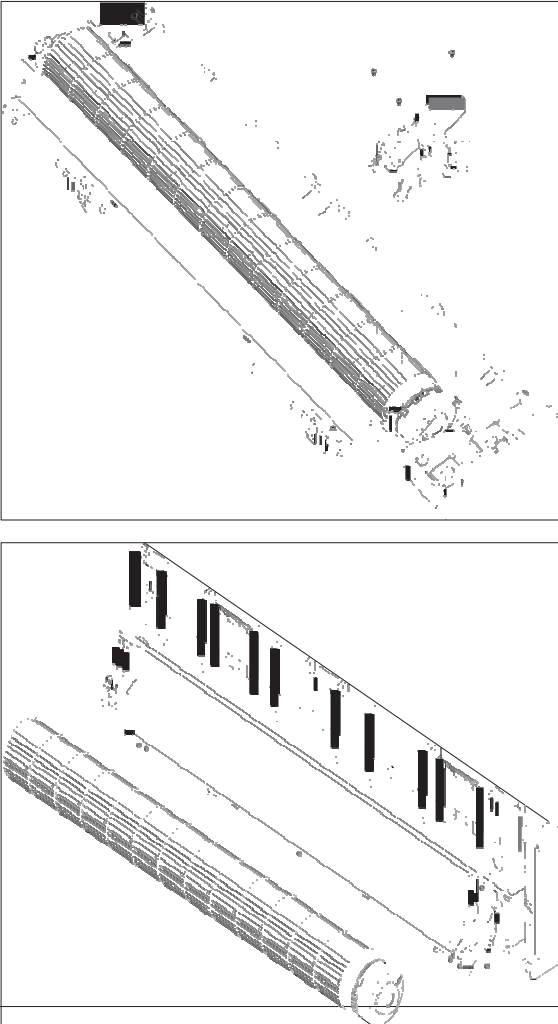
| Steps | Procedure |
|---|---|
| <p>Move the evaporator pipes towards the right side. Then, you can remove the evaporator by raising.</p> |  |
| <p>Removal of fan motor and cross fan</p> <p>Fan motor cover is fixed to the rear body with three screws. Screw off these screws with proper tool and remove the cover by raising.</p> <p>Remove cross flow fan by screwing off the connection screw that connecting with motor shaft and cross flow fan.</p> |  |

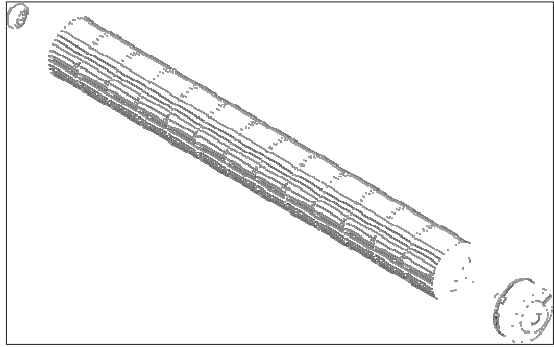
| Steps | Procedure |
|---|--|
| Remove the ring of bearing of sub-assy on the cross flow fan. |  |

12.2 Outdoor Unit

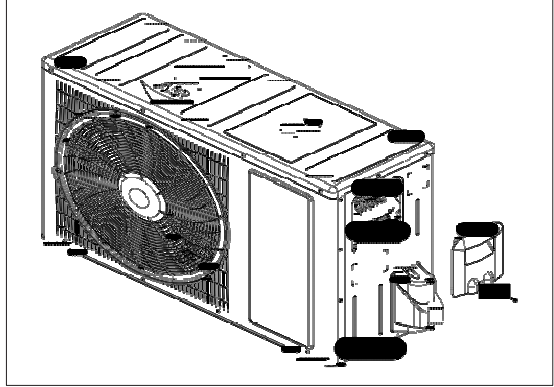
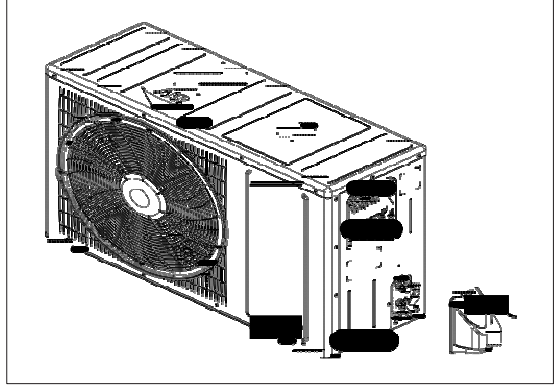
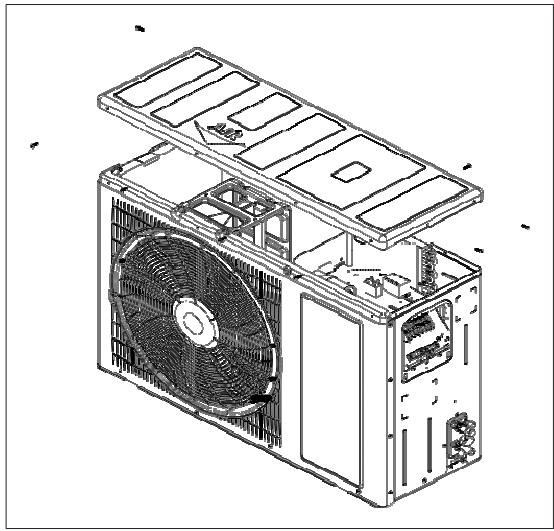
| Steps | Procedure |
|---|--|
| Screw off the one screw located in electric box cover. |  |
| In order to reach the valves, you should screw off the one screw located on valve cover and remove the cover. |  |
| You should screw off the eight screws located on the top panel in order to remove the top panel. |  |

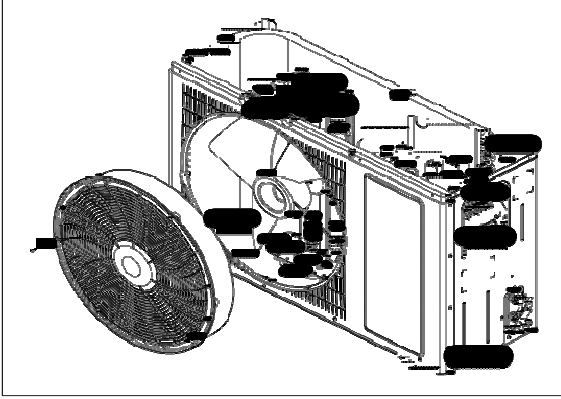
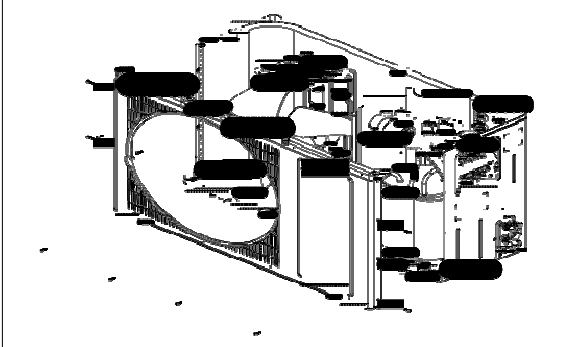
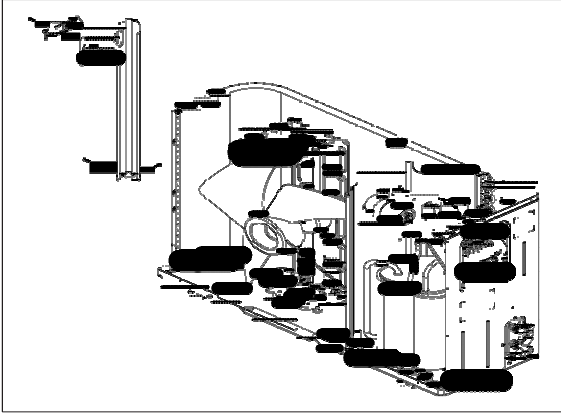
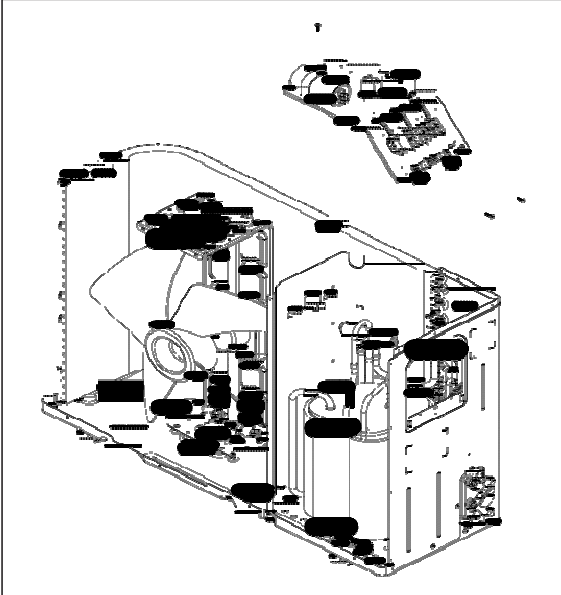
| Steps | Procedure |
|---|--|
| <p>You can reach the fan propeller, outdoor fan motor and motor support by removing the grill without removing the front panel completely.</p> |  |
| <p>You should screw off the three screws located on the upper, four screws located on the bottom, four screws in left side and two screws in the right side on the front panel in order to remove the front panel and reach the compressor and 4 way valve.</p> |  |
| <p>Screw off the two screws on the electrical connection terminal.</p> |  |
| <p>Finally, screw off the one screw on the capacitor and remove the capacitor.</p> |  |

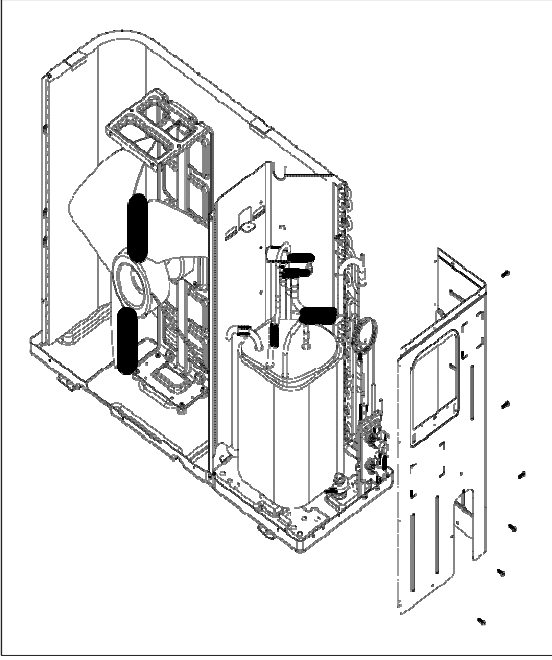
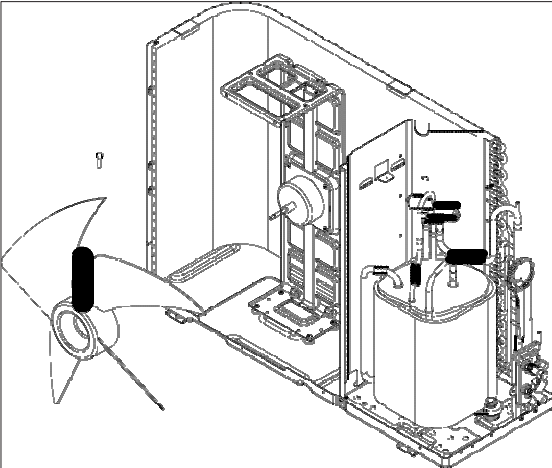
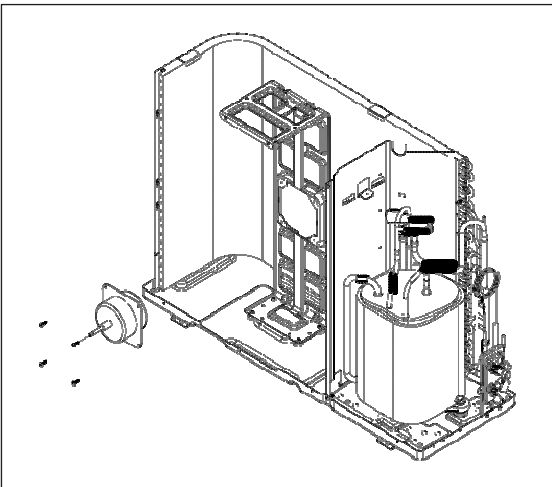
| Steps | Procedure |
|---|--|
| <p>Remove six screws connecting the right side plate with the chassis, the valve support and the electric box. Remove the right side plate.</p> |  |
| <p>Loosen the screw fixing the blade. Remove the axial flow blade.</p> |  |
| <p>Loosen the 4 tapping screws fixing the motor. Disconnect the leading wire of motor. Remove the motor.</p> |  |

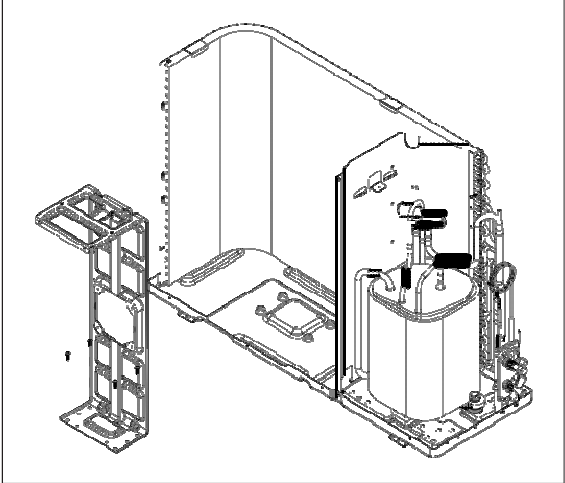
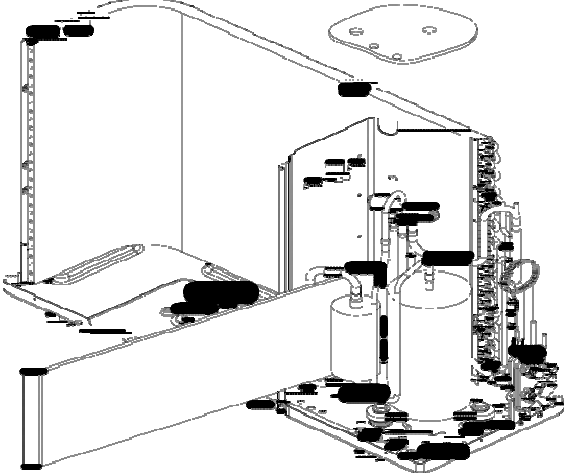
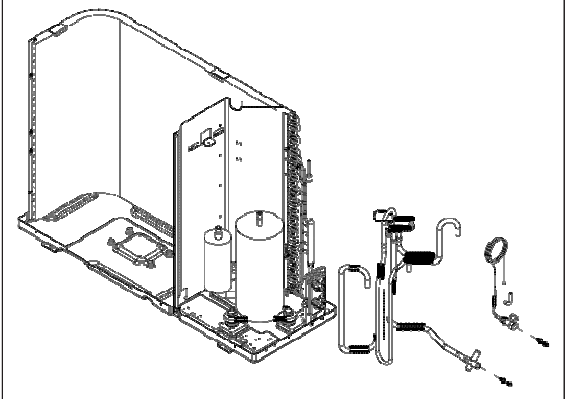
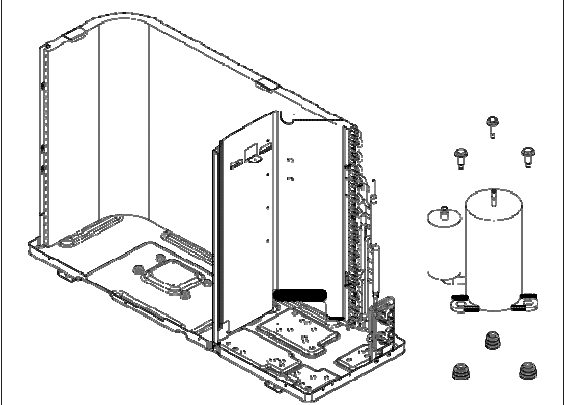
| Steps | Procedure |
|--|--|
| <p>Loosen the one tapping screw fixing the motor support. Raise the support to remove it.</p> |  |
| <p>Remove the upper and wrapped soundproof sponge by taking out on the touch and close fastener.</p> |  |
| <p>Unsolder the capillary, valves and the outlet pipe of condenser. Do not block the capillary with welding slag during unsoldering.</p> <p>Remove the 2 screws fixing the gas valve. Unsolder the gas valve and the air-return pipe.</p> <p>(NOTE: Discharge the refrigerant completely before unsoldering; when unsoldering, wrap the gas valve with wet cloth to avoid damage to the valve caused by high temperature).</p> <p>Remove the 2 screws fixing the liquid valve and unsolder the liquid valve and the Y-type pipe to remove the liquid valve.</p> <p>Solder of the pipe connecting the compressor, condenser and valve support. (Do not block the capillary during soldering.)</p> |  |
| <p>Loosen the 3 ground bolts of the compressor. Remove the compressor</p> |  |

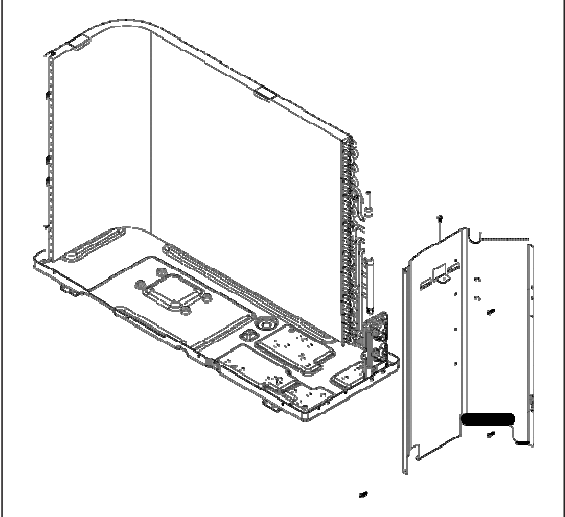
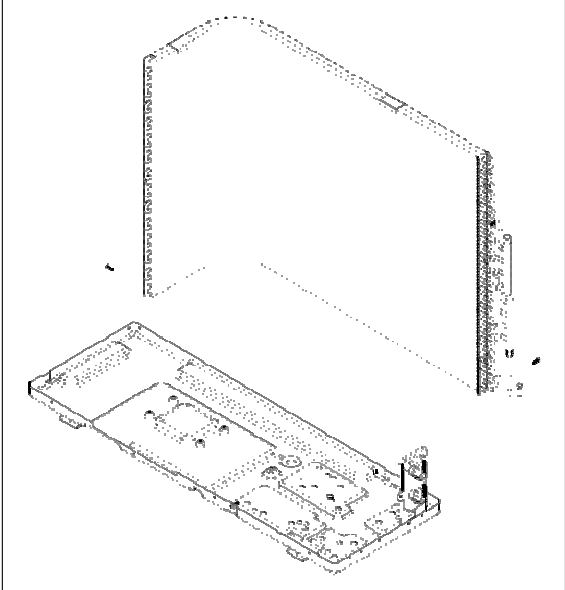
| Steps | Procedure |
|---|---|
| <p>Remove the 4 screws fixing the isolation sheet and then remove the isolation sheet</p> |  <p>The diagram shows a perspective view of a rectangular unit. A large, flat isolation sheet is being lifted away from the top and back of the unit. The sheet is held in place by four screws, one at each corner. The unit's internal components, including a condenser and various pipes, are visible on the base.</p> |
| <p>Recover the refrigerant at first. Loosen fixing screw on condenser connection. Disassemble the pipes in both inlet and outlet with welding torch. Detach the condenser. After remove all condenser connection screws, pull the condenser upwards to remove it.</p> |  <p>The diagram shows the unit with the condenser being pulled upwards and away from the base. The condenser is a long, rectangular component with a series of vertical fins. The base of the unit shows the internal piping and the condenser's connection points. The condenser is shown in a dashed-line perspective, indicating its movement away from the unit.</p> |

13. EXPLODED VIEW INDOOR UNIT

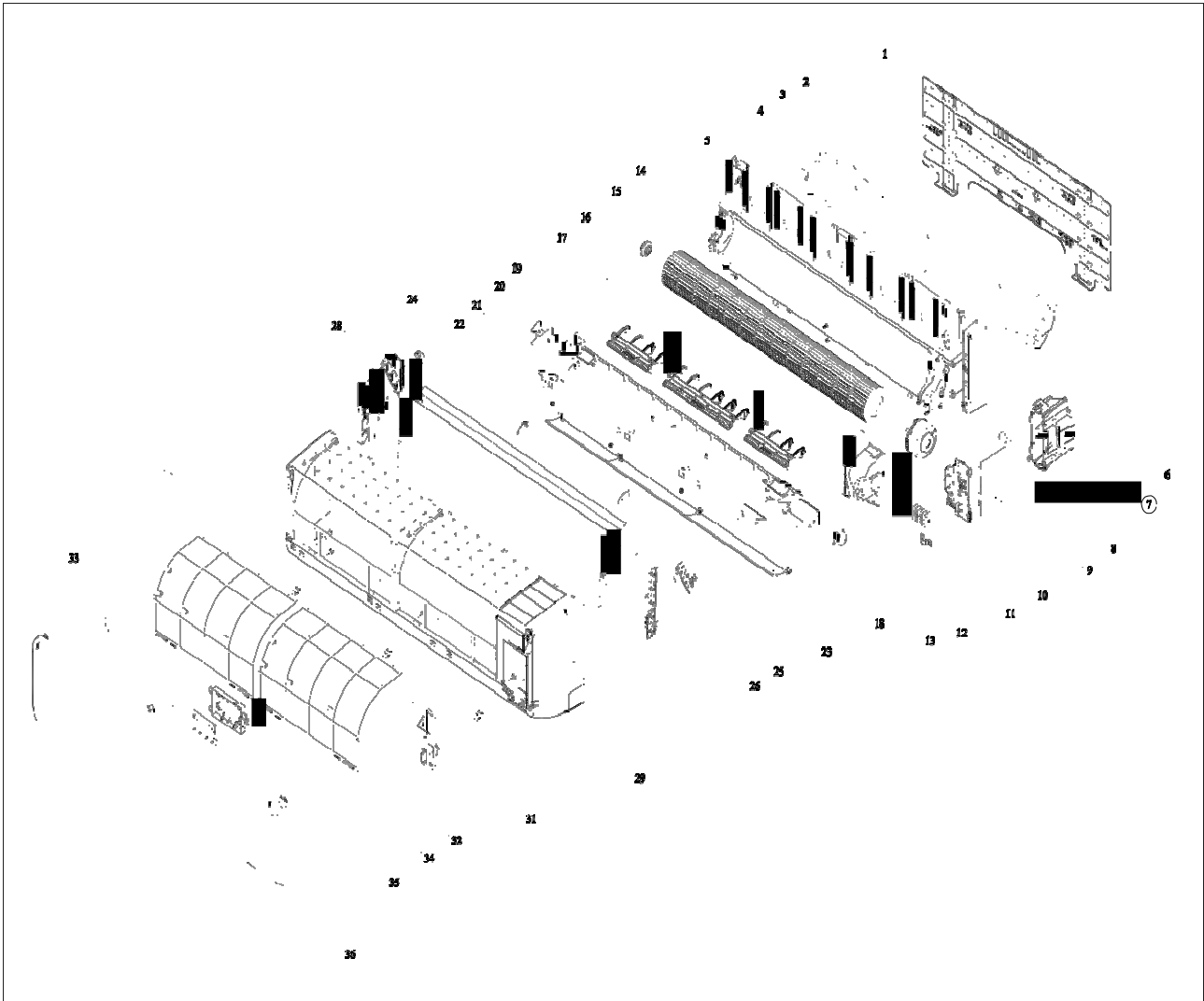

| No | Description | Quantity | No | Description | Quantity |
|----|---------------------------|----------|----|------------------------------|----------|
| 1 | Mounting Plate | 1 | 19 | Tray Drain | 1 |
| 2 | Back Body Right Styrofoam | 1 | 20 | Tray Drain Left Styrofoam | 1 |
| 3 | Back Body Styrofoam | 1 | 21 | Tray Drain Styrofoam | 1 |
| 4 | Back Body Left Styrofoam | 1 | 22 | Horizontal Blade PIM Bearing | 3 |
| 5 | Back Body | 1 | 23 | Horizontal Blade | 1 |
| 6 | Control Box | 1 | 24 | Evaporator Profile | 1 |
| 7 | Ionizer | 1 | 25 | Evaporator Holder Plate 1 | 1 |
| 8 | Pcb | 1 | 26 | Evaporator Holder Plate 2 | 1 |
| 9 | Control Box Cover | 1 | 27 | Evaporator | 1 |
| 10 | Terminal Block | 1 | 28 | Cross Fan Cover | 1 |
| 11 | Cable Holder | 1 | 29 | Front Panel | 1 |
| 12 | Cross Fan Motor | 1 | 30 | Screw Cover | 3 |
| 13 | Cross Fan Motor Cover | 1 | 31 | Terminal Cover | 1 |
| 14 | Cross Fan | 1 | 32 | Dust Filter | 2 |
| 15 | Cross Fan Bearing | 1 | 33 | Display Box | 1 |
| 16 | Vertical Blade 4 | 2 | 34 | Display | 1 |
| 17 | Vertical Blade 6 | 1 | 35 | Front Cover | 1 |
| 18 | Step Motor | 1 | | | |

14. EXPLODED VIEW OUTDOOR UNIT

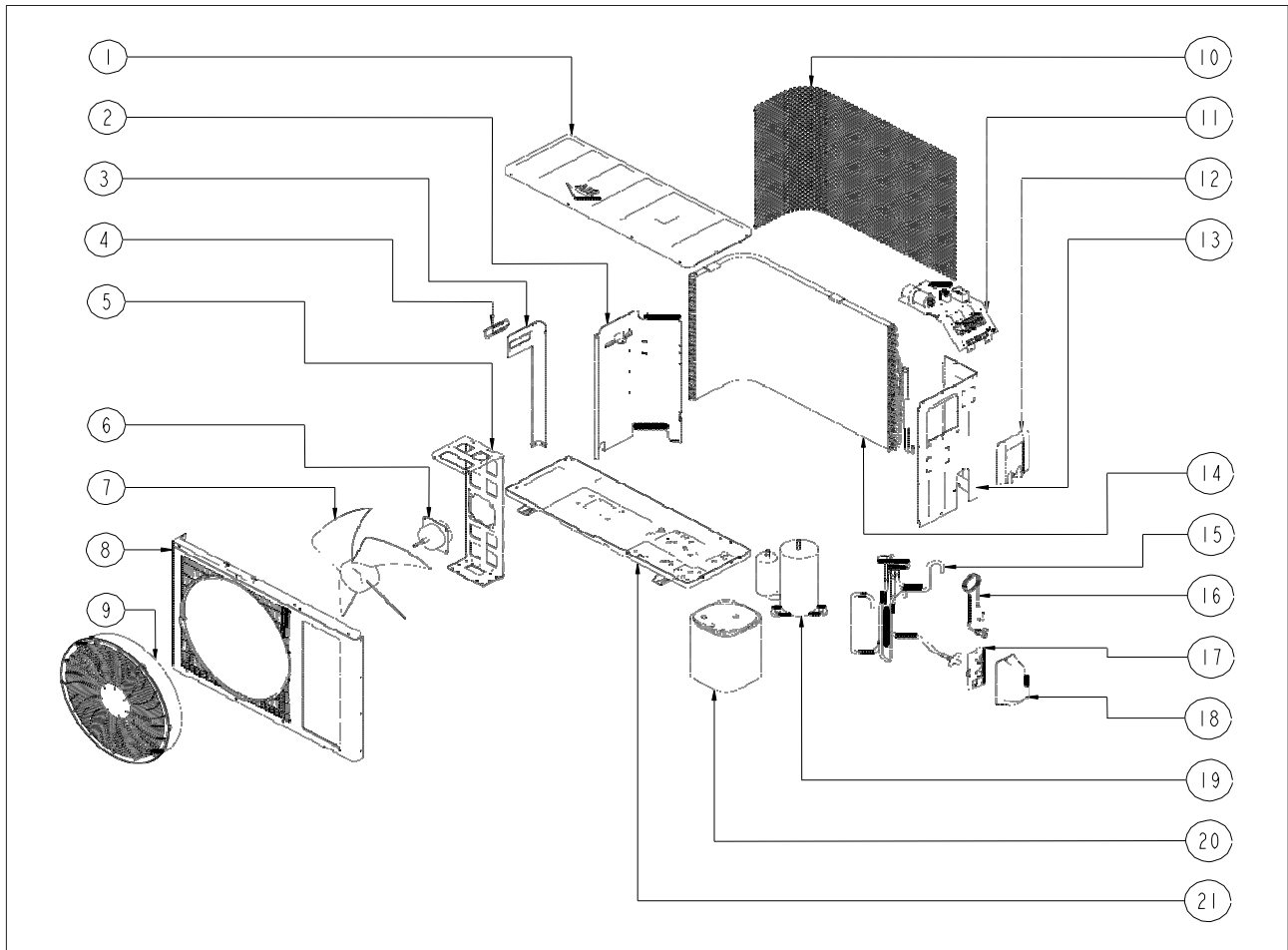

| No | Description | Quantity |
|----|--------------------|----------|
| 1 | Top Panel | 1 |
| 2 | Isolation Sheet | 1 |
| 3 | Left Side Blade | 1 |
| 4 | Holder | 1 |
| 5 | Motor Support | 1 |
| 6 | Fan Motor | 1 |
| 7 | Axial Fan Blade | 1 |
| 8 | Front Panel | 1 |
| 9 | Front Panel Grille | 1 |
| 10 | Condenser Cover | 1 |
| 11 | Electric Box | 1 |
| 12 | Big Holder | 1 |
| 13 | Right Side Plade | 1 |
| 14 | Condenser | 1 |
| 15 | 4 Way Valve | 1 |
| 16 | Capillary Tube | 1 |
| 17 | Valve Bracket | 1 |
| 18 | Valve Cover | 1 |
| 19 | Compressor | 1 |
| 20 | Sound Proof Sponge | 1 |
| 21 | Base Panel | 1 |

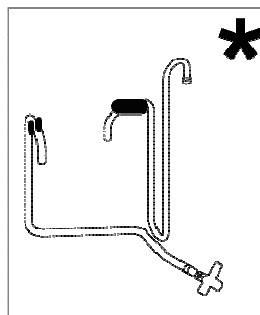

* Cooling Only models includes discharge & suction

EN

ZANUSSI

599 82 80 - 32 Rev. 00