



© ELECTROLUX HOME PRODUCTS
Customer Care – EMEA
Training and Operations Support
Technical Support

Publication
number

599 76 05-82

Edition: 05/2012 – Rev. 00

EN

Tumble dryer

**INSPIRATION
RANGE**

BLUE FIRE

INDEX

1	Safety and Installation	4
1.1	Safety measures	4
1.2	Setting up	5
2	Technical characteristics	6
2.1	Power supply management	7
3	Symbols	8
3.1	Drying programme symbols	8
3.2	Drying programme phase icons	8
3.3	Available	8
3.4	Warnings	8
4	Control panel	9
4.1	TC4 Series	9
4.1.1	Programme selector	9
4.1.2	Option buttons	10
4.1.3	Start/Pause	12
4.1.4	Key combinations	13
4.1.5	Warning Icons	16
4.2	TC3	17
4.2.1	Programme selector	17
4.2.2	ON/OFF button	18
4.2.3	Option buttons	19
4.2.4	Start/Pause	21
4.2.5	Key combinations	22
4.2.6	Warning Icons	25
4.3	TC2	26
4.3.1	Programme selector	26
4.3.2	ON/OFF button	27
4.3.3	Option buttons	28
4.3.4	Start/Pause	32
4.3.5	MEMORY Key	33
4.3.6	Key combinations	34
4.3.7	Warning Icons	38
4.4	TC1	39
4.4.1	Programmes	39
4.4.2	ON/OFF button	40
4.4.3	Option buttons	41
4.4.4	Start/Pause	45
4.4.5	MEMORY Key	46
4.4.6	Key combinations	47
4.4.7	Warning Icons	52
5	Selector dial positions in diagnostics	53
6	Alarms	57
6.1	Alarm display during normal operation	57
6.2	Reading the alarms	57
6.3	Cancelling the last alarm memorised	58
6.4	Notes about specific alarm codes	58
6.5	ALARMS TABLE	59
7	Revisions	64

1 Safety and Installation

1.1 Safety measures



- Before starting work on an appliance, check that the earth in the lodgings is working properly by using an appropriate tool and follow the instructions described/illustrated on the Electrolux Learning Gateway portal
<http://electrolux.edvantage.net>
- This platform is not fitted with an ON/OFF switch. Before you access internal components, take the plug out of the socket to disconnect the power supply.
- When the servicing is completed, ensure that all the connections have been made properly and that all the appliance's safety conditions are as good as new.
- The connection between the earth terminal and the earthed metallic parts must have a low resistance.
- Servicing must be performed using a tool suitable for measuring the earthing connection in compliance with the IEC/EN 60335-1 standard and follow the instructions described/illustrated on the Electrolux Learning Gateway/Metratester portal
<http://electrolux.edvantage.net>
- The resistance reading taken during the trial should not exceed 0.1 Ohm.
- In the event of handling/replacing the electronic circuit board, use the ESD (Cod. 405 50 63-95/4) kit to avoid electrostatic discharges damaging the electronic circuit board, see S.B. No. 599 72 08-09.
- All the work to be performed inside the appliance requires specific skills and knowledge and may only be carried out by qualified and authorised service engineers.
- Some of the components in the mechanical part could cause injuries, so wear suitable protection and proceed with caution.
- If the compressor needs to be replaced, it must be welded and not connected via Lokring type connections.
- Always empty all the water from the condensation tank before laying the appliance on its side.
- If the appliance has to be placed on its side for maintenance or another reason, lie it on its left side, to avoid the risk of any residual water falling onto the main circuit board.
- When replacing components, please refer to the code shown in the list of spare parts relating to the appliance.

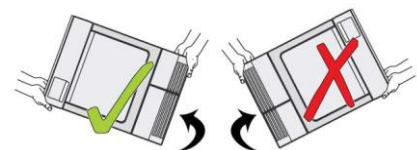
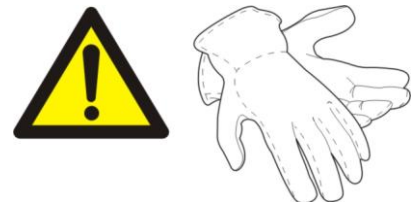

1.2 Setting up

Remove the external film. If necessary use a cutter blade.

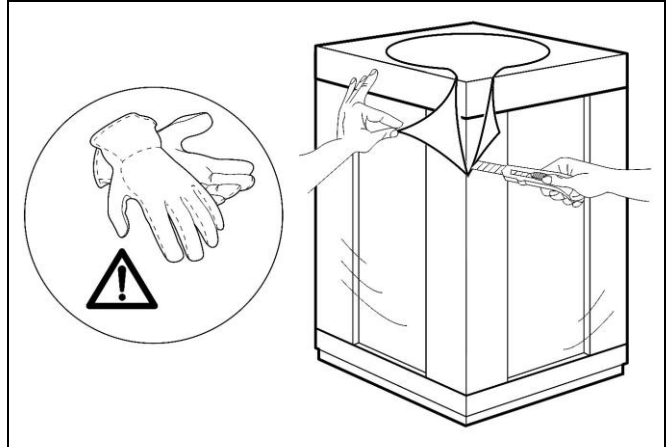

Take off the cardboard cover and remove the corner elements.

Remove the polystyrene base and set the tumble dryer in position.



The tumble dryer weighs approximately 40 kg.

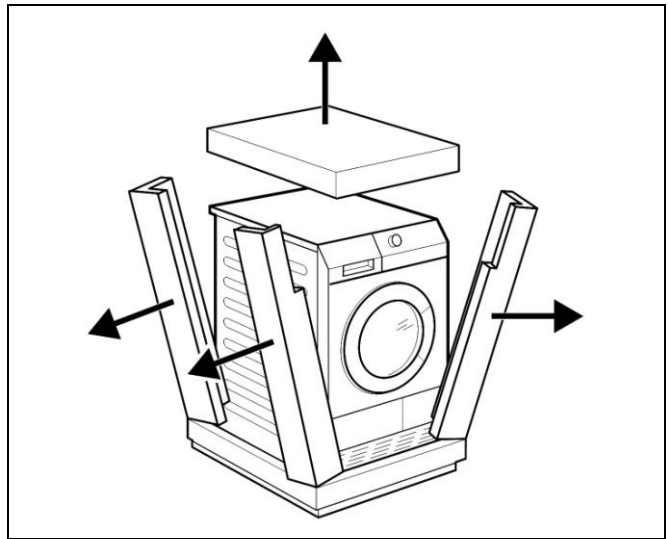

Adjust the four feet so that the appliance is installed perfectly level (using a spirit level), to allow for the correct flow of condensation water into the purpose-provided tank.



The feet must never be removed. A gap must always be left between the bottom of the tumble dryer and the floor to prevent the appliance from overheating.

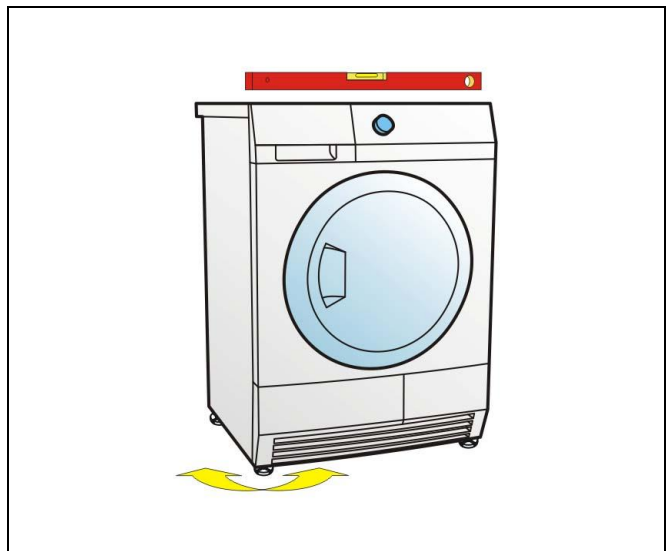

2 Technical characteristics

Power supply voltage.	230 V	
Power supply frequency	50 Hz	
Energy class	T IT	
Maximum power absorption	1,050 W	900 W
Maximum energy consumed per 1 hour cycle	1.6 KW/h	1.85 KW/h
Drum volume	118 litres	
Foot adjustment	+1.5 cm	
Weight	approx. 40 kg	
Operating temperature	+5°C/+35°C	

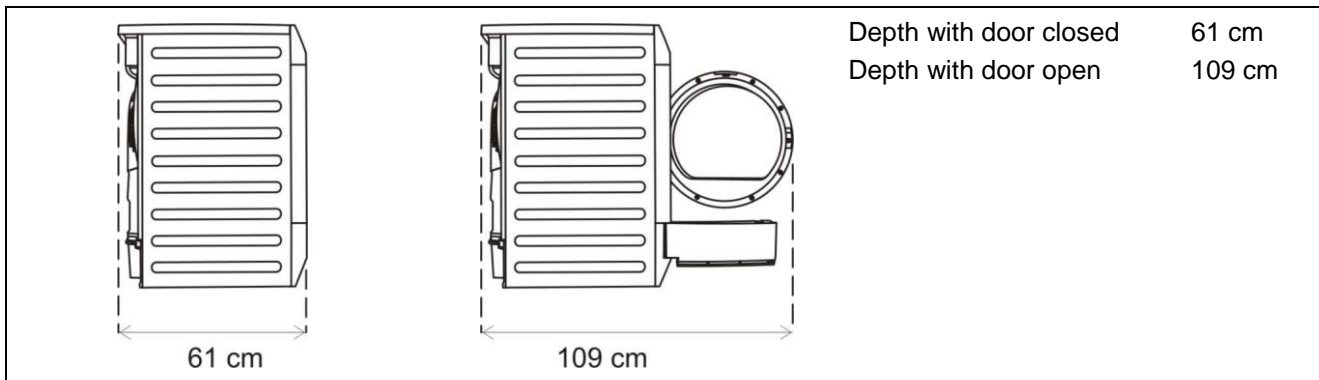
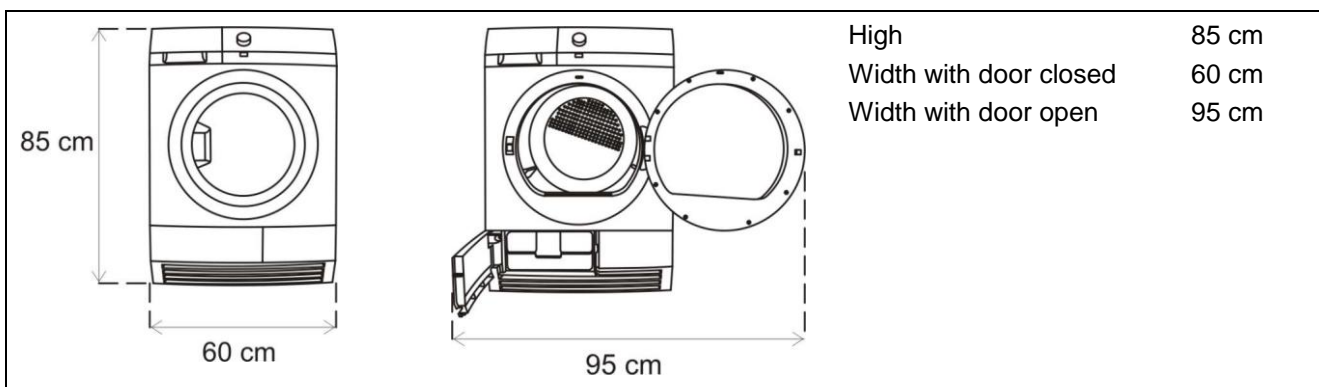

2.1 Power supply management

Depending on the characteristics of the main circuit board, and irrespective of the model, the appliance can be completely cut off from the mains, or alternatively set to a special, lower energy consumption mode.

When the 0 Watt power supply circuit is inserted in the main circuit board, the appliance consumption is automatically cut to 0.

Without this circuit, for users to get a power absorption of 0 (zero) Watts, they have to cut off the electricity supply by unplugging the appliance.

In either case, the user interface behaviour is the same.

To turn the appliance on, simply press the ON/OFF button briefly.

The appliance BEEPS once (if the buzzer is enabled), and depending on the selected programme, the display shows the time required to complete drying.

To turn off the appliance, hold down the button for approximately 1 second.

After this time, the user interface beeps once (if the buzzer is enabled) and all the lights and the display are turned off. After turning off the dryer, all the options selected and the programme are deleted.

- **Behaviour in Stand-Off mode**

In order to minimise electricity wastage when the cycle is not under way, appliances in this platform offer the auto-off function which, when teamed with the Zero -Watt circuit, provide two ways of enabling a low consumption mode:









1. When you press the ON/OFF button to turn off the appliance, the power supply is disconnected and the tumble dryer is secured (motor off, display off, etc...), the cycle and any options selected are reset, so that the next time the appliance is turned on, it is ready to perform a new programme.
2. If, during the programme and options selection phase or after the end of the cycle, the appliance receives no further instructions for at least 5 minutes, it turns off automatically (to save energy in compliance with energy consumption standards).
 - If this occurs during the setting phase, the programme and the options selected are cancelled and the basic programme appears when the appliance is turned back on.
 - If, however, the cycle has ended, all the settings are stored so that when the appliance is turned back on, the user can see that the cycle ended normally, and can restart it if necessary.







If an alarm occurs while a programme is under way, the auto off function is disabled, and an alarm is displayed.

3 Symbols



3.1 Drying programme symbols

 Extra Dry	 Extreme drying
 Cupboard Dry	 Iron Dry
 Extra silent	 Reverse plus
 Time-controlled drying	 Extra delicate





3.2 Drying programme phase icons

 Dry phase	 Cooling phase
 Anti-crease guard phase	 Anti-crease guard phase

3.3 Available

 Buzzer	 The Child Safety Device
 Delaying the start time	

3.4 Warnings

 Water collection tank warning	 Clean fluff filter warning
 Clean heat exchanger warning	 Clean heat exchanger warning

4 Control panel

Condensation tumble dryers with a heating element air heating system differ in that 3 stylings are available:

- TC4 Series
- TC3 Series
- TC2 Series
- TC1 Series

4.1 TC4 Series

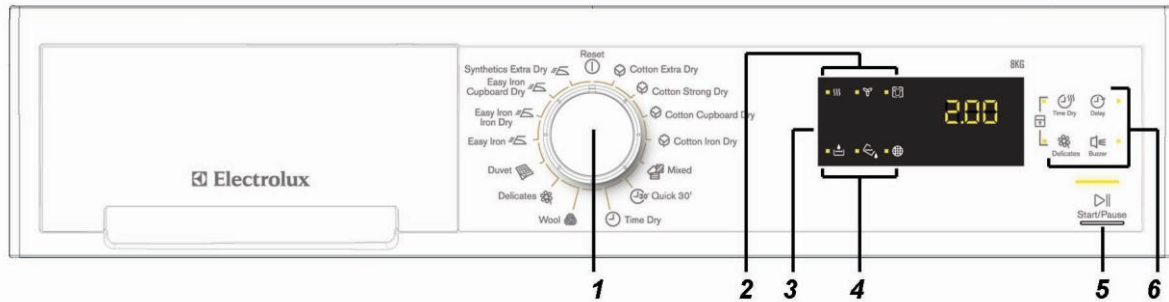

- | | |
|--|----------------------------|
| 1. 15 position programme selector dial | 4. Alarms |
| 2. Cycle phases | 5. Start/Pause button |
| 3. LCD display | 6. Functions touch buttons |

4.1.1 Programme selector

The selector is used to select the desired washing programme or to restore the cycle in progress; it can be turned both clockwise and anti-clockwise.

There are 15 positions available (including the reset position) which cannot be configured; the remaining 14 can be configured according to the model.

The central position  is used for the "ON/OFF" function where, in this position, the programme underway is suspended and reset.

When the selector is set in this position, the user interface turns off completely.

4.1.2 Option buttons.

The option buttons are used to change the selected programme according to personal requirements:

- Delayed Start.
- Acoustic signal (buzzer).
- Delicate drying.
- Time-controlled drying.

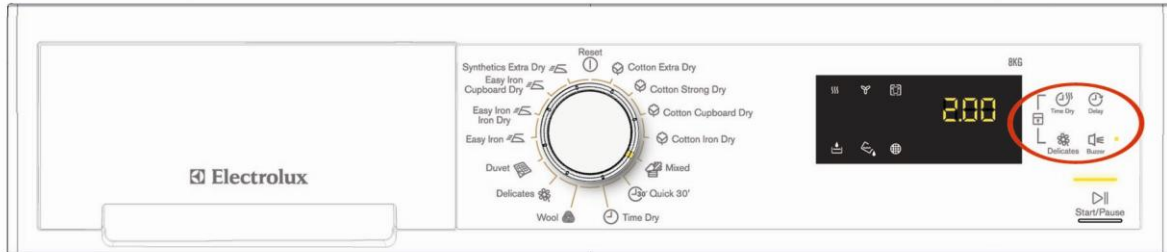

Press one or more buttons to enable or disable the relevant options.

When one or more options have been enabled, the related LEDs and icons are lit and if the options picked affect the cycle time, the display will automatically be updated.

a) Delayed Start

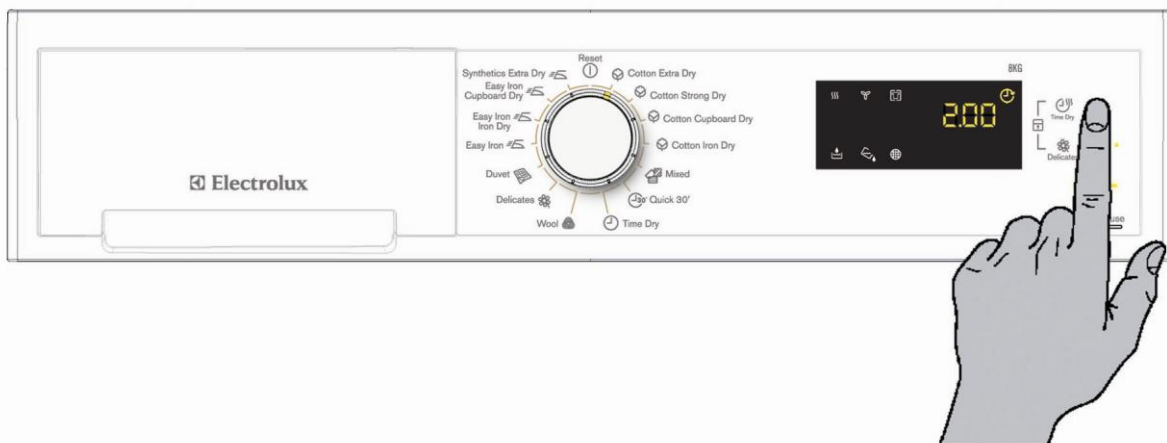

Press this button to postpone the selected programme start.

Once you have pressed this button, the related LED and icon  are lit and the display shows 30'.

To increase the time, press the button repeatedly or hold it down: the time will change in 30-minute steps for up to 90 minutes max, then the time will change in one-hour steps up to a maximum of 20 hours.

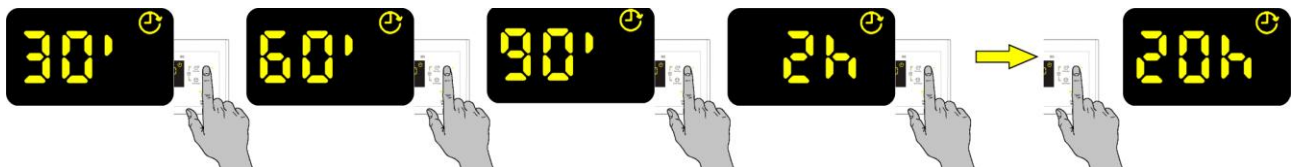

When a delayed start is set, the relevant LED is lit, and stays on for the entire duration of the cycle.

Press the START/PAUSE button to begin the countdown; the display will show the minutes left until the cycle starts.

After the countdown has begun, it can be stopped by pressing the ON/OFF button or by resetting the selected programme by turning the selector to the central position .

b) Acoustic signal (buzzer)

This option enables or disables the buzzer sound permanently even after the machine is turned off or following a programme change.

When the alarm is enabled (default configuration), the LED associated with the key is lit.

c) Delicate drying

This option is not enabled on all programmes. When this option is selected, only one branch of the heating element is activated, thus reducing power and consequently the drying temperature.

After selecting this option, the time shown on the display is updated automatically.

d) Time-controlled drying

Select the time-controlled programme on the selector dial in order to set the desired drying time by pressing the TIME button.

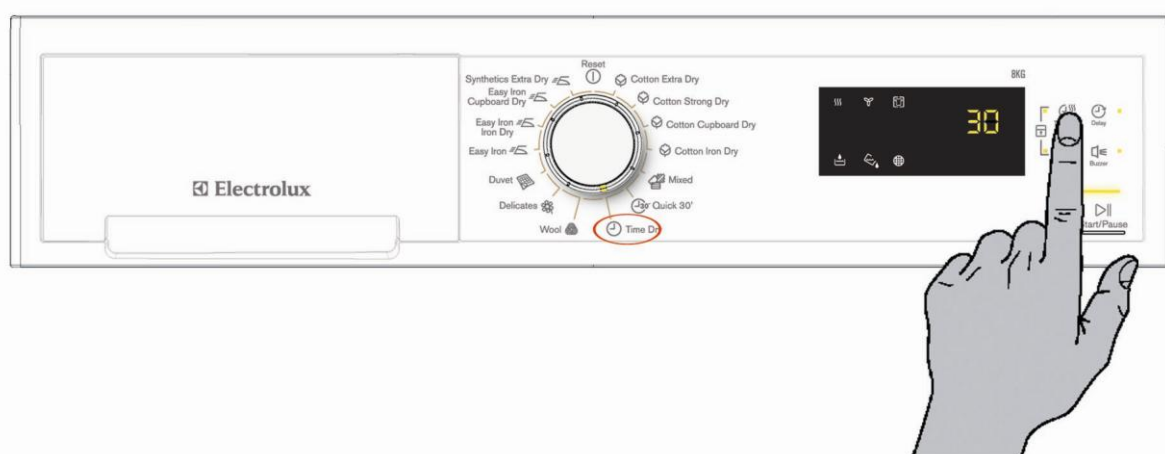

When the TIME button is pressed, the corresponding LED is lit and each time the button is pressed or if the button is held own, the time increases in 10-minute steps, from a minimum of 10 minutes to a maximum of 120 minutes (2 hours).

If you reach the maximum time, the next step resets the timer to 0 (zero).

4.1.3 Start/Pause

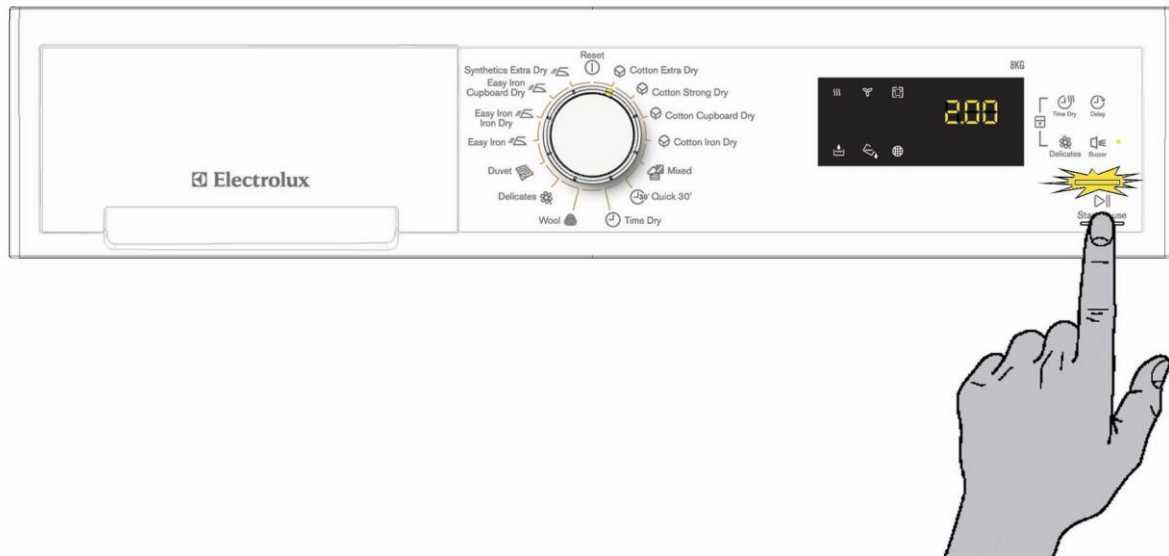

When a programme is selected and the appliance door is closed, simply press the Start/Pause button to start the cycle.

The corresponding LED will stop flashing and will remain lit permanently, while the display is consequently updated.

Should the door not be closed, the display will not show the time left until the end of the cycle but error "Err" and the LED will flash

After removing the error by closing the door, press Start/Pause again for the cycle to start up again.

Press the Start/Pause button during the cycle to pause the appliance.

When the appliance is on pause, you can add or remove options, but you cannot change the programmes; to do this, in this case, you need to turn off the tumble dryer at the On/Off button, or reset the programme by turning the programme selector dial to the central position ①.

4.1.4 Key combinations

Some extra options or operating modes can be selected using specific key combinations. The functions available and the related key combinations to set them are:

- Child lock.
- Enable or disable buzzer.
- Change water conductivity.
- Demo mode.
- Diagnostics.

- **Child Lock**

Simultaneously press the keys indicated in the figure to set the child safety device and keep them pressed down until you hear a beep and the corresponding icon comes on .



This command blocks the user interface to prevent children from modifying the programme and keeps this function enabled even after the appliance has been turned off; once this option has been enabled, no further programme changes or option additions can be made.

To disable the child lock, press the above key combination again.

- **Enabling or disabling the buzzer**

Press the buttons indicated in the figure simultaneously to enable or disable the buzzer sounding permanently even after the appliance has been turned off or the programme has been changed.

When the alarm is enabled (default configuration), the LEDs associated with the key and icon  are lit.

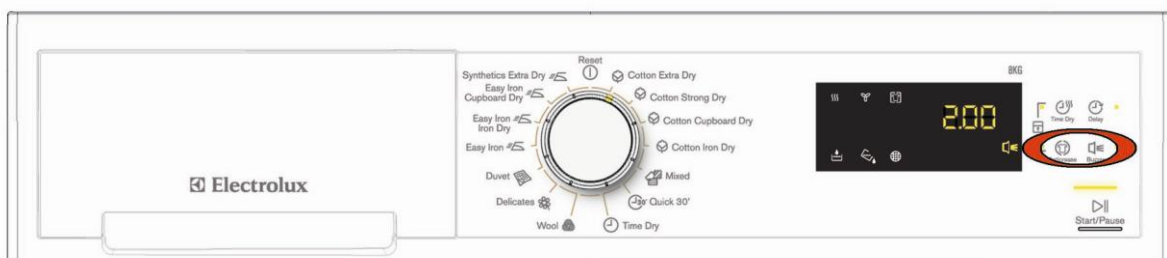

- **Water conductivity**

The conductivity of the water used to wash the laundry varies from area to area; the conductivity sensor is set to a standard level, significant variations in conductivity level may have a negative effect on the final results of drying (laundry that is either too dry or still damp).

These variations can be noted particularly in “slightly damp” and “ready-to-iron” cycles; “wardrobe dry” cycles are practically never influenced by changes in conductivity.

In order to access adjustment mode turn on the tumble dryer by rotating the programme selector clockwise by 1 position and simultaneously pressing the keys as shown in the figure

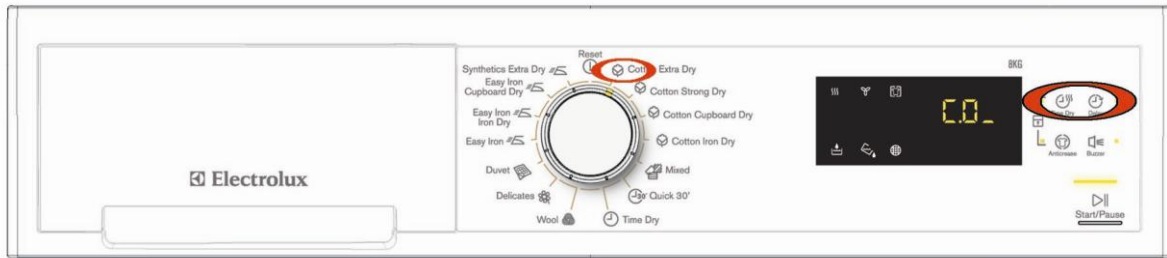

To change the conductivity value according to the table, press the **Start/Pause** button.

LCD	Conductivity level	Approximate value ($\mu\text{S}/\text{cm}$)
	LOW	< 300
	MEDIUM	300 – 600
	HIGH	> 600

The normal factory setting is medium level, but some models may have a different configuration.

Ask your local water supplier for details of the conductivity level of your water supply.

- **Demo mode**

The Demo mode is particularly used in showrooms to demonstrate to customers how the appliance works, by simulating the drying cycle.

In order to access demo mode turn on the tumble dryer by rotating the programme selector clockwise by 3 positions and simultaneously pressing the keys as shown in the figure.



Do this within 5 seconds after the tumble dryer has been turned on.



The Demo mode remains enabled even after the tumble dryer has been turned off at the ON/OFF button. When the ON/OFF button is pressed to restart the appliance, the display will show DEM for a few seconds, to facilitate the use of the Demo function in a showroom.

To quit demo mode, disconnect the electricity supply to the tumble dryer.

- **Diagnostics**

The diagnostics process is designed to check all the components in the tumble dryer.

To enter diagnostics mode, proceed as follows:

Turn the selector dial clockwise to the first position.

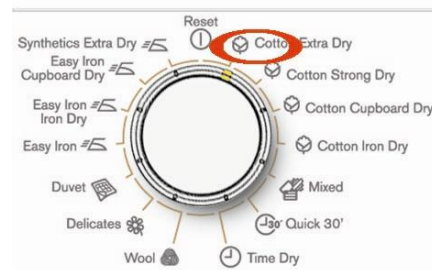

Press the keys shown in the figure simultaneously.



This must be done within 5 seconds after the tumble dryer has been turned on!

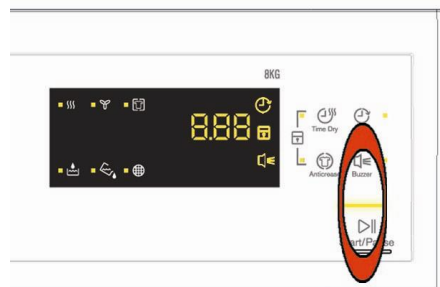

- **Quitting diagnostics mode**

To quit diagnostics mode, turn the tumble dryer off at the ON/OFF button, then turn it back on in order to reset it. The display shows **ELE** then turn it back off.

- **Selector dial positions in diagnostics**

See the paragraph which applies to all stylings “SELECTOR DIAL POSITION IN DIAGNOSTICS”.

4.1.5 Warning Icons

There are three LEDs on the display    dedicated to showing warnings, to remind the user to perform specific operations.

- **Condenser**

It lights up at the end of the cycle only after approximately 100 hours of operation, to remind the user to clean the condenser at the bottom of the tumble dryer.



- **Condensation water tank**

It lights up at the end of every cycle to remind the user to empty the condensation water collection tank or during the actual cycle if it is full.

This warning can be disabled using the dedicated key combination if the water drain kit is fitted in the tumble dryer.



- **Filter or needle trap**

It lights up at the end of every cycle to remind the user to clean the fluff filter in the air conduit.



4.2 TC3

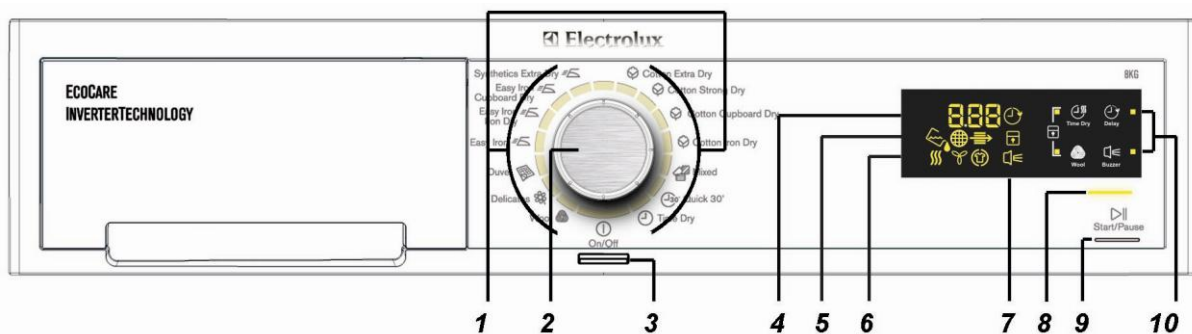

- | | |
|--|-------------------------------------|
| 1. Programmes | 6. Drying phases |
| 2. 16 position programme selector dial | 7. Option icons |
| 3. ON/OFF button | 8. Start/Pause LED |
| 4. Digit | 9. Start/Pause push button |
| 5. Warning icons | 10. Functions leds and push buttons |

4.2.1 Programme selector

The selector dial fitted on the TC3 series is referred to as the HI-FI selector and it is used to select the desired washing programme; it can be turned both clockwise as well as anti-clockwise.

There are 14 selector positions available, and they can all be configured.

Compared to a traditional selector dial (see TC4 series), the Hi-fi selector does not have an index on the dial or a reset position, the dial itself does not indicate a position on the control panel, but instead allows the selected programme to be indicated by lighting a LED associated with the programme.

To reset a cycle in progress, simply press the On/Off button.

When the appliance is turned on, the first position at the top right is selected by default (except in special circumstances, for instance, if there is a power failure).

When the selector dial is turned clockwise or anti-clockwise, the corresponding LED associated with a programme lights up and the LCD display shows the time required for drying and the programme phases concerned.

4.2.2 ON/OFF button

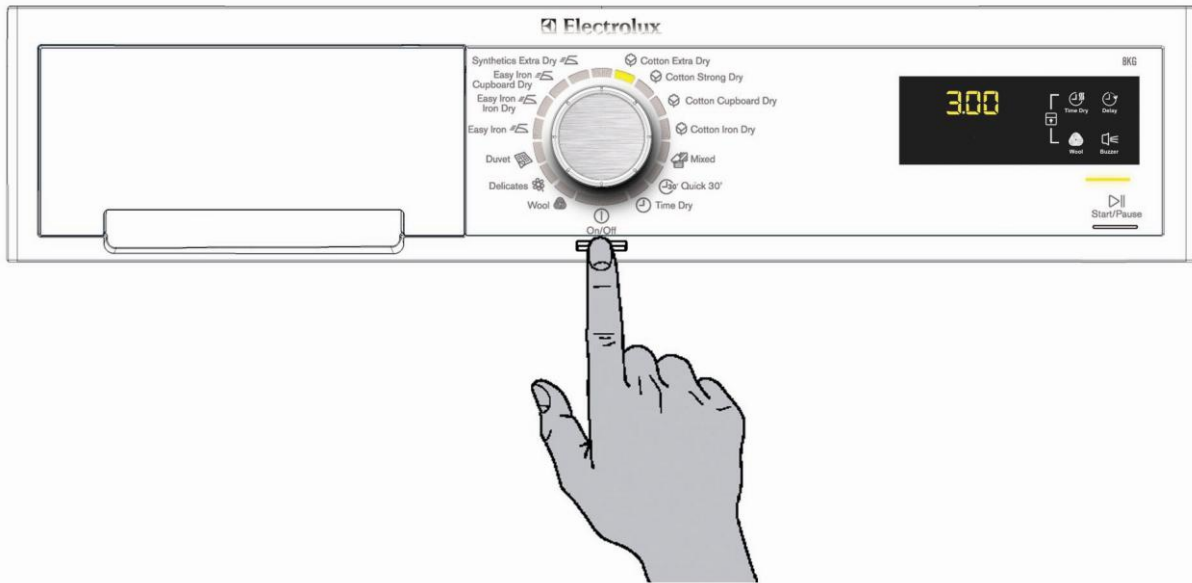

Press the ON/OFF button to turn on the appliance; the first position at the top right is selected by default (except in special circumstances, for instance, if there is a power failure), the display shows the amount of time required for drying to be completed and the three icons corresponding to the drying, cooling, anti-crease phases are lit.

The time shown on the display should not be considered as a set time, since it is calculated according to a normal load with a given humidity, and obviously if the appliance load is lighter or the degree of humidity of the fabrics in the appliance is different, the time will change automatically and gradually as drying progresses.

4.2.3 Option buttons

The option buttons are used to change the selected programme according to personal requirements:

- a) Delayed Start.
- b) Acoustic signal (buzzer).
- c) Delicate drying.
- d) Time-controlled drying.



Press one or more buttons to enable or disable the relevant options.

When one or more options have been enabled, the related LEDs and icons are lit and if the options picked affect the cycle time, the display will automatically be updated.

a) Delayed Start

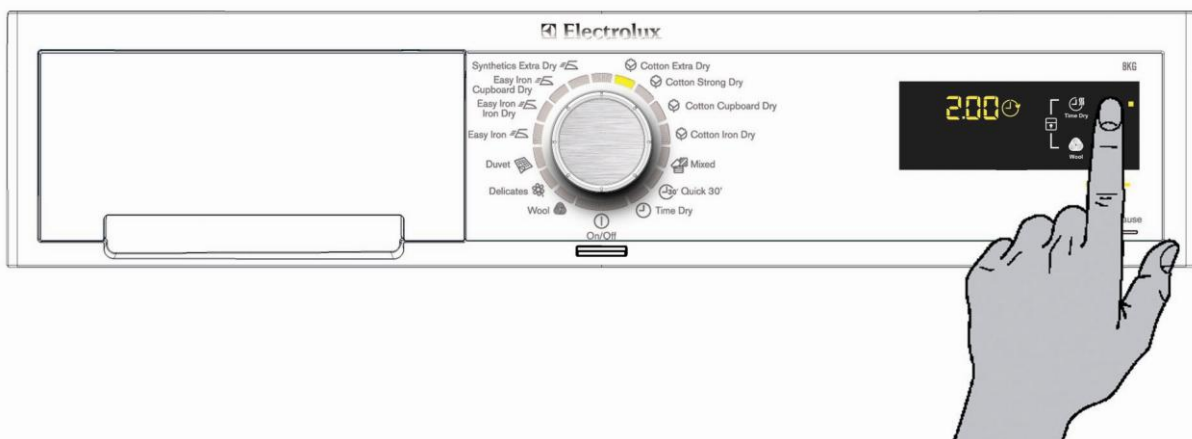

Press this button to postpone the selected programme start.

Once you have pressed this button, the related LED and icon  are lit and the display shows 30'.

To increase the time, press the button repeatedly or hold it down: the time will change in 30-minute steps for up to 90 minutes max, then the time will change in one-hour steps up to a maximum of 20 hours.

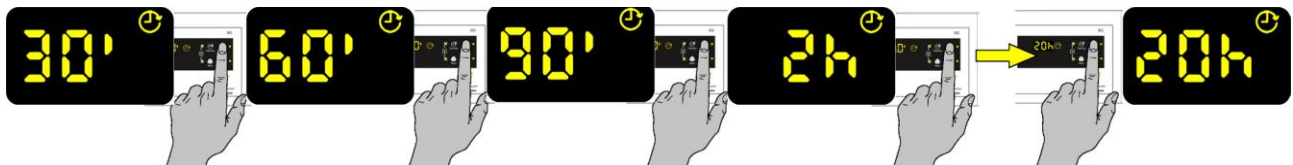

When a delayed start is set, the relevant LED is lit, and stays on for the entire duration of the cycle.

Press the START/PAUSE button to begin the countdown; the display will show the minutes left until the cycle starts.

After the countdown has begun, it can be stopped by pressing the ON/OFF button or by resetting the selected programme by turning the selector to the central position .

b) Acoustic signal (buzzer)

This option enables or disables the buzzer sound permanently even after the machine is turned off or following a programme change.

When the alarm is enabled (default configuration), the LED associated with the key is lit.

c) Delicate drying

This option is not enabled on all programmes. When this option is selected, only one branch of the heating element is activated, thus reducing power and consequently the drying temperature.

After selecting this option, the time shown on the display is updated automatically.

d) Time-controlled drying

Select the time-controlled programme on the selector dial in order to set the desired drying time by pressing the TIME button.

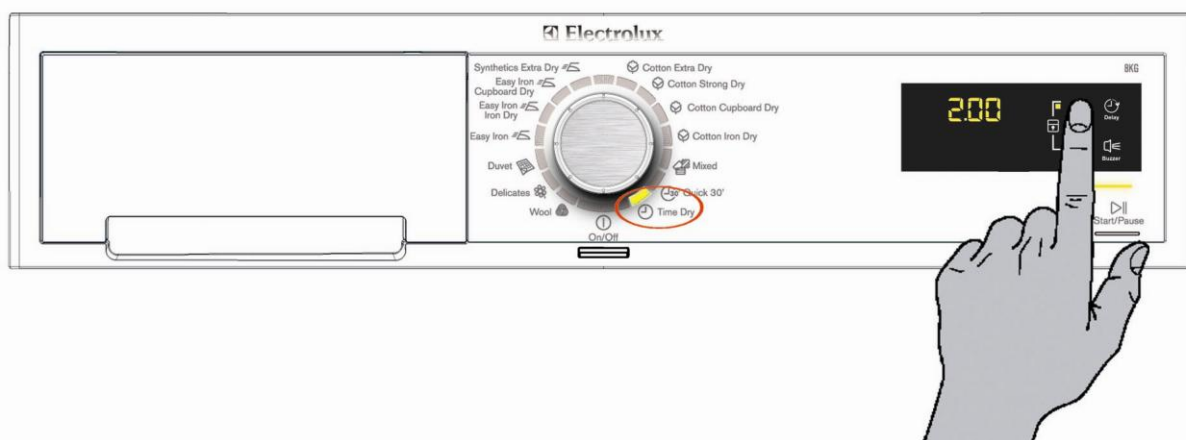

When the TIME button is pressed, the corresponding LED is lit and each time the button is pressed or if the button is held own, the time increases in 10-minute steps, from a minimum of 10 minutes to a maximum of 120 minutes (2 hours).

If you reach the maximum time, the next step resets the timer to 0 (zero).

4.2.4 Start/Pause

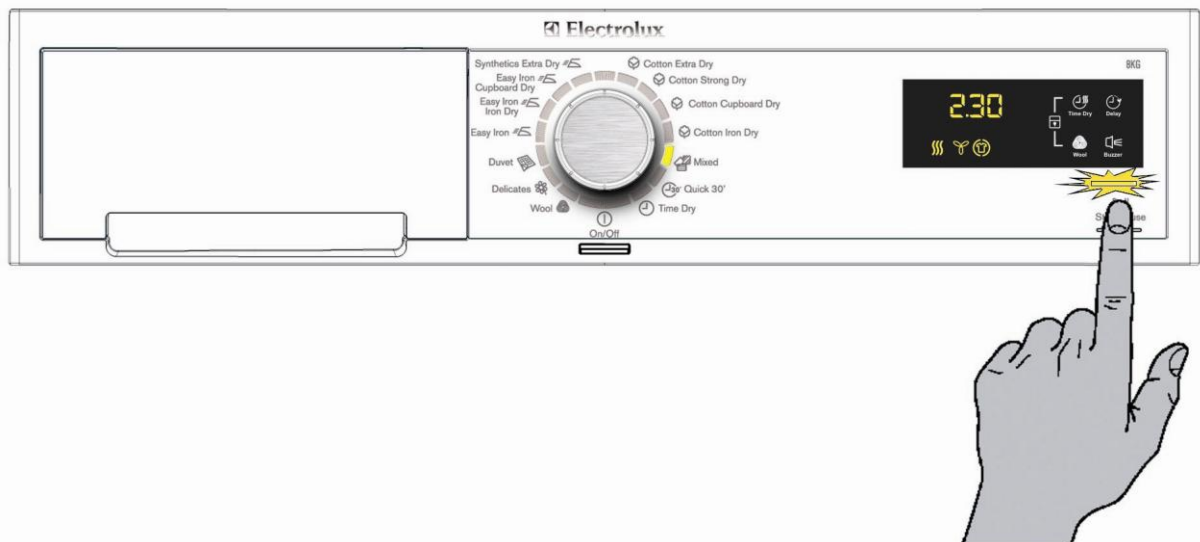

When a programme is selected and the appliance door is closed, simply press the Start/Pause button to start the cycle.

The corresponding LED will stop flashing and will remain lit permanently, the icon depicting the cycle phase in progress will begin to flash while the display updates the amount of time left accordingly.

Drying phase flashing 

Cooling phase flashing 

Anti-crease phase flashing 

Should the door not be closed, the display will not show the time left until the end of the cycle but error "Err" and the LED will flash

After removing the error by closing the door, press Start/Pause again for the cycle to start up again.

Press the Start/Pause button during the cycle to pause the appliance.

When the appliance is on pause, you can add or remove options, but you cannot change the programmes; to do this, in this case, you need to turn off the tumble dryer at the On/Off button.

4.2.5 Key combinations

Some extra options or working modes can be selected via key combinations.

The available functions and relative key combinations to be set are:

- Child lock.
- Enable or disable buzzer.
- Change water conductivity.
- Demo mode.
- Diagnostics.

- **Child Lock**

Simultaneously press the keys indicated in the figure to set the child safety device and keep them pressed down until you hear a beep and the corresponding icon comes on .



This command blocks the user interface to prevent children from modifying the programme and keeps this function enabled even after the appliance has been turned off; once this option has been enabled, no further programme changes or option additions can be made.

To disable the child lock, press the above key combination again.

- **Enabling or disabling the buzzer**

Press the buttons indicated in the figure simultaneously to enable or disable the buzzer sounding permanently even after the appliance has been turned off or the programme has been changed.

When the alarm is enabled (default configuration), the LEDs associated with the key and icon  are lit.



- **Water conductivity**



The conductivity of the water used to wash the laundry varies from area to area; the conductivity sensor is set to a standard level, significant variations in conductivity level may have a negative effect on the final results of drying (laundry that is either too dry or still damp).

These variations can be noted particularly in “slightly damp” and “ready-to-iron” cycles; “wardrobe dry” cycles are practically never influenced by changes in conductivity.

To access the adjustment mode, turn on the tumble dryer at the ON/OFF button and simultaneously press the keys shown in the figure.



To change the conductivity value according to the table, press the **Start/Pause** button.

LCD	Conductivity level	Approximate value (µS/cm)
	LOW	< 300
	MEDIUM	300 – 600
	HIGH	> 600

The normal factory setting is medium level, but some models may have a different configuration.

Ask your local water supplier for details of the conductivity level of your water supply.

- **Demo mode**

The Demo mode is particularly used in showrooms to demonstrate to customers how the appliance works, by simulating the drying cycle.

In order to access demo mode turn on the tumble dryer at the ON/OFF button by rotating the programme selector clockwise by 3 positions and simultaneously pressing the keys shown in the figure.



Do this within 5 seconds after the tumble dryer has been turned on.



The Demo mode remains enabled even after the tumble dryer has been turned off at the ON/OFF button. When the ON/OFF button is pressed to restart the appliance, the display will show DEM for a few seconds, to facilitate the use of the Demo function in a showroom.

To quit demo mode, disconnect the electricity supply to the tumble dryer.

- **Diagnostics**

The diagnostics process is designed to check all the components in the tumble dryer.

To enter diagnostics mode, proceed as follows:

Turn on the tumble dryer at the ON/OFF button. Wait for the LEDs to be lit and for the buzzer to BEEP (if the alarm is not disabled).

This is a Hi-Fi selector so the first position is already selected by default.

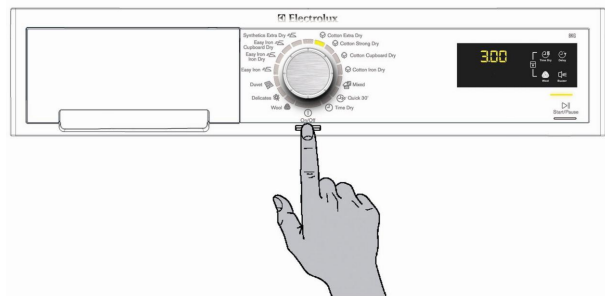

Press the keys shown in the figure simultaneously.



This must be done within 5 seconds after the tumble dryer has been turned on!



- **Quitting diagnostics mode**

To quit diagnostics mode, turn the tumble dryer off at the ON/OFF button, then turn it back on in order to reset it. The display shows **ELE** then turn it back off.

- **Selector dial positions in diagnostics**

See the paragraph which applies to all stylings “SELECTOR DIAL POSITION IN DIAGNOSTICS”.

4.2.6 Warning Icons

There are three LEDs on the display    dedicated to showing warnings, to remind the user to perform specific operations.

- **Condenser**

It lights up at the end of the cycle only after approximately 100 hours of operation, to remind the user to clean the condenser at the bottom of the tumble dryer.



- **Condensation water tank**

It lights up at the end of every cycle to remind the user to empty the condensation water collection tank or during the actual cycle if it is full.

This warning can be disabled using the dedicated key combination if the water drain kit is fitted in the tumble dryer.



- **Filter or needle trap**

It lights up at the end of every cycle to remind the user to clean the fluff filter in the air conduit.



4.3 TC2

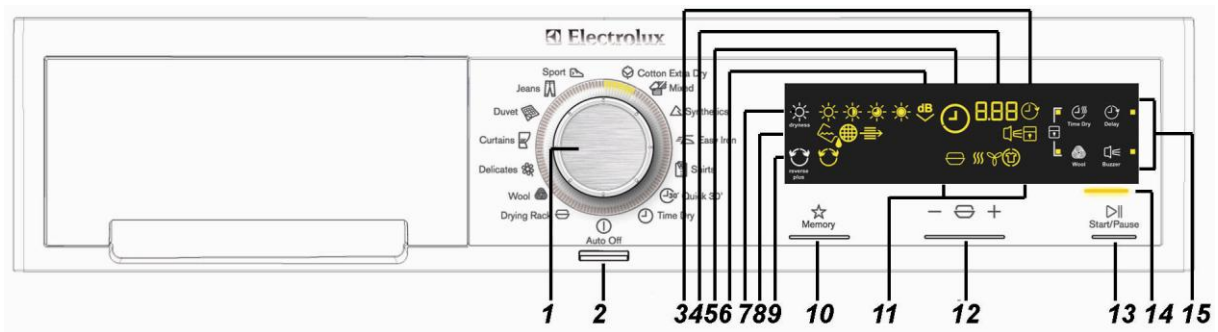

- | | |
|--|-------------------------------------|
| 1. 14 position programme selector dial | 9. Reverse plus push button and led |
| 2. ON/OFF button | 10. Memory push button |
| 3. Option icons | 11. Drying phases |
| 4. Digit | 12. Basket time + or - |
| 5. Basket time | 13. Start/Pause push button |
| 6. Silent programme | 14. Start/Pause LED |
| 7. Drying push button and led | 15. Functions leds and push buttons |
| 8. Warning icons | |

4.3.1 Programme selector

The selector dial fitted on TC2 series is referred to as the HI-FI selector and it is used to select the desired washing programme; it can be turned both clockwise as well as anti-clockwise.

There are 14 selector positions available, and they can all be configured.

Compared to a traditional selector dial (see TC4 series), the Hi-fi selector does not have an index on the dial or a reset position, the dial itself does not indicate a position on the control panel, but instead allows the selected programme to be indicated by lighting a LED associated with the programme.

To reset a cycle in progress, simply press the On/Off button.

When the appliance is turned on, the first position at the top right is selected by default (except in special circumstances, for instance, if there is a power failure).

When the selector dial is turned clockwise or anti-clockwise, the corresponding LED associated with a programme lights up and the LCD display shows the time required for drying and the programme phases concerned.

4.3.2 ON/OFF button

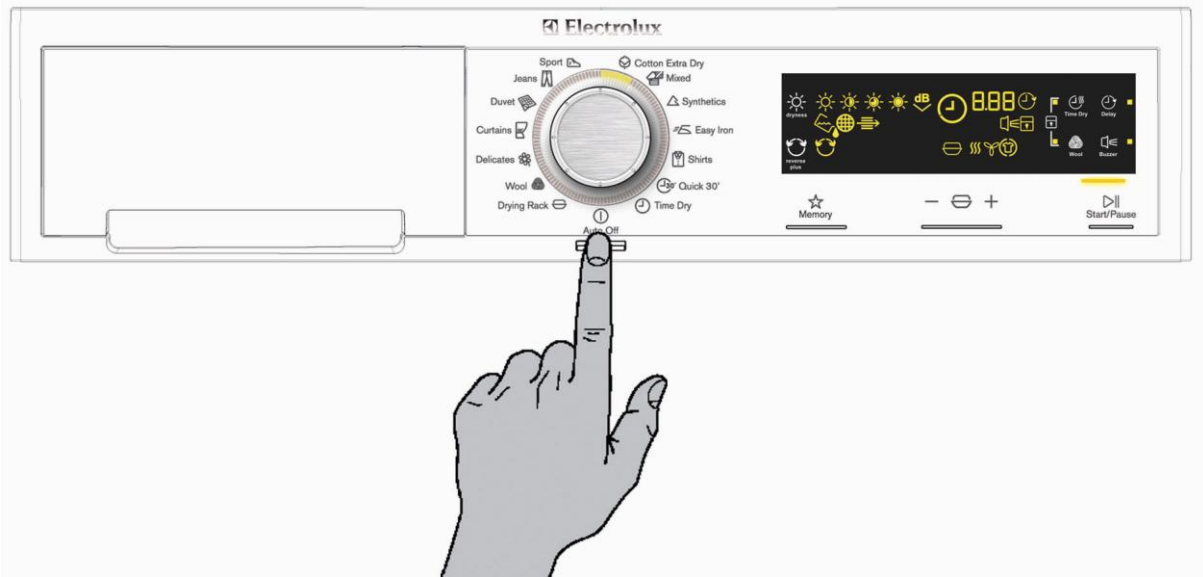

Press the ON/OFF button to turn on the appliance; the first position at the top right is selected by default (except in special circumstances, for instance, if there is a power failure), the display shows the amount of time required for drying to be completed and the three icons corresponding to the drying, cooling, anti-crease phases are lit.

The time shown on the display should not be considered as a set time, since it is calculated according to a normal load with a given humidity, and obviously if the appliance load is lighter or the degree of humidity of the fabrics in the appliance is different, the time will change automatically and gradually as drying progresses.

4.3.3 Option buttons.

The option buttons are used to change the selected programme according to personal requirements:

- a) Acoustic signal (buzzer).
- b) Delay Start.
- c) Delicate drying.
- d) Time-controlled drying.
- e) Reverse plus.
- f) Degree of drying.
- g) Drying with basket.



Press one or more buttons to enable or disable the relevant options.

When one or more options have been enabled, the related LEDs and icons are lit and if the options picked affect the cycle time, the display will automatically be updated.

a) Acoustic signal (buzzer)

This option enables or disables the buzzer sound permanently even after the machine is turned off or following a programme change.

When the alarm is enabled (default configuration), the LED associated with the key is lit.

b) Delayed Start

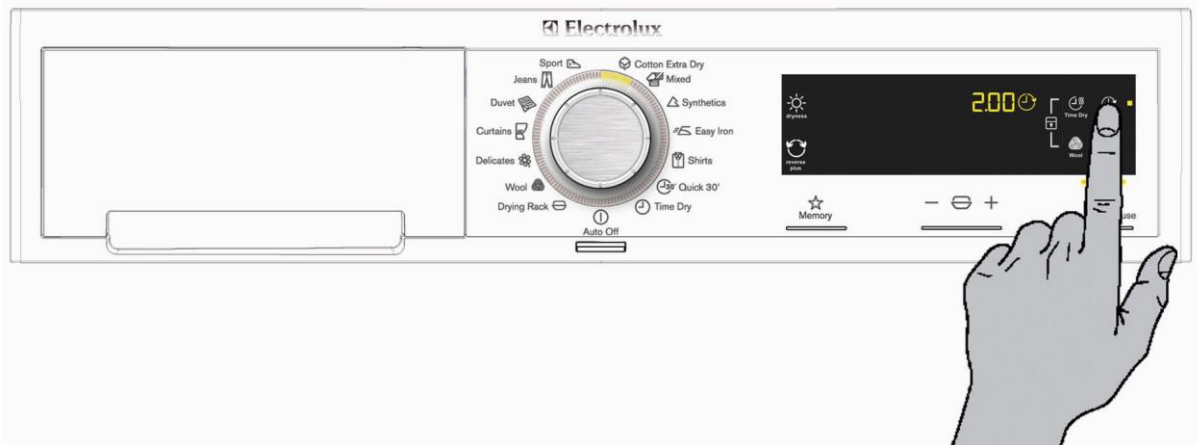

Press this button to postpone the selected programme start.

Once you have pressed this button, the related LED and icon  are lit and the display shows 30'.

To increase the time, press the button repeatedly or hold it down: the time will change in 30-minute steps for up to 90 minutes max, then the time will change in one-hour steps up to a maximum of 20 hours.



When a delayed start is set, the relevant LED is lit, and stays on for the entire duration of the cycle.

Press the START/PAUSE button to begin the countdown; the display will show the minutes left until the cycle starts.

After the countdown has begun, it can be stopped by pressing the ON/OFF button or by resetting the selected programme by turning the selector to the central position .

c) Delicate drying

This option is not enabled on all programmes. When this option is selected, only one branch of the heating element is activated, thus reducing power and consequently the drying temperature.

After selecting this option, the time shown on the display is updated automatically.

d) Time-controlled drying

Select the time-controlled programme on the selector dial in order to set the desired drying time by pressing the TIME button.

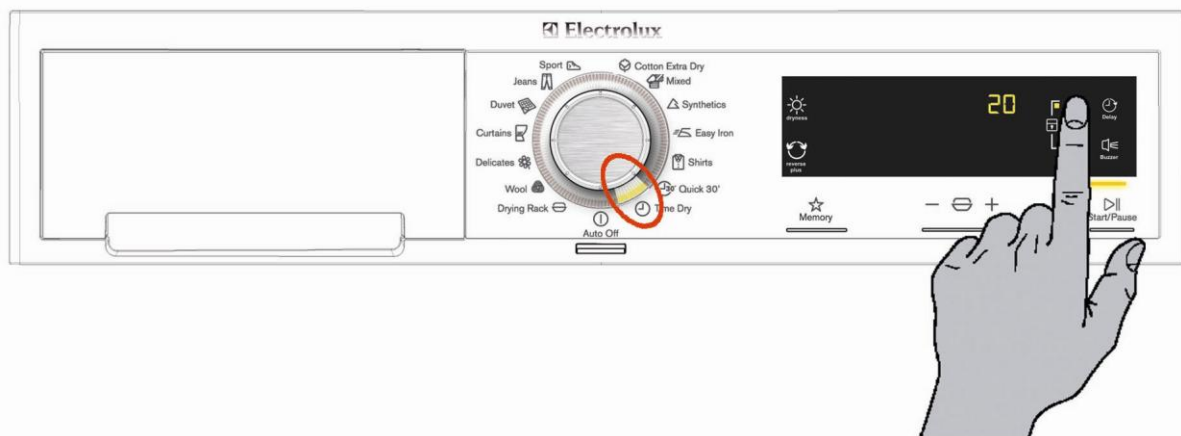

When the TIME button is pressed, the corresponding LED is lit and each time the button is pressed or if the button is held own, the time increases in 10-minute steps, from a minimum of 10 minutes to a maximum of 120 minutes (2 hours).

If you reach the maximum time, the next step resets the timer to 0 (zero).

e) Reverse plus

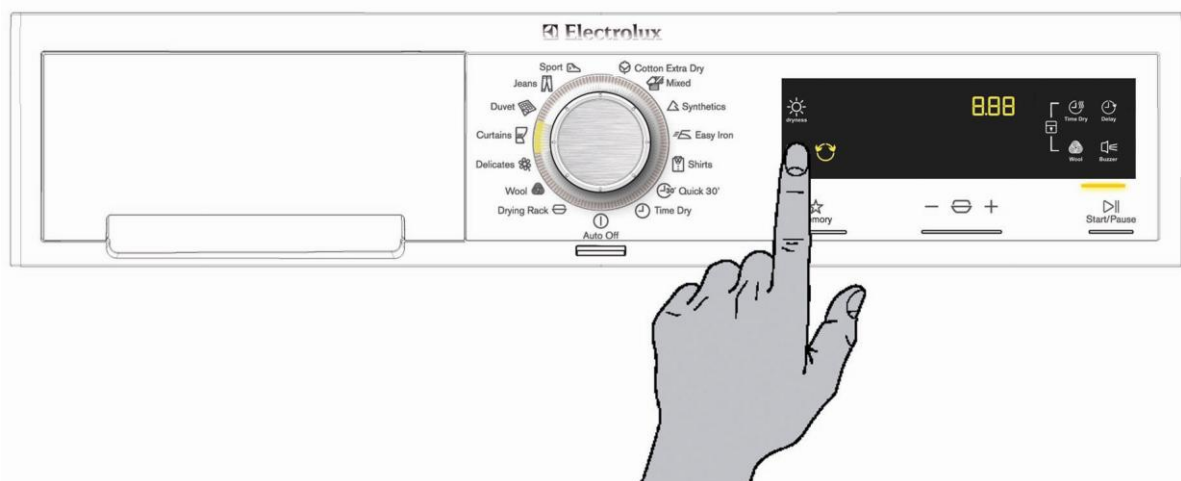

This option is only allowed on certain programmes.

By pressing the REVERSE PLUS key the corresponding icon comes on and the anti-clockwise basket movements increase. This ensures that the washing in the basket dries more evenly which is recommended especially in the synthetics programmes.

f) Degree of Drying

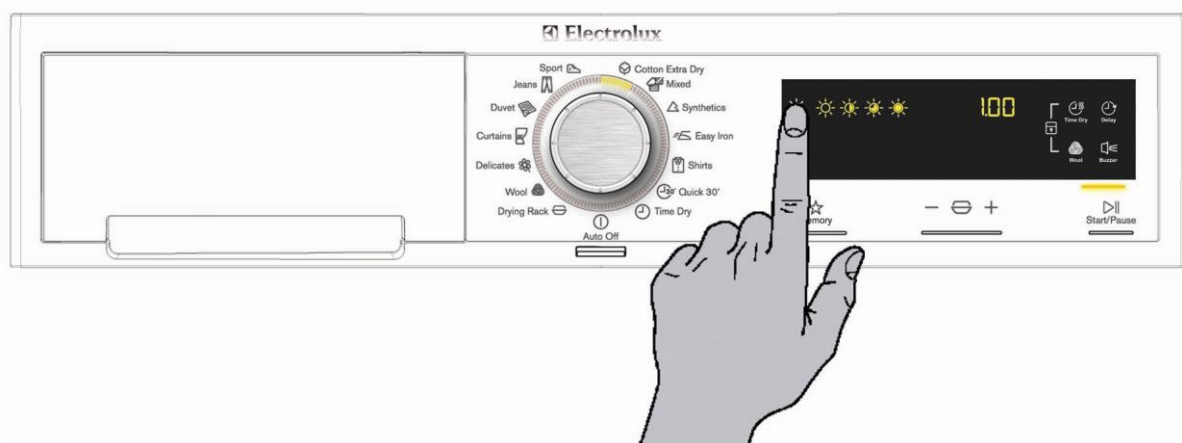

By using this push button we change the end level of dampness in the programmes, where it is available. By pressing the push button, you can select 4 different levels of drying shown on the display by 4 different symbols.



Iron dry



Wardrobe



Dry



Extra Dry

g) Drying with basket

By using the programme selector to select the drying with basket programme, we disable the humidity sensors.

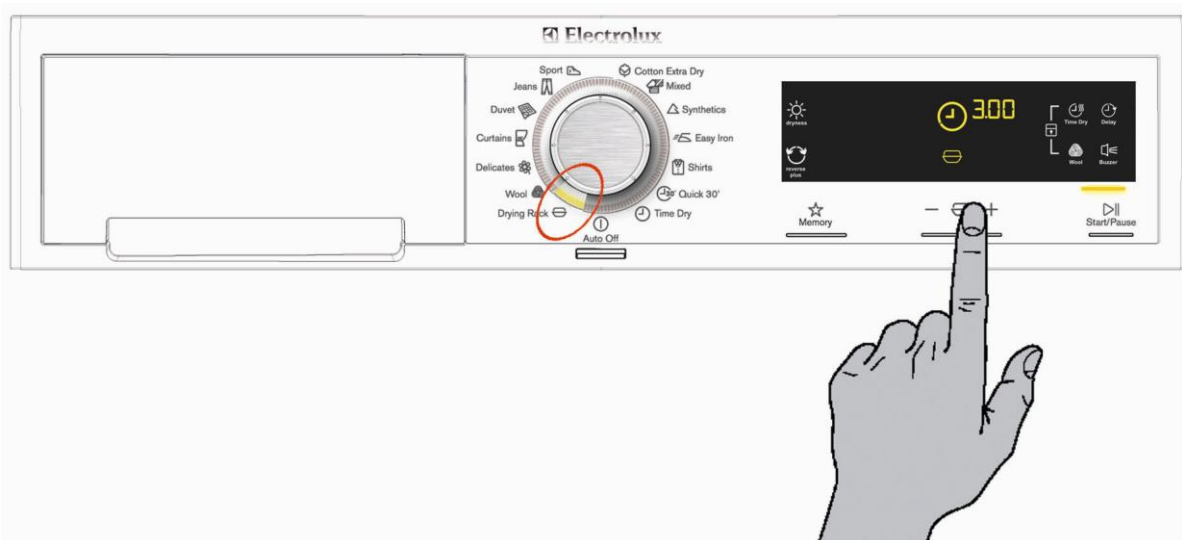

The rack symbol will appear on the display with a clock above while the digit will indicate the set drying time.

Using the two push buttons + and - located under the display we can set our own drying time; after pressing the start key the digit will begin the countdown until it reaches 000 irrespective of the dryness of the clothes in the basket.

4.3.4 Start/Pause

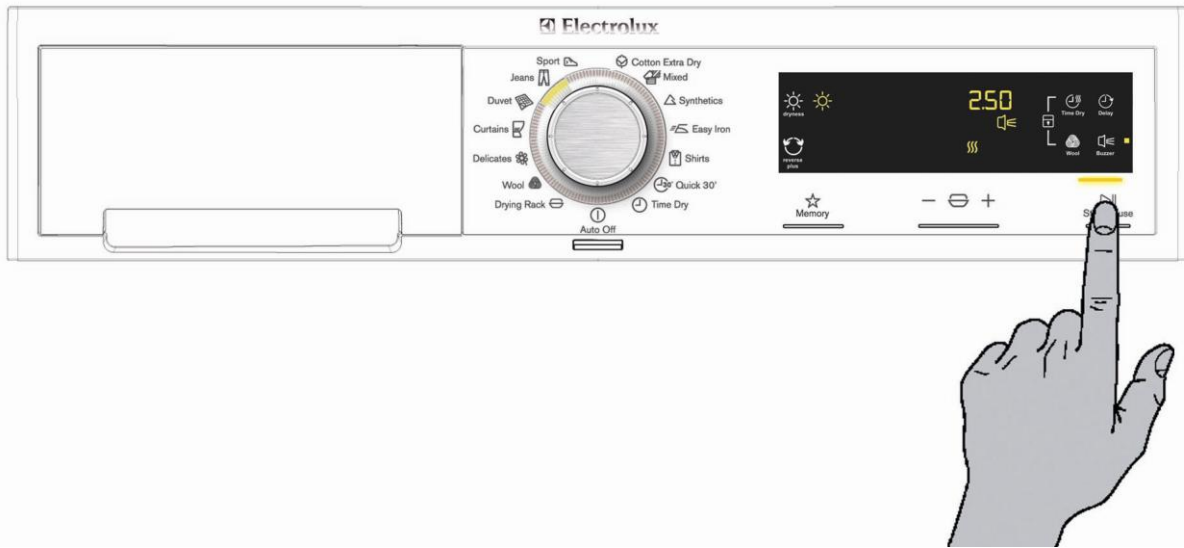

When a programme is selected and the appliance door is closed, simply press the Start/Pause button to start the cycle.

The corresponding LED will stop flashing and will remain lit permanently, the icon depicting the cycle phase in progress will begin to flash while the display updates the amount of time left accordingly.

Dry phase 

Cooling phase 

Anti-crease guard phase 

Should the door not be closed, the display will not show the time left until the end of the cycle but error "Err" and the LED will flash

After removing the error by closing the door, press Start/Pause again for the cycle to start up again.

Press the Start/Pause button during the cycle to pause the appliance.

When the appliance is on pause, you can add or remove options, but you cannot change the programmes; to do this, in this case, you need to turn off the tumble dryer at the On/Off button.

4.3.5 MEMORY Key

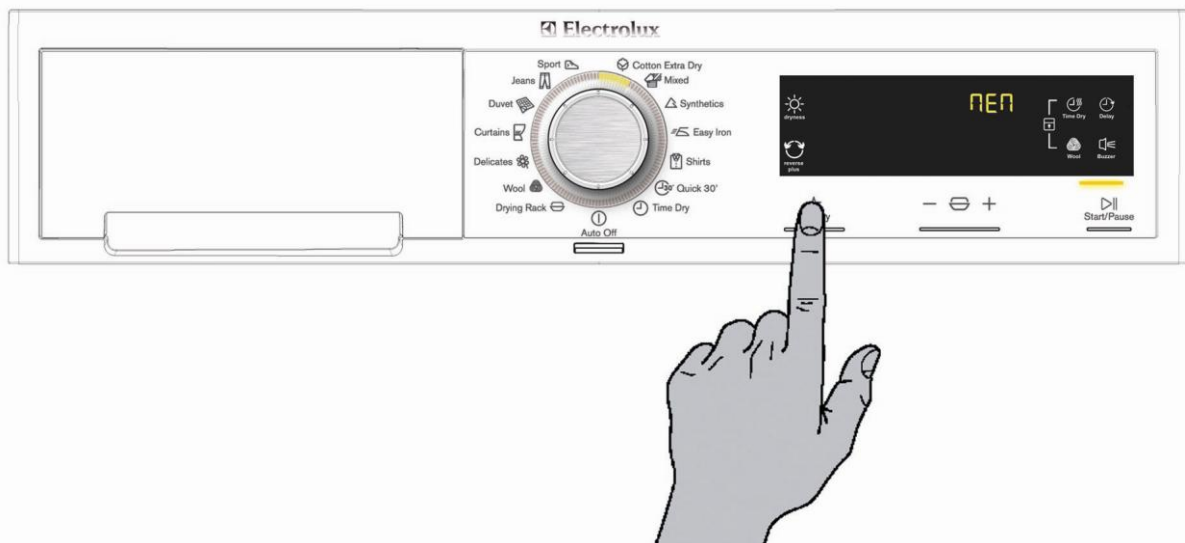

Thanks to this push button the user can store and recall a preferred programme.

Storing the programme

- Select the required programme.
- Insert any options.
- Keep the *Memory* key pressed down for more than 3 seconds and the flashing writing will appear on the display **MEM** while the buzzer emits a BEEP.



Storage can only be made before the cycle has started.

Recall the stored programme

- Just touch the *Memory* push button to recall the stored item from the memory and the tumble dryer programme and display with any options will set automatically.
- Press the Start/Pause push button to start the cycle.
- If no programme has been stored, the display and programme selector do not change their setting.

4.3.6 Key combinations

Some extra options or working modes can be selected via key combinations. The available functions and relative key combinations to be set are:

- Child lock.
 - Enable or disable buzzer.
 - Change water conductivity.
 - Demo Mode.
 - Disable water reservoir full alarm.
 - Diagnostics.
- **Child Lock**
Simultaneously press the keys indicated in the figure to set the child safety device and keep them pressed down until you hear a beep and the corresponding icon comes on .



This command blocks the user interface to prevent children from modifying the programme and keeps this function enabled even after the appliance has been turned off; once this option has been enabled, no further programme changes or option additions can be made.

To disable the child lock, press the above key combination again.

- **Enabling or disabling the buzzer**

Press the buttons indicated in the figure simultaneously to enable or disable the buzzer sounding permanently even after the appliance has been turned off or the programme has been changed.

When the alarm is enabled (default configuration), the LEDs associated with the key and icon  are lit.



- **Water conductivity**

The conductivity of the water used to wash the laundry varies from area to area; the conductivity sensor is set to a standard level, significant variations in conductivity level may have a negative effect on the final results of drying (laundry that is either too dry or still damp).

These variations can be noted particularly in “slightly damp” and “ready-to-iron” cycles; “wardrobe dry” cycles are practically never influenced by changes in conductivity.

To access the adjustment mode, turn on the tumble dryer at the ON/OFF button and simultaneously press the keys shown in the figure.



To change the conductivity value according to the table, press the **Start/Pause** button.

LCD	Conductivity level	Approximate value ($\mu\text{S}/\text{cm}$)
	LOW	< 300
	MEDIUM	300 – 600
	HIGH	> 600

The normal factory setting is medium level, but some models may have a different configuration.

Ask your local water supplier for details of the conductivity level of your water supply.

- **Demo mode**

The Demo mode is particularly used in showrooms to demonstrate to customers how the appliance works, by simulating the drying cycle.

In order to access demo mode turn on the tumble dryer at the ON/OFF button by rotating the programme selector clockwise by 3 positions and simultaneously pressing the keys shown in the figure.



Do this within 5 seconds after the tumble dryer has been turned on



The Demo mode remains enabled even after the tumble dryer has been turned off at the ON/OFF button. When the ON/OFF button is pressed to restart the appliance, the display will show DEM for a few seconds, to facilitate the use of the Demo function in a showroom.

To quit demo mode, disconnect the electricity supply to the tumble dryer.

- **Disable water reservoir full alarm**

Inserting this option disables or enables the warning at the end of the cycle  to remind you to empty the water tank.

This option should only be used if the water drain kit is installed.



If, for whatever reason, the water does not drain off and the condensation water collection tray fills up, the alarm rings anyway and blocks the drying cycle.

4.3.7 Warning Icons

There are three LEDs on the display    dedicated to showing warnings, to remind the user to perform specific operations.

- **Condenser**

It lights up at the end of the cycle only after approximately 100 hours of operation, to remind the user to clean the condenser at the bottom of the tumble dryer.



- **Condensation water tank**

It lights up at the end of every cycle to remind the user to empty the condensation water collection tank or during the actual cycle if it is full.

This warning can be disabled using the dedicated key combination if the water drain kit is fitted in the tumble dryer.



- **Filter or needle trap**

It lights up at the end of every cycle to remind the user to clean the fluff filter in the air conduit.



4.4 TC1

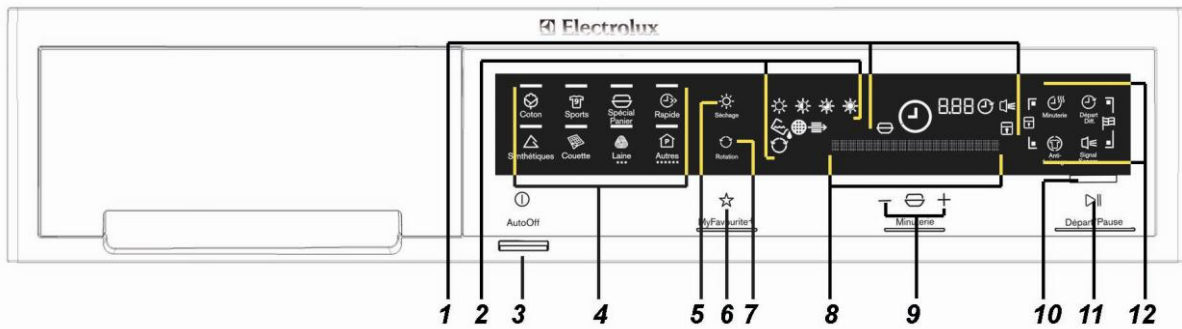

- | | |
|------------------------------------|-------------------------------------|
| 1. Digit and option icons | 7. Reverse plus |
| 2. Option and warning icons | 8. Digit-letter line |
| 3. ON/OFF button | 9. Basket time + or - |
| 4. Programmes | 10. Start/Pause LED |
| 5. Degree of Drying | 11. Start/Pause push button |
| 6. Preferred programme push button | 12. Functions leds and push buttons |

4.4.1 Programmes

This kind of appliance does not use a programme selector with knob but is fitted with 8 clear touch push buttons specifically for programme selection.

The programme labels are printed on the panel.

To select the programme just press directly on the required icon and respective LED indicator located above the lit icon.



The display will also provide text feedback of the selected programme.



The 2 touch sensor fields named on the right   underlined by 3 and 5 dots allow the user to access more than one programme.

By pressing these keys once the first programme on the list is selected, in order to access the other selectable programmes using these push buttons you need to press the push button again and the display will show which kind of programme we will be able to select.



The push button  allows you to select 3 programmes, while the push button  allows you to select 5 special programmes. The display shows the wording of the name of the programme currently selected.

4.4.2 ON/OFF button

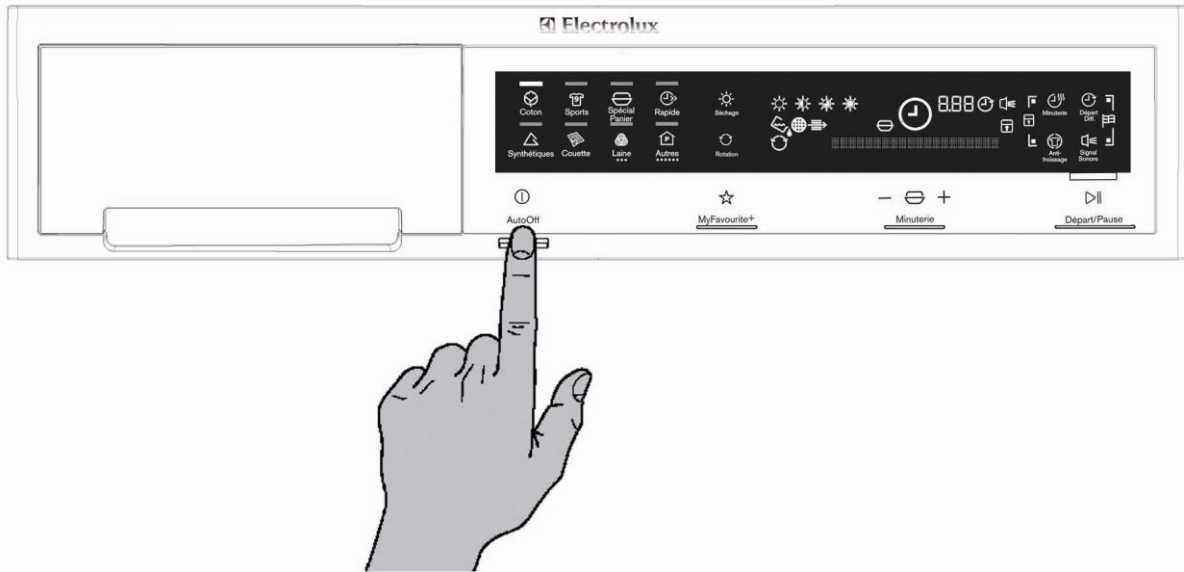

Press the **ON/OFF** key to turn on the appliance; the first programme in the top left is selected by default (except in specific cases, for example, if there is a power failure) the display shows the amount of time required for drying to be completed and the three icons corresponding to the drying, cooling, anti-crease phases are lit.

The time shown on the display should not be considered as a set time, since it is calculated according to a normal load with a given humidity, and obviously if the appliance load is lighter or the degree of humidity of the fabrics in the appliance is different, the time will change automatically and gradually as drying progresses.

4.4.3 Option buttons

The option buttons are used to change the selected programme according to personal requirements:

- a) Acoustic signal (buzzer).
- b) Delay Start.
- c) Delicate drying.
- d) Time-controlled drying.
- e) Reverse plus.
- f) Degree of drying.
- g) Drying with basket.



Press one or more buttons to enable or disable the relevant options.

When one or more options have been enabled, the related LEDs and icons are lit and if the options picked affect the cycle time, the display will automatically be updated.

a) Acoustic signal (buzzer)

This option enables or disables the buzzer sound permanently even after the machine is turned off or following a programme change.

When the alarm is enabled (default configuration), the LED associated with the key is lit.

b) Delayed Start

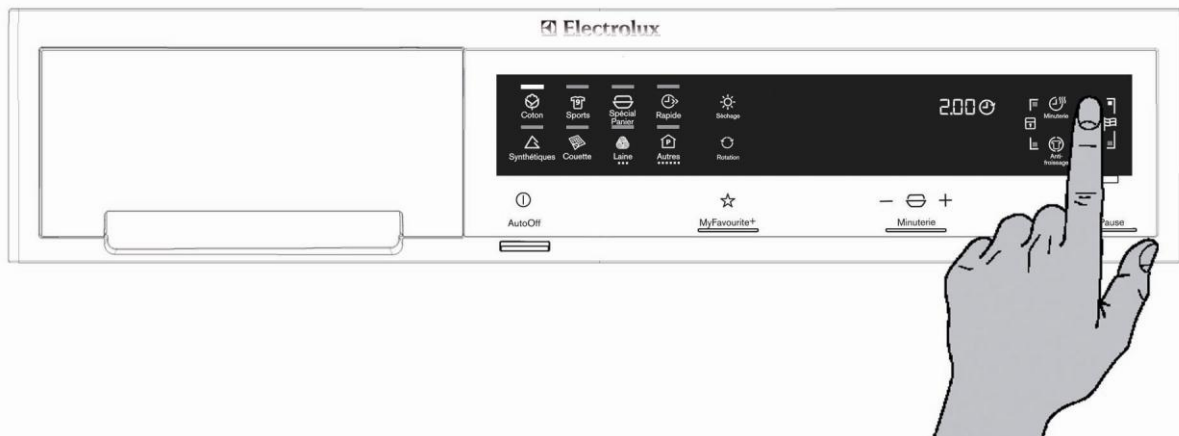

Press this button to postpone the selected programme start.

Once you have pressed this button, the related LED and icon  are lit and the display shows 30'.

To increase the time, press the button repeatedly or hold it down: the time will change in 30-minute steps for up to 90 minutes max, then the time will change in one-hour steps up to a maximum of 20 hours.

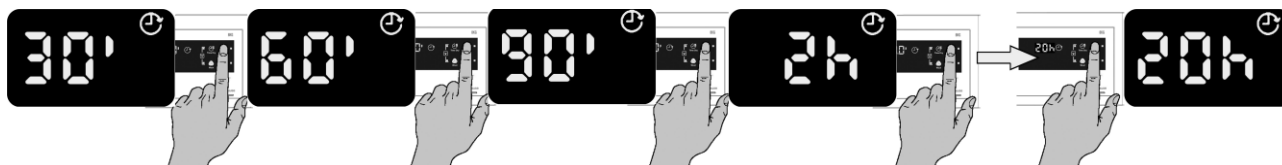

When a delayed start is set, the relevant LED is lit, and stays on for the entire duration of the cycle.

Press the START/PAUSE button to begin the countdown; the display will show the minutes left until the cycle starts.

After the countdown has begun, it can be stopped by pressing the ON/OFF button or by resetting the selected programme by turning the selector to the central position .

c) Delicate drying

This option is not enabled on all programmes. When this option is selected, only one branch of the heating element is activated, thus reducing power and consequently the drying temperature.

After selecting this option, the time shown on the display is updated automatically.

d) Time-controlled drying



Press the Other key several times and we can access the time controlled programme; the choice will appear on the display as TIME and the led to the side of the push button will come on.

After selecting the time controlled programme we can set our own drying time by pressing the TIME key, irrespective of the fabric's humidity control within the dryer.

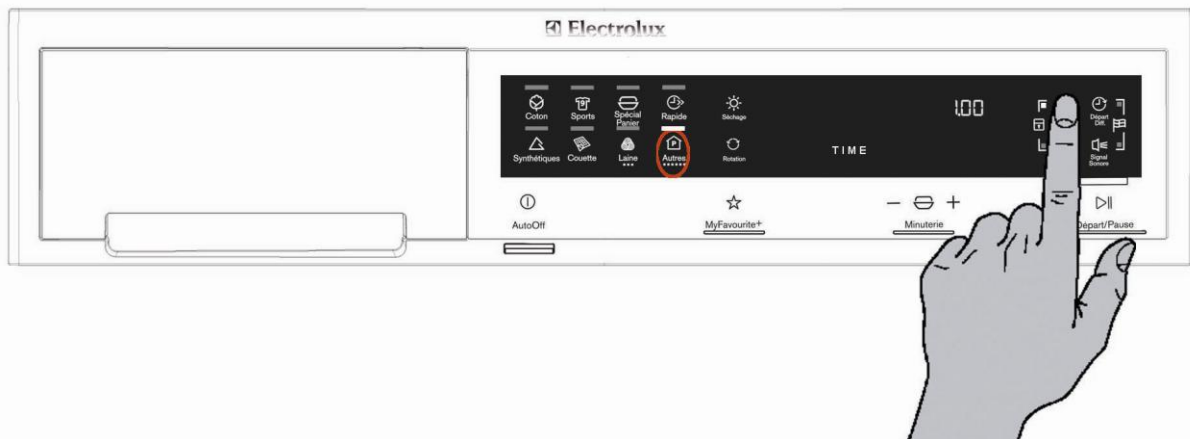

Each time the TIME key is pressed or by keeping it pressed down we can set the drying time to increase in 10 minute steps, from a minimum of 10 minutes to a maximum of 120 minutes (2 hours).

If you reach the maximum time, the next step resets the timer to 0 (zero).

e) Reverse plus

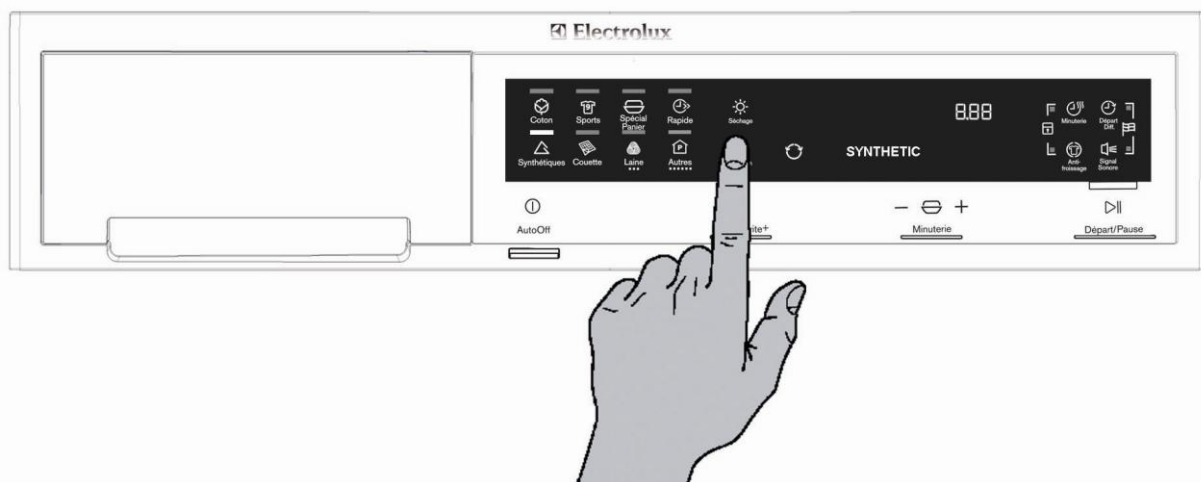

This option is only allowed on certain programmes.

By pressing the REVERSE PLUS key the corresponding icon comes on and the anti-clockwise basket movements increase. This ensures that the washing in the basket dries more evenly which is recommended especially in the synthetics programmes.

f) Degree of Drying

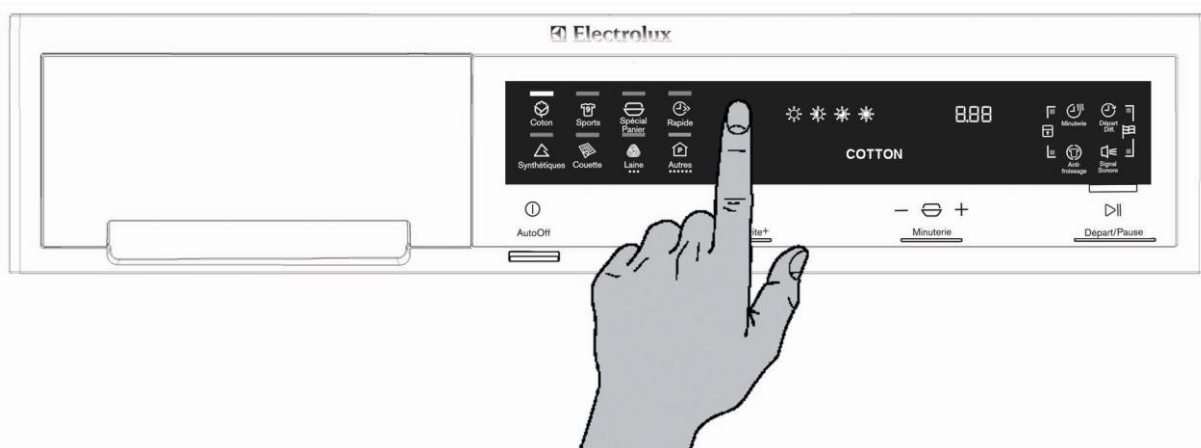

By using this push button we change the end level of dampness in the programmes, where it is available. By pressing the push button, you can select 4 different levels of drying shown on the display by 4 different symbols.



Iron dry



Wardrobe



Dry



Extra Dry

g) Drying with basket

By selecting the dryer with basket programme, we disable the humidity sensors.

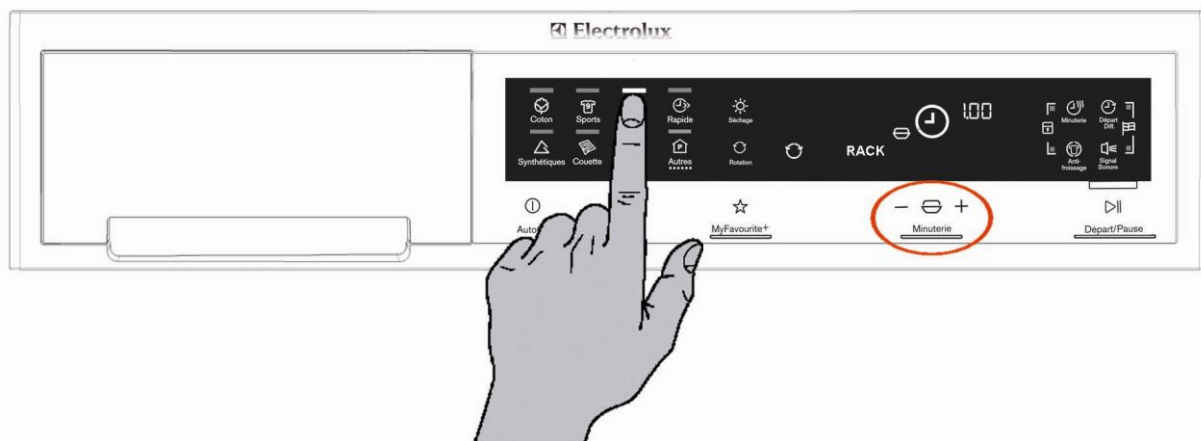

The rack symbol will appear on the display with a clock above while the digit will indicate the set drying time.

Using the two push buttons + and - located under the display we can set our own drying time; after pressing the start key the digit will begin the countdown until it reaches 000 irrespective of the dryness of the clothes in the basket.

4.4.4 Start/Pause

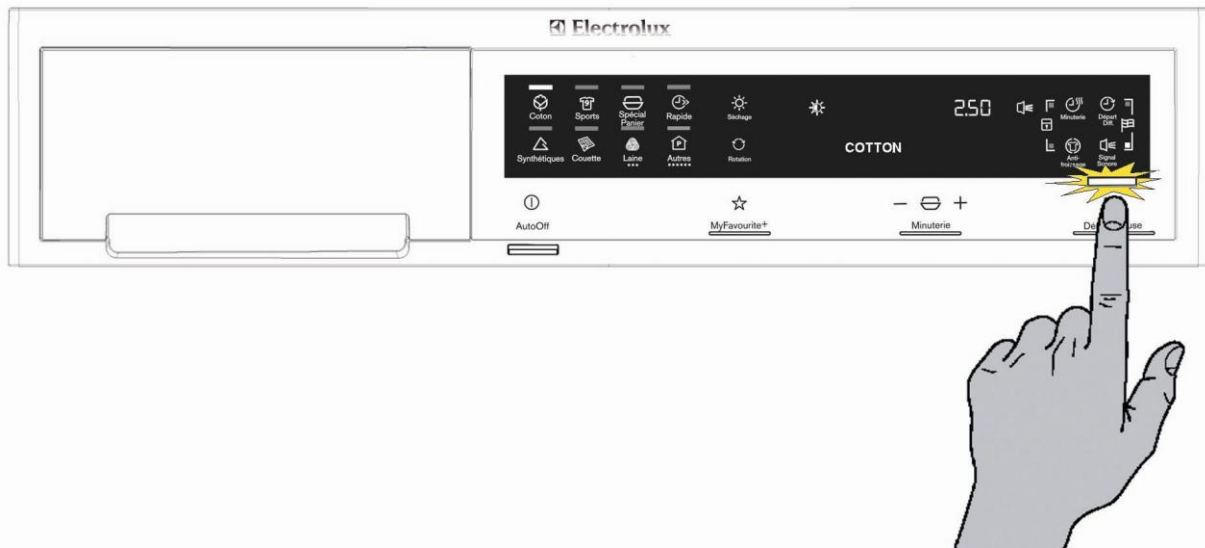

When a programme is selected and the appliance door is closed, simply press the START/PAUSE button to start the cycle.

The corresponding LED will stop flashing and will remain lit permanently, the display will show the work phase, while the display subsequently updates the remaining time.

Should the door not be closed, the display will no longer show the selected programme or the current work phase but will display the words "Door Open" and the LED will flash.

After removing the error by closing the door, press START/PAUSE again for the cycle to start up again.

Press the START/PAUSE key during the cycle to pause the appliance.

When the appliance is on pause, you can add or remove options, but you cannot change the programmes; to do this, in this case, you need to turn off the tumble dryer at the On/Off button.

4.4.5 MEMORY Key

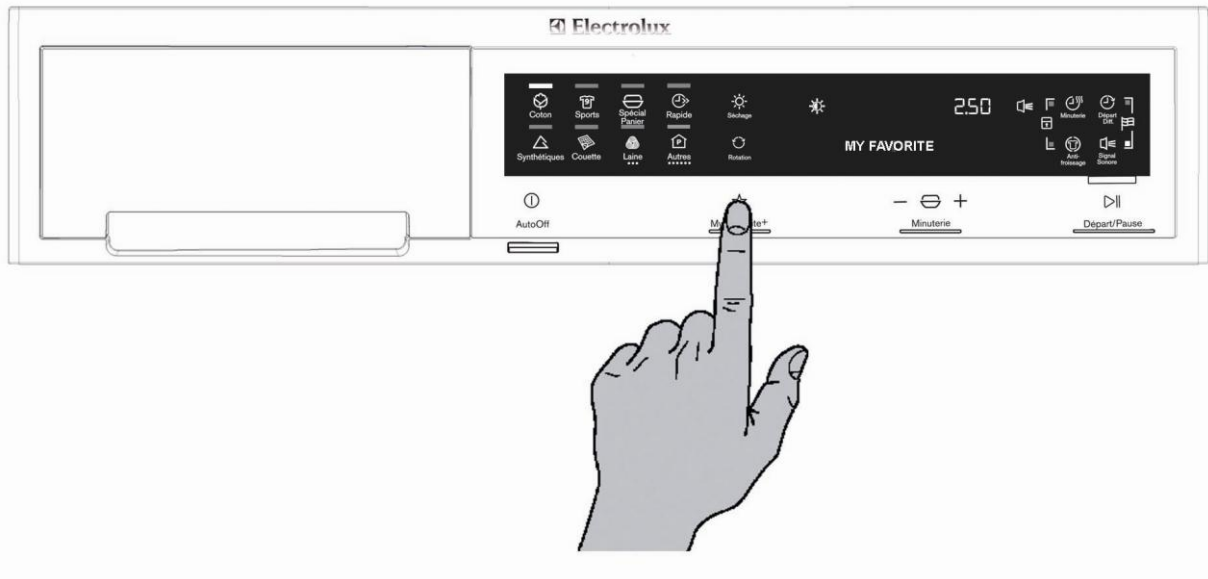

Thanks to this push button the user can store and recall a preferred programme.

Storing the programme

- Select the required programme.
- Insert any options.
- Keep the *Memory* key pressed down for more than 3 seconds and the flashing writing will appear on the display while the buzzer emits a BEEP



Storage can only be made before the cycle has started.

Recall the stored programme

- Just touch the *Memory* push button to recall the stored item from the memory and the tumble dryer programme and display with any options will set automatically.
- Press the Start/Pause push button to start the cycle.
- If no programme has been stored, the display and programme selector do not change their setting.

4.4.6 Key combinations

Some extra options or working modes can be selected via key combinations. The available functions and relative key combinations to be set are:

- Child lock.
 - Enable or disable buzzer.
 - Change water conductivity.
 - Demo mode.
 - Disable water reservoir full alarm.
 - Select language.
 - Diagnostics.
- **Child Lock**
Simultaneously press the keys indicated in the figure to set the child safety device and keep them pressed down until you hear a beep and the corresponding icon comes on .



This command blocks the user interface to prevent children from modifying the programme and keeps this function enabled even after the appliance has been turned off; once this option has been enabled, no further programme changes or option additions can be made.

To disable the child lock, press the above key combination again.

- **Enabling or disabling the buzzer**

Press the buttons indicated in the figure simultaneously to enable or disable the buzzer sounding permanently even after the appliance has been turned off or the programme has been changed.

When the alarm is enabled (default configuration), the LEDs associated with the key and icon  are lit.



- **Water conductivity**

The conductivity of the water used to wash the laundry varies from area to area; the conductivity sensor is set to a standard level, significant variations in conductivity level may have a negative effect on the final results of drying (laundry that is either too dry or still damp).

These variations can be noted particularly in “slightly damp” and “ready-to-iron” cycles; “wardrobe dry” cycles are practically never influenced by changes in conductivity.

To access the adjustment mode, turn on the tumble dryer at the ON/OFF button and simultaneously press the keys shown in the figure.



To change the conductivity value according to the table, press the **Start/Pause** button.

LCD	Conductivity level	Approximate value (µS/cm)
	LOW	< 300
	MEDIUM	300 – 600
	HIGH	> 600

The normal factory setting is medium level, but some models may have a different configuration.

Ask your local water supplier for details of the conductivity level of your water supply.

- **Demo mode**

The Demo mode is particularly used in showrooms to demonstrate to customers how the appliance works, by simulating the drying cycle.

Access demo mode by turning the dryer on at the ON/OFF push button and selecting the second programme in the top left, SPORT, and simultaneously pressing the keys shown in the figure.



Do this within 5 seconds after the tumble dryer has been turned on.



The Demo mode remains enabled even after the tumble dryer has been turned off at the ON/OFF button. When the ON/OFF button is pressed to restart the appliance, the display will show DEMO for a few seconds, to facilitate the use of the Demo function in a showroom.

To quit demo mode, disconnect the electricity supply to the tumble dryer.

- **Disable water reservoir full alarm**

Inserting this option disables or enables the warning at the end of the cycle  to remind you to empty the water tank.

This option should only be used if the water drain kit is installed.



If, for whatever reason, the water does not drain off and the condensation water collection tray fills up, the alarm rings anyway and blocks the drying cycle.

- **Select language**

This function is used when installing the appliance and each time you leave the diagnostics function.



If no key is pressed within 15 seconds or the appliance turns off before selecting a language, the user interface leaves the selection mode displaying the information in the preferred language.

If no language is selected the next time the appliance is turned on, it will once again request for a language to be selected.

By entering language setting mode, the pre-defined language configured in the factory which corresponds to the language in the control panel screen, appears in the text line.

After about 3 seconds, a help message appears that invites the client to press the keys + or - to select the language.

After another 3 seconds a second help message appears that invites the client to press Start/Pause to confirm the language selection

If an incorrect language has been selected or if you wish to change the language, simultaneously press the keys indicated in the figure and proceed as above.

- **Diagnostics**

The diagnostics process is designed to check all the components in the tumble dryer.

To enter diagnostics mode, proceed as follows:

Turn on the tumble dryer at the ON/OFF button. Wait for the LEDs to be lit and for the buzzer to BEEP (if the alarm is not disabled).

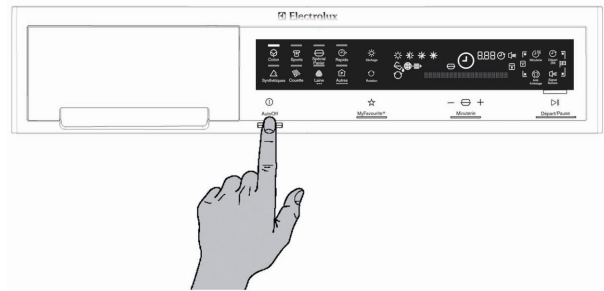

Press the keys shown in the figure simultaneously.



This must be done within 5 seconds after the tumble dryer has been turned on!

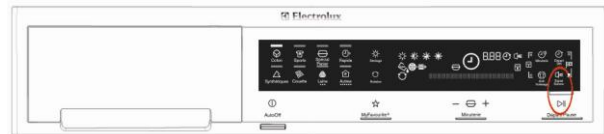

- **Quitting diagnostics mode**

To quit diagnostics mode, turn the tumble dryer off at the ON/OFF button, then turn it back on in order to reset it. The display shows **ELE** then turn it back off.

- **Selector dial positions in diagnostics**

See the paragraph which applies to all stylings "SELECTOR DIAL POSITION IN DIAGNOSTICS".

4.4.7 Warning Icons

There are three LEDs on the display    dedicated to showing warnings, to remind the user to perform specific operations.

- **Condenser**

It lights up at the end of the cycle only after approximately 100 hours of operation, to remind the user to clean the condenser at the bottom of the tumble dryer.



- **Condensation water tank**

It lights up at the end of every cycle to remind the user to empty the condensation water collection tank or during the actual cycle if it is full.

This warning can be disabled using the dedicated key combination if the water drain kit is fitted in the tumble dryer.



- **Filter or needle trap**

It lights up at the end of every cycle to remind the user to clean the fluff filter in the air conduit.

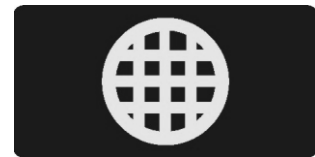

5 Selector dial positions in diagnostics



The alarms are enabled during diagnostic testing of components. If an alarm appears, move the selector to the first position to exit the alarm status and, if necessary, continue the test (if the alarm is not triggered again).

To check the correct functioning of the float switch and pump, the trap should be filled with approximately 0.7 litres of water.

In order to test the conductivity sensor properly in case of a short-circuit (position 8), a short circuit must be created between the two sensors on the front air conduit before moving the selector dial to the eighth position. If the short-circuit is not created properly, the circuit board will display alarm E32 (sensor frequency too low). To exit this alarm, move the selector to the first position.

In the TC1 models with no selector press touchkey **A** to move on to the next test or press pushbutton **B** to return to the previous test.

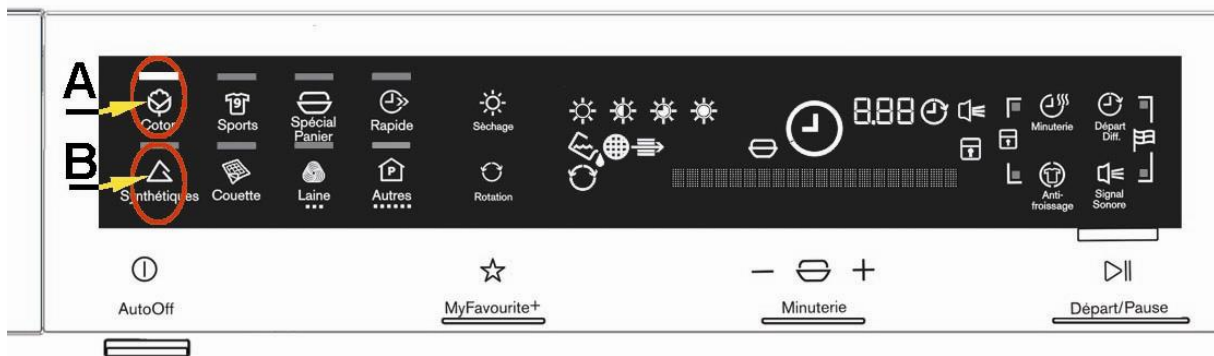

Position 1

User interface test	Purpose of the test:	To test the functionality of all LEDs and switches.
	Components activated:	All LEDs. LCD display.
	Behaviour:	All LEDs flash in sequence. Press a button and the corresponding LED is lit; the code is shown on the LCD display and the buzzer sounds. All LCD icons flash simultaneously.
	Working conditions:	There is a control to run the test (always active).

Position 2

Float micro-switch and condensation water pump



Purpose of the test:	To test the pump and micro-switch situated in the condensation water tray.
Components activated:	If the condensation water collection tray is full and the micro-switch detects this condition, the pump is started.
Behaviour:	If the water level in the tray is low, the LCD displays III and if the level is high (micro-switch triggered), the LCD displays 000.
Working conditions:	Door closed (time out 10 secs.).

Position 3

Counter Clockwise drum rotation



Purpose of the test:	To test the drum rotation motor in an anti-clockwise direction.
Components activated:	Motor TRIAC. Anti-clockwise direction relay. Drum rotation motor. Condensation water filling pump.
Behaviour:	The motor turns the drum anti-clockwise and the condensation water filling pump is in operation.
Working conditions:	Door closed (time out 10 mins.).

Position 4

Clockwise drum rotation



Purpose of the test:	To test the drum rotation motor in a clockwise direction.
Components activated:	Motor TRIAC. Clockwise direction relay. Drum rotation motor.
Behaviour:	Phase LEDs are switched ON.
Working conditions:	Door closed (time out 10 mins.).

Position 5

Heater ½ power
Clockwise drum rotation



Purpose of the test:	To test a part of the heating element (half power).
Components activated:	Top Heating Element. Clockwise drum rotation motor.
Behaviour:	The drying temperature NTC1 is displayed on the LCD. Phase icons are lit.
Working conditions:	Door closed (time out 10 secs.).

Position 6

Heater full power
Clockwise drum rotation



Purpose of the test:	To test the heating element on full power (both branches powered).
Components activated:	Both the top heating elements. Clockwise drum rotation motor.
Behaviour:	The drying temperature NTC1 is displayed on the LCD. Phase icons are lit.
Working conditions:	Door closed (time out 10 secs.).

Position 7

Open-circuited conductivity sensor



Purpose of the test:	To check the conductivity sensor in open-circuit conditions.
Components activated:	Conductivity sensor.
Behaviour:	The test lasts 4 seconds, during which the LCD flashes, displaying 000. At the end of the test, the LCD stops flashing and displays III. If the test was unsuccessful, the LCD continues to flash, displaying.
Working conditions:	Conductivity sensor free from any garments or contact.

Position 8

Closed circuited conductivity sensor



Purpose of the test:	To verify conductivity sensor in short circuit condition.
Components activated:	Conductivity sensor.
Behaviour:	The test lasts 4 seconds, during which the LCD flashes, displaying 000. At the end of the test, the LCD stops flashing and displays III. If the test is unsuccessful, the LCD displays the alarm E32.
Working conditions:	Short-circuited conductivity sensor.
	Create a short circuit between the two sensors on the front air conduit before setting the selector dial to the eighth position.

Position 9

Condenser Tank Switch	Purpose of the test:	To test the micro-switch under the condensation water collection tray.
	Components activated:	If the condensation water collection tray is full and the micro-switch detects this condition, the pump is started.
	Behaviour:	If the water level in the tray is low, the LCD displays III and if the level is high (micro-switch triggered), the LCD displays 000.
	Working conditions:	Door closed (time out 10 secs.).

Position 10

Last alarm display and possible reset	Purpose of the test:	To see the alarm and delete it.
	Behaviour:	The LCD display flashes and shows any alarm present.
	Working conditions:	Turn the dial to position 10, paying attention not to stop in position 8 in order to avoid error 32. Press the START/PAUSE button to see all the alarms present. To delete the alarms, hold down the START/PAUSE buttons and press the button on the left.

Position 11 and subsequent positions

	Behaviour:	All LEDs flash in sequence. Press a button and the corresponding LED is lit; the code is shown on the LCD display and the buzzer sounds.
	Working conditions:	Door closed (time out 10 secs.).

6 Alarms

Operation of the alarms is configurable according to the model. Some or all of the alarms may be displayed to the user.

When an alarm condition occurs, the drying cycle may be interrupted or paused; in some cases, for safety reasons, a forced cooling cycle is performed.

In this case, the electronic board, if possible, disconnects the power relay from the heating element and powers the drum rotation motor with cooling fan. The cycle remains active until the user switches off the appliance.

6.1 Alarm display during normal operation

On models with LCD the system displays the family of the current alarm to the user.

- First digit: letter “E”.
- Second digit: the family of the alarm.
- Third digit: the alarm number.

If we consider, for example, the alarm E53 (communication error between the motor control board and the main board), the following will be displayed:

- First digit: letter “E” (error).
- Second-third digit: the number “5 0”, i.e. the family of the alarm E53).

6.2 Reading the alarms

To read the last alarm code stored, proceed as follows:

- ⇒ Access diagnostics mode (see paragraph).
- ⇒ Turn the programme selector dial clockwise to the tenth position and the display will show the last code stored.
- ⇒ To display any other alarms, press the START/PAUSE button.



*Try not to stop on position 8, otherwise a dummy alarm is triggered!
Alarm 32*

- First digit: letter “E”.
- Second digit: the family of the alarm.
- Third digit: the alarm number.

The configuration errors E93 are displayed through the flashing of all LEDs and it is not possible to access the diagnostics system.

6.3 Cancelling the last alarm memorised

It is good practice to cancel the alarm code from the memory:

- After reading the alarm, to check whether it is repeated during the diagnostics cycle.
 - After effecting repairs to the appliance, to check whether it is repeated during testing.
1. Start diagnostics mode.
 2. Turn the programme selector in a clockwise direction to position ten.
 3. Press the Start/Pause button and the button immediately to the left of it simultaneously.
 4. Hold the buttons down for approximately 5 seconds.
 5. After deleting, E00 will be displayed.

6.4 Notes about specific alarm codes

- **Configuration alarm E93:**

When configuration alarms are displayed (when the appliance is switched on), the appliance is inoperative and all the LEDs light. It is not possible to access diagnostics; the only operation possible is to switch off the appliance (selector knob on position "0").

- **Alarms EH1-EH2-EH3:**

In the event of problems with the power supply, the appliance remains in alarm mode until the voltage and frequency are restored to within the normal limits or the appliance is switched off. Alarm family "H" is displayed and it is not possible to access diagnostic mode nor to use the "rapid alarm display" function.

The complete alarm can be read only when the abnormal condition has terminated.

6.5 ALARMS TABLE

FAMILY		ALARM CODE	Full name	Action	Notes and possible causes
Ex20	CONDENSATION WATER FILLING PUMP	Ex21	Condensation water filling pump alarm	<ul style="list-style-type: none"> The cycle is suspended. If detected during configuration, the cycle start will not be permitted. 	<ul style="list-style-type: none"> Pump disconnected (wiring or connector error). Pump faulty. Water filling pump TRIAC error (short-circuit, diode mode, open circuit) (power board error).
		Ex22	Condensation water filling pump detection alarm	<ul style="list-style-type: none"> The cycle is suspended. If it is detected before the cycle starts, the cycle start will not be permitted. 	<ul style="list-style-type: none"> Pump TRIAC detection circuit error (main board error).
Ex30	CONDUCTIVITY SENSOR	Ex31	Conductivity Sensor Frequency too HIGH	<ul style="list-style-type: none"> No action. 	<p>Only active during diagnostics of the HUMIDITY SENSOR SHORT-CIRCUIT.</p> <ul style="list-style-type: none"> The oscillation Frequency is out of Range (main board failure).
		Ex32	Conductivity Sensor Frequency too LOW	<ul style="list-style-type: none"> No action. 	<p>Only active during diagnostics of the HUMIDITY SENSOR SHORT-CIRCUIT.</p> <ul style="list-style-type: none"> The drum is not short-circuited. Wiring error. The oscillation Frequency is out of Range (main board failure).
Ex40	DOOR	Ex45	Door Closed Sensing Alarm	<ul style="list-style-type: none"> The cycle is suspended. If it is detected before the cycle starts, the cycle start will not be permitted. 	<p>Error in the door closed detection circuit.</p> <ul style="list-style-type: none"> Door micro-switch faulty or disconnected. Main board error.

FAMILY		ALARM CODE	Full name	Action	Notes and possible causes
E0x50	DRUM ROTATION MOTOR	Ex51	Motor power triac short-circuited	<ul style="list-style-type: none"> The cycle is suspended. If it is detected before the cycle starts, the cycle start will not be permitted. 	<ul style="list-style-type: none"> Motor faulty. Faulty wiring. Main circuit board faulty.
		Ex52	Motor thermal cut-out triggered	<ul style="list-style-type: none"> The cycle is suspended. If it is detected before the cycle starts, the cycle start will not be permitted. 	<ul style="list-style-type: none"> Motor faulty. Motor thermal cut-out has triggered. Faulty wiring. Main circuit board faulty.
		Ex53	Motor TRIAC "sensing" circuit faulty	<ul style="list-style-type: none"> The cycle is suspended. If it is detected before the cycle starts, the cycle start will not be permitted. 	<ul style="list-style-type: none"> Main circuit board faulty.
		Ex54	Motor blocked	<ul style="list-style-type: none"> The cycle is suspended. If it is detected before the cycle starts, the cycle start will not be permitted. 	<ul style="list-style-type: none"> Washing load is too large. Power supply voltage low. Motor/drive system blocked.
Ex60	HEATING ELEMENTS	Ex62	Short-circuited heating element	<ul style="list-style-type: none"> The drying cycle is suspended and to prevent fires, a 10-minute cooling cycle is automatically started. If it is detected before the cycle starts, the cycle start will not be permitted. 	<ul style="list-style-type: none"> Short-circuited heating element. Heating element earth contact. Faulty wiring. Main circuit board faulty.
		Ex63	Heating element alarm triggered	<ul style="list-style-type: none"> It disables the heating element for a given period of time, while waiting for the temperature to stabilise, if necessary. If normal operating conditions are not restored within approximately 30 minutes, alarm 0x62 is triggered. 	<ul style="list-style-type: none"> Heating element disconnected (wiring or connector failure, manual thermostat cut-off). Heating element faulty. Fan motor has stopped. Relay error (main board faulty).
		Ex64	Heating element "sensing" circuit faulty	<ul style="list-style-type: none"> The cycle is suspended. If it is detected before the cycle starts, the cycle start will not be permitted. 	<ul style="list-style-type: none"> Error in the heating element detection circuit. Main board faulty.

FAMILY		ALARM CODE	Full name	Action	Notes and possible causes
0x70	NTC	Ex71	Drying NTC alarm	<ul style="list-style-type: none"> The cycle is suspended. If it is detected before the cycle starts, the cycle start will not be permitted. 	NTC1 reading out of range. <ul style="list-style-type: none"> Wiring Failure. NTC Failure. NTC reading circuit error (main board error).
		Ex72	Heating element NTC alarm	<ul style="list-style-type: none"> The cycle is suspended. If it is detected before the cycle starts, the cycle start will not be permitted. 	NTC2 reading out of Range <ul style="list-style-type: none"> Wiring Failure. NTC Failure. NTC reading circuit error (main board error).
0x80	IU	Ex83	Incorrect selector dial position	<ul style="list-style-type: none"> No action. 	<ul style="list-style-type: none"> The code for the selector position is not recognised. Selector faulty (main board error).
		Ex86	Incorrect selector configuration	<ul style="list-style-type: none"> No action. 	<ul style="list-style-type: none"> Incorrect Selector Configuration (main board failure). Selector faulty (main board error).

FAMILY		ALARM CODE	Full name	Action	Notes and possible causes
Ex90	CFG	Ex91	User interface board communication alarm	<ul style="list-style-type: none"> ▪ No action possible. 	<ul style="list-style-type: none"> ▪ Faulty wiring. ▪ User interface board faulty. ▪ Main board faulty.
		Ex91	Inconsistent user interface board protocol	<ul style="list-style-type: none"> ▪ No action possible. 	<ul style="list-style-type: none"> ▪ The User Interface board is not compatible with the Main Board.
		Ex93	MCF checksum alarm	<ul style="list-style-type: none"> ▪ The machine could not work until a right configuration file is programmed. 	<ul style="list-style-type: none"> ▪ Wrong Machine Configuration File.
		Ex94	CCF checksum alarm	<ul style="list-style-type: none"> ▪ The machine could not work until a right configuration file is programmed. 	<ul style="list-style-type: none"> ▪ Wrong Cycle Configuration File.
		Ex97	Missing programme on CTF alarm	<ul style="list-style-type: none"> ▪ Only detected when configuration is performed. ▪ Does not allow the cycle to start. 	<ul style="list-style-type: none"> ▪ Wrong selector configuration (MCF) or missing cycle on cycle table (CCF).
		Ex9C	User interface checksum alarm	<ul style="list-style-type: none"> ▪ No action possible. 	

FAMILY		ALARM CODE	Full name	Action	Notes and possible causes
ExB0 (ExH0)	POWER SUPPLY	ExB1 ExH1	Power supply frequency out of range	<ul style="list-style-type: none"> If detected in setup, it would not be possible cycle starting. If happens during cycle execution, it suspend working. It is automatically cleared when power supply return within right limits, it would be possible to start. If a cycle was temporary suspended due to this alarm it automatically restarts. 	<ul style="list-style-type: none"> Power Supply Problems. Wrong MCF. Main board error.
		ExB2 ExH2	Power supply voltage out of range (too HIGH)		<ul style="list-style-type: none"> Power Supply Problems - Too HIGH VOLTAGE. Wrong MCF. Main board error.
		ExB3 ExH3	Power supply voltage out of range (too LOW)		<ul style="list-style-type: none"> Power Supply Problems - TOO LOW VOLTAGE. Wrong MCF. Main board error.
		ExB4 ExH4	Zero Watt relay alarm	<ul style="list-style-type: none"> The tumble dryer is working properly but the zero watt circuit is never activated. 	<ul style="list-style-type: none"> Main board faulty.
		ExBD ExHD	Current leakage alarm	<ul style="list-style-type: none"> The cycle is suspended. 	<ul style="list-style-type: none"> Current leakage of any actuator. Faulty wiring. Main board faulty.
		ExBE ExHE	Safety line alarm	<ul style="list-style-type: none"> The cycle is suspended. 	<ul style="list-style-type: none"> Main board faulty.
		ExBF ExHF	Safety line sensing alarm	<ul style="list-style-type: none"> The cycle is suspended. 	<ul style="list-style-type: none"> Main board faulty.
		ALARMS		ExF6	Microprocessor safety reset

7 Revisions

Revision	Date	Description	Author	Approved by – on
00	05/2012	Document creation	A.D.L.	A.D.L. – 05/2012