



©ELECTROLUX HOME PRODUCTS  
Customer Care - EMEA  
Training and Operations Support  
Technical Support

Publication  
number

**599 74 96-55**

EN

Edition: 04/2011 - Rev. 00



INDEX.

1	Control panel .....	4
2	How to remove the handle.....	5
3	How to remove the gasket.....	6
4	How to remove the thermostat .....	7
5	How to remove the control panel.....	8
6	Electrical diagram .....	9
7	Troubleshooting for non-operation of compressor .....	10

# 1 Control panel

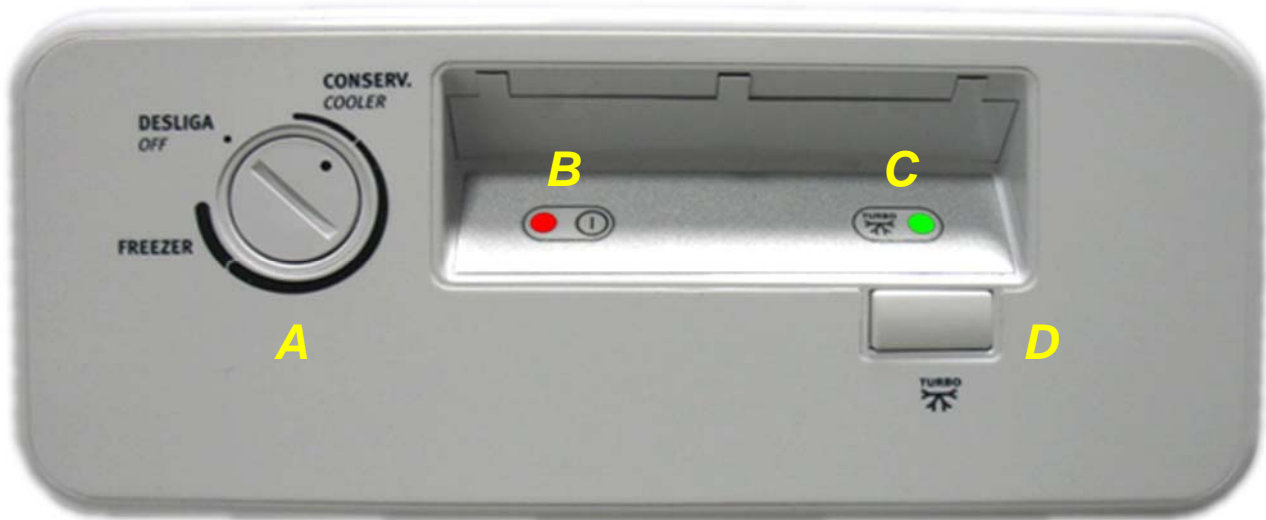

- A** Dual control (freezer and cooler)
- B** Supply lamp (red)
- C** Super freezer lamp (green)
- D** Super freezer switch

## 2 How to remove the handle

- Insert a screwdriver in the hole.
- Unlock the clip.

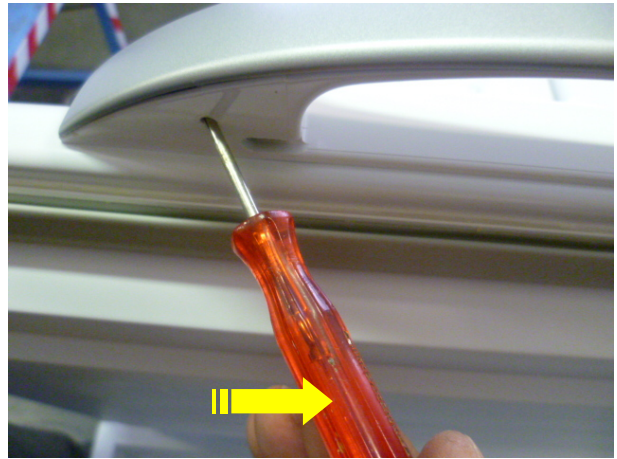

- Push up the handle cover.

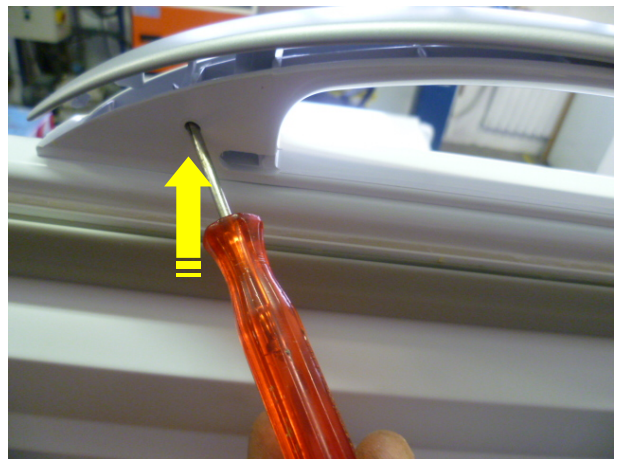

- Repeat the same operation in the pther side of the handle
- Remove the handle cover.



- Unscrew the 2 screws and remove the handle.



### 3 How to remove the gasket

- Open lid



- pull the gasket as shown in figure and remove it completely

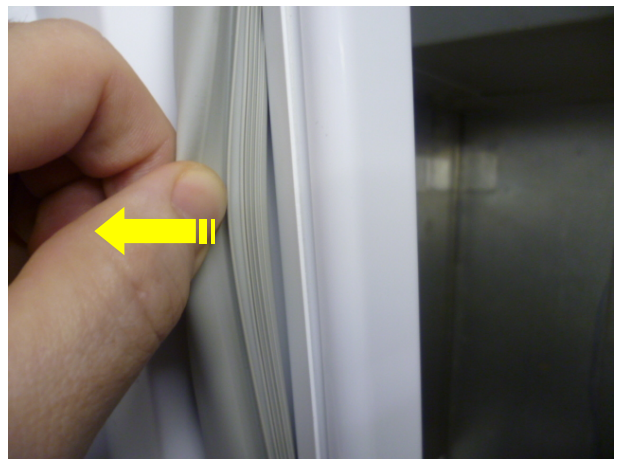

## 4 How to remove the thermostat

- Open the right panel.
- Insert a screwdriver in the hole.

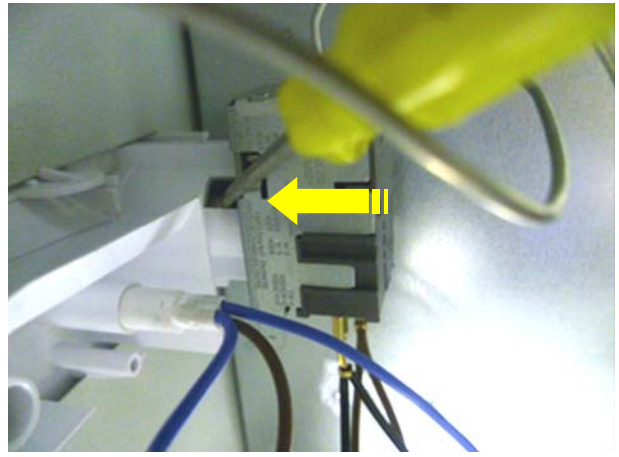

- Push out the knob like in picture.



- In the bottom of the hole is located a nut



- Unscrew the nut and remove the thermostat.



## 5 How to remove the control panel

- Using a screwdriver push the 3 clip in the top and the 3 clip in the bottom like in picture.

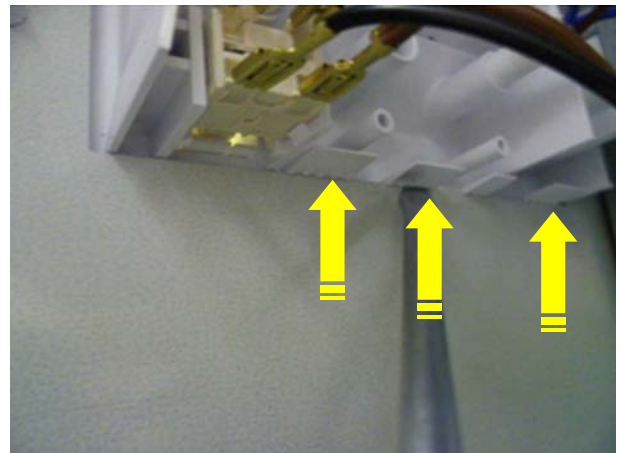
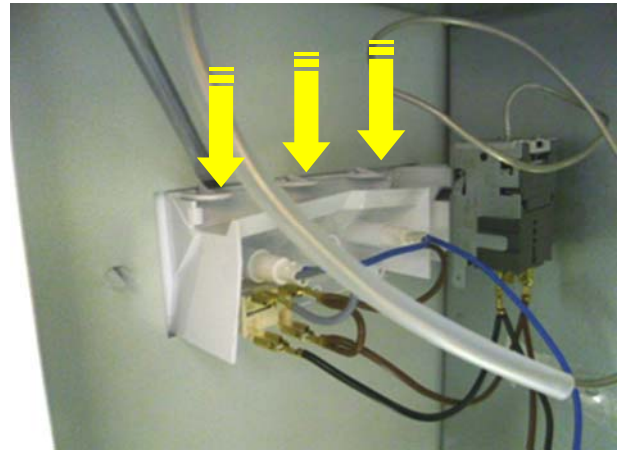

- After unlocked the 6 clip press the pin that fix the control panel using a nipper and remove the complete control panel.

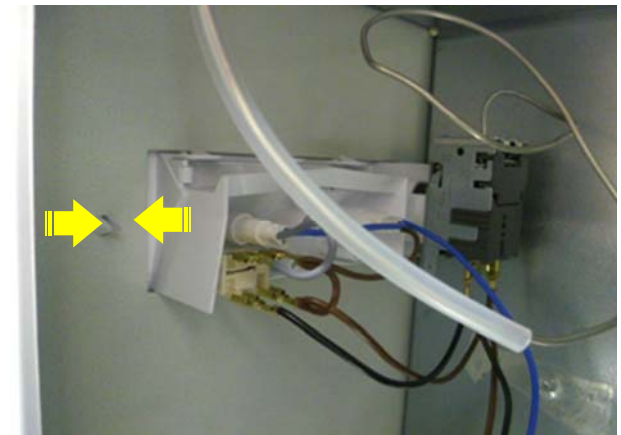
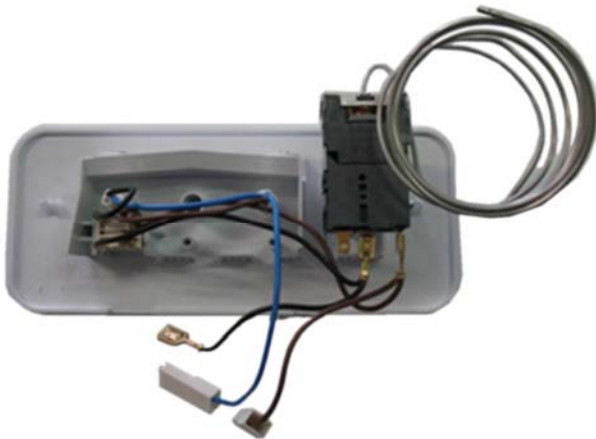



# 6 Electrical diagram

2128218 - 01

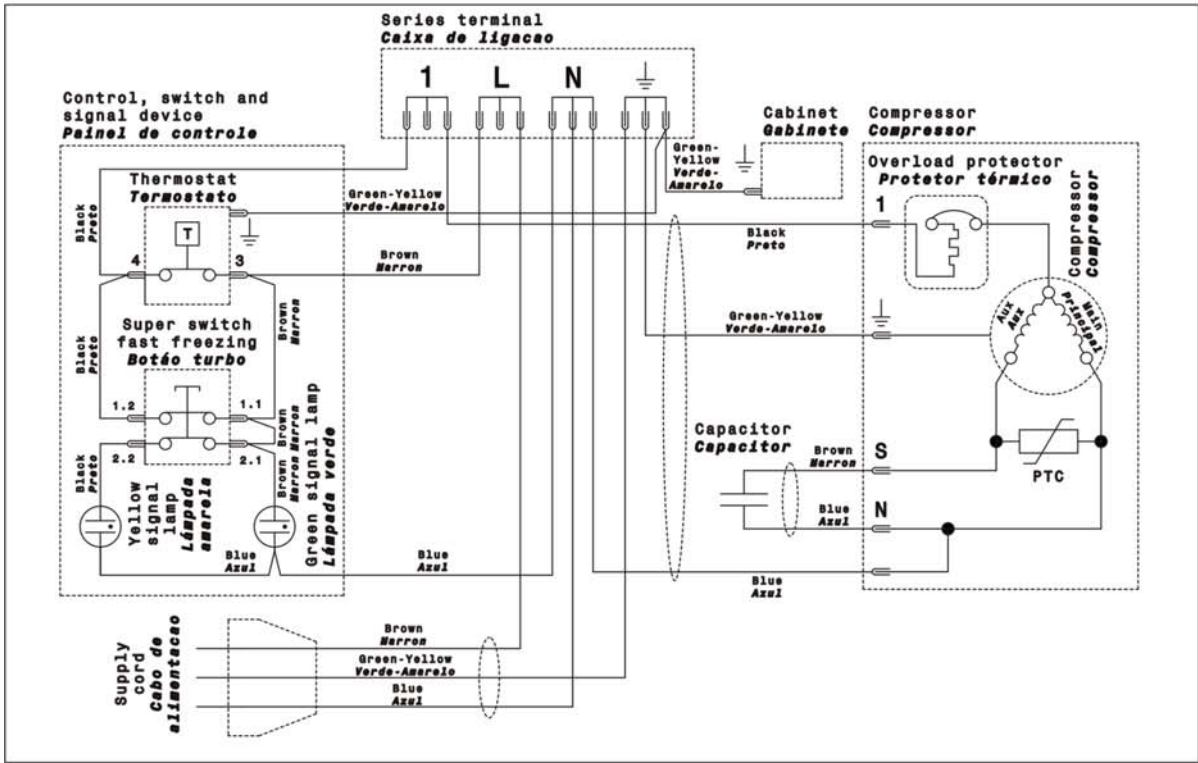

2128218 - 02

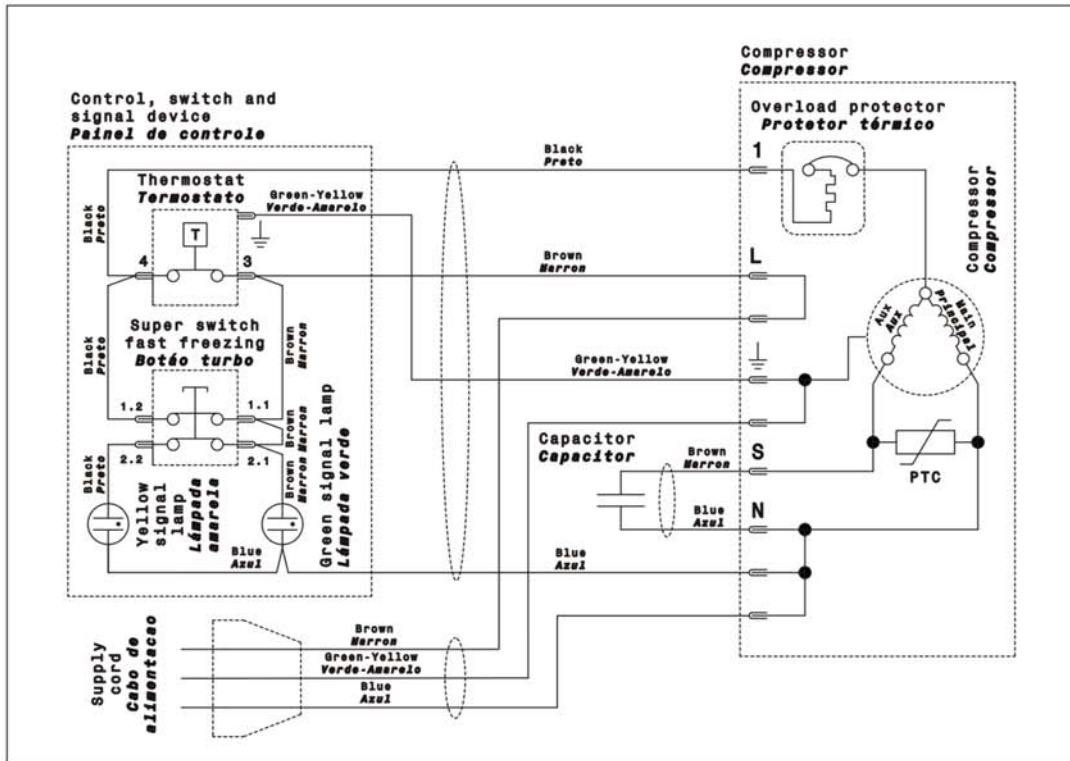

# 7 Troubleshooting for non-operation of compressor

