

LOKRING SIZES AND CODES

PREPARING PIPES FOR JOINING

Since joints are hermetically sealed, it is essential the ends of the pipes be cut at right angles and free from grooves or burr.

Therefore, sand the ends of the pipes using fine sandpaper, moving in a circular motion.

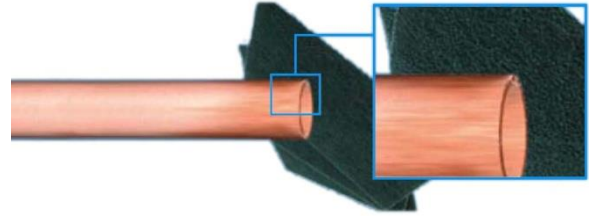

Apply insulating mastic around the entire circumference, making sure none enters inside the pipe. It is thus recommended a small paste-free edge be left at the end of the pipe.

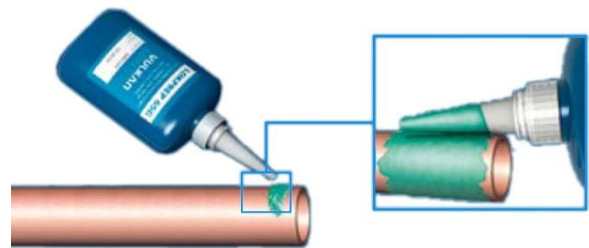

Insert the pipes inside the joint with a turning motion, so as to spread the previously applied mastic evenly over the entire surface.

Ensure the pipes are fully inserted.

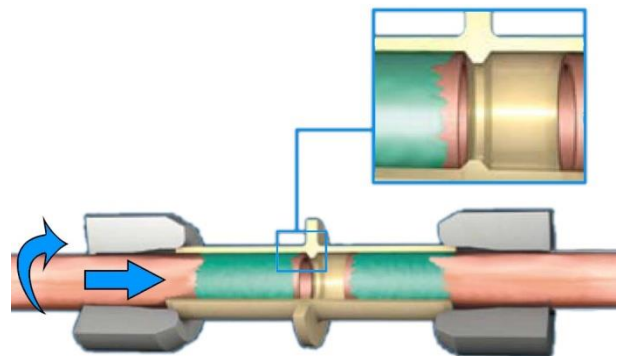

Position the pliers so that the jaws make good contact with the two rings and then tighten until both rings are in close contact with the central stop.

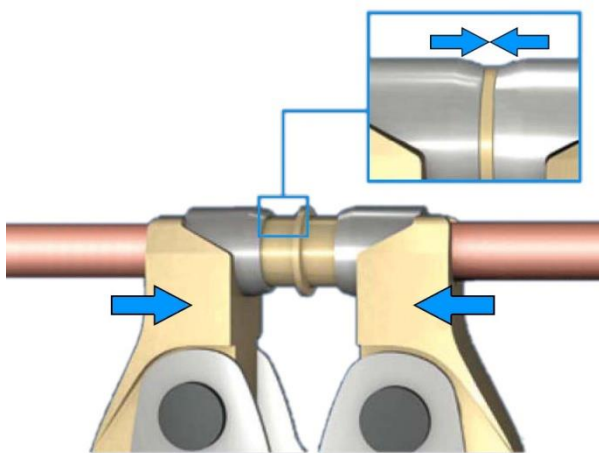

Correct position

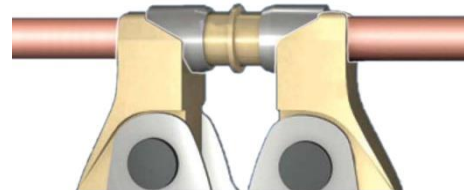

Incorrect position

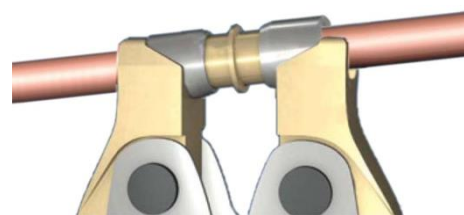

PIPE MATERIALS AND THE CORRESPONDING LOKRING JOINTS

The table reports the lokring joint materials for the various connections joining pipes of the same or different materials.

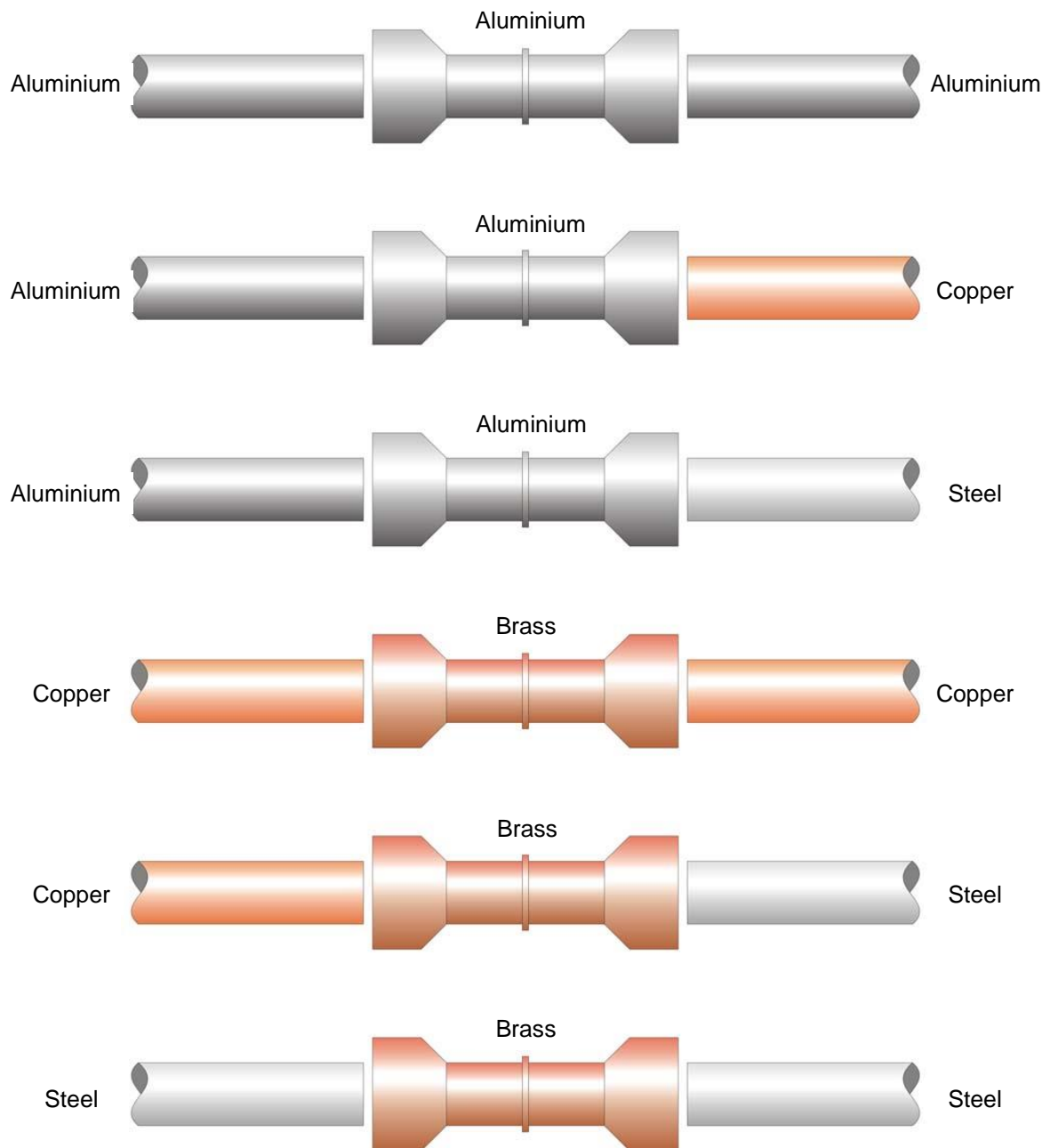

THE MEANING OF LOKRING JOINT INFORMATION

- **LokRing joint material**

AL aluminium
MS brass

- **LokRing joint type**

NK joint between pipes of the same diameter
NR joint between pipes with different diameters
NTK 3 way joint between pipes of the same diameter
NTR 3 way joint between pipes of different diameters
SV Schrader valve
VS end-piece
NAV extension

- **Crimp type**

00 pressure exerted between both outer rings at the same time

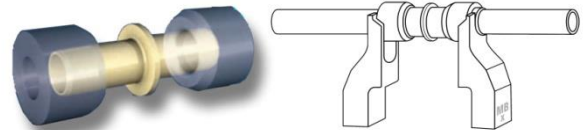

25 pressure exerted between both outer rings at the same time, where the space between the joint and the wall (compressor or other) is narrow

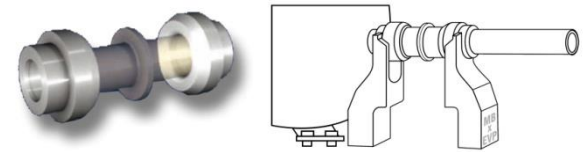

50 pressure exerted between the outer ring and the central ridge unilaterally.

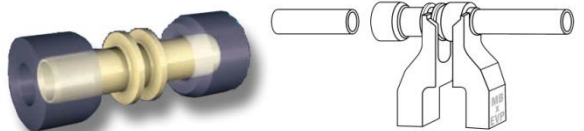

E.g.: LOKring 8/7, 5 NR Ms SV 00

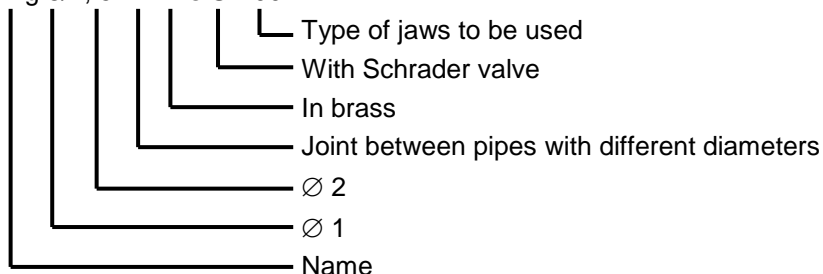

CODES AND SIZES OF THE VARIOUS LOKRING JOINTS

Aluminium joints (AL) Same diameter (NK)

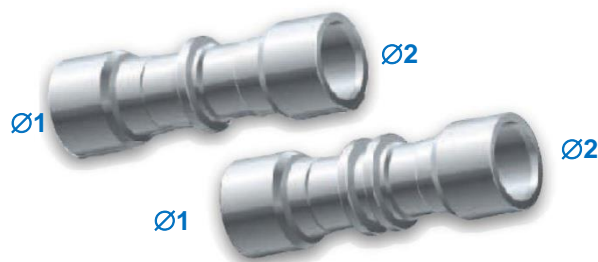

Electrolux Code	Name	Ø 1	Ø 2	Ø 3	Lokring type	Lokring material	Special joints
8996710682619	LOKring 5 NK AI 00	5	5		NK	AL	
8996710682601	LOKring 6 NK AI 00	6	6		NK	AL	
50299990007	LOKring 8 NK AI 00	8	8		NK	AL	

Aluminium joints (AL) different diameters (NR)

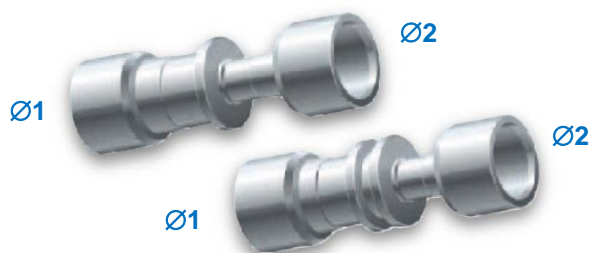

Electrolux Code	Name	Ø 1	Ø 2	Ø 3	Lokring type	Lokring material	Special joints
50292811002	LOKring 5/1.8 NR AI 00	5	1.8		NR	AL	
50292809006	LOKring 5/2 NR AI 00	5	2		NR	AL	
50299991005	LOKring 5.5/3 NR AI 00	5.5	3		NR	AL	
8996710682783	LOKring 6/5 NR AI 00	6	5		NR	AL	
8996710684607	LOKring 7/5 NR AI 00	7	5		NR	AL	
8996710682775	LOKring 7/6 NR AI 00	7	6		NR	AL	
4006161873	LOKring 7.5/6 NR AI 00	7.5	6		NR	AL	
50286722009	LOKring 8/1.8 NR AI 00	8	1.8		NR	AL	
8996710682767	LOKring 8/6 NR AI 00	8	6		NR	AL	
8996710712580	LOKring 8/7 NR AI 00	8	7		NR	AL	
8996710682759	LOKring 8/7.5 NR AI 00	8	7.5		NR	AL	
50299989009	LOKring 12/9.53 NR AI 50	12	9.53		NR	AL	

Brass joints (MS) Same diameter (NK)

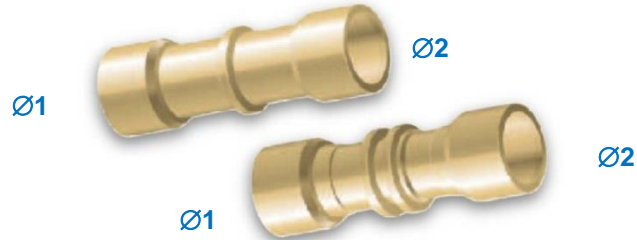

Electrolux Code	Name	Ø 1	Ø 2	Ø 3	Lokring type	Lokring material	Special joints
4071314381	LOKring 1.8 NK Ms 00	1.8	1.8		NK	MS	
8996710682593	LOKring 2 NK Ms 00	2	2		NK	MS	
8996710689838	LOKring 4 NK Ms 00	4	4		NK	MS	
8996710698557	LOKring 5 NK Ms 00	5	5		NK	MS	
8996710698565	LOKring 6 NK Ms 00	6	6		NK	MS	
4002003749	LOKring 7 NK Ms 00	7	7		NK	MS	
4006162178	LOKring 7.5 NK Ms 00	7.5	7.5		NK	MS	
8996710682569	LOKring 8 NK Ms 0	8	8		NK	MS	
4055233706	LOKring 8 NK Ms 25	8	8		NK	MS	
4055347043	LOKring 8,5 NK Ms 00	8,5	8,5		NK	MS	

Brass joints (MS) different diameters (NR)

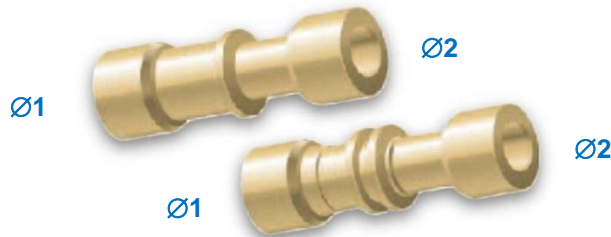

Electrolux Code	Name	Ø 1	Ø 2	Ø 3	Lokring type	Lokring material	Special joints
4071314399	LOKring 2/1.8 NR Ms 00	2	1.8		NR	MS	
4055036422	LOKring 3/1.8 NR Ms 00	3	1.8		NR	MS	
4055070447	LOKring 3/1.8 NR Ms 00	3	1.8		NR	MS	
1110010002174	LOKring 3/2 NR Ms 00	3	2		NR	MS	
8996710689846	LOKring 3.5/2 NR Ms 00	3.5	2		NR	MS	
50294815001	LOKring 4/1.8 NR Ms 00	4	1.8		NR	MS	
8996710689820	LOKring 4/2 NR Ms 00	4	2		NR	MS	
8996710684623	LOKring 5/1.6 NR Ms 00	5	1.6		NR	MS	
4071313821	LOKring 5/1.8 NR Ms 00	5	1.8		NR	MS	
8996710682833	LOKring 5/2 NR Ms 00	5	2		NR	MS	
8996710698631	LOKring 5/3 NR Ms 00	5	3		NR	MS	
8996710684631	LOKring 5/4 NR Ms 00	5	4		NR	MS	
4006106787	LOKring 6/2 NR Ms 00	6	2		NR	MS	

Electrolux Code	Name	∅ 1	∅ 2	∅ 3	Lokring type	Lokring material	Special joints
4006106829	LOKring 6/4 NR Ms 00	6	4		NR	MS	
4006097564	LOKring 6/4.5 NR Ms 00	6	4.5		NR	MS	
8996710698573	LOKring 6/5 NR Ms 00	6	5		NR	MS	
4055175881	LOKring 6,5/4 NR Ms 00	6,5	4		NR	MS	
4006009718	LOKring 6.5/5 NR Ms 00	6.5	5		NR	MS	
4006080123	LOKring 6.5/6 NR Ms 00	6.5	6		NR	MS	
4071301172	LOKring 7/4.5 NR Ms 00	7	4.5		NR	MS	
8996710698581	LOKring 7/5 NR Ms 00	7	5		NR	MS	
8996710682668	LOKring 7/6 NR Ms 00	7	6		NR	MS	
4006012852	LOKring 7.5/2 NR Ms 00	7.5	2		NR	MS	
4006012860	LOKring 7.5/5 NR Ms 00	7.5	5		NR	MS	
4006105227	LOKring 7.5/6 NR Ms 00	7.5	6		NR	MS	
4055045985	LOKring 7.5/6.5 NR Ms 00	7.5	6.5		NR	MS	
4006161857	LOKring 8/4 NR Ms 00	8	4		NR	MS	
8996710698599	LOKring 8/5 NR Ms 00	8	5		NR	MS	
8996710682635	LOKring 8/6 NR Ms 00	8	6		NR	MS	
4006105250	LOKring 8/6.5 NR Ms 00	8	6.5		NR	MS	
4006161865	LOKring 8/7 NR Ms 00	8	7		NR	MS	
8996710713570	LOKring 8/7.5 NR Ms 00	8	7.5		NR	MS	
50296397008	LOKring 9/8 NR Ms 00	9	8		NR	MS	
4071384483	LOKring 9/8 NR Ms 50	9	8		NR	MS	
4006105276	LOKring 9.53/5 NR Ms 00	9.53	5		NR	MS	
4006105284	LOKring 9.53/6 NR Ms 00	9.53	6		NR	MS	
4006007969	LOKring 9.53/7.5 NR Ms 00	9.53	7.5		NR	MS	
4006007845	LOKring 9.53/8 NR Ms 00	9.53	8		NR	MS	
50296398006	LOKring 10/6 NR Ms 00	10	6		NR	MS	
8996710682627	LOKring 10/8 NR Ms 00	10	8		NR	MS	
50296396000	LOKring 10/9.53 NR Ms 00	10	9.53		NR	MS	
4071384509	LOKring 10/9.53 NR Ms 50	10	9.53		NR	MS	
4006108973	LOKring 11/6 NR Ms 00	11	6		NR	MS	
4006105359	LOKring 11/8 NR Ms 00	11	8		NR	MS	
53188947542	LOKring 11/8 NR Ms 00	11	8		NR	MS	

Three-way brass joints (MS) between different diameters (NTR)

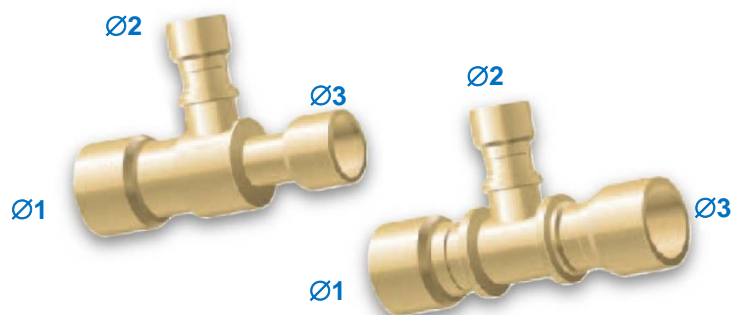

Electrolux Code	Name	Ø 1	Ø 2	Ø 3	Lokring type	Lokring material	Special joints
4006162061	LOKring 7/6/2 NTR Ms 00	7	6	2	NTR	MS	3 way reduction
8996710712564	LOKring 7.5/6/2 NTR Ms 00	7.5	6	2	NTR	MS	3 way reduction

Brass joints (MS) Same diameter (NK) with Schrader valve (SV)



Electrolux Code	Name	Ø 1	Ø 2	Ø 3	Lokring type	Lokring material	Special joints
4071317194	LOKring 5 NK Ms SV 00	5	5		NK	MS	Joint with Schrader Valve
8996710698607	LOKring 6 NK Ms SV 00	6	6		NK	MS	Joint with Schrader Valve
8996710713588	LOKring 7.5 NK Ms SV 00	7.5	7.5		NK	MS	Joint with Schrader Valve
8996710698615	LOKring 8 NK Ms SV 00	8	8		NK	MS	Joint with Schrader Valve
4006161949	LOKring 9.53 NK Ms SV 00	9.53	9.53		NK	MS	Joint with Schrader Valve

Brass joints (MS) different diameters (NK) with Schrader valve (SV)



Electrolux Code	Name	Ø 1	Ø 2	Ø 3	Lokring type	Lokring material	Special joints
8996710698086	LOKring 8/6 NR Ms SV 00	8	6		NR	MS	Joint with Schrader Valve
8996710713562	LOKring 8/7.5 NR Ms SV 00	8	7.5		NR	MS	Joint with Schrader Valve
4006105334	LOKring 9.53/6 NR Ms SV 00	9.53	6		NR	MS	Joint with Schrader Valve
8996710699969	LOKring 10/6 NR Ms SV 00	10	6		NR	MS	Joint with Schrader Valve
8996710698623	LOKring 10/8 NR Ms SV 00	10	8		NR	MS	Joint with Schrader Valve

Schrader valve (SV) with brass pipe (MS)



Electrolux Code	Name	Ø 1	Ø 2	Ø 3	Lokring type	Lokring material	Special joints
4006161931	LOKring 6 NF Ms SV 01	6			NF	MS	Schrader valve

End piece (VS) in brass (MS)



Electrolux Code	Name	Ø 1	Ø 2	Ø 3	Lokring type	Lokring material	Special joints
1110010002497	LOKring 5 VS Ms 00	5			VS	MS	
8996710682809	LOKring 6 VS Ms 00	6			VS	MS	
8996710682791	LOKring 8 VS Ms 00	8			VS	MS	

NAV extension for service pipe



Electrolux Code	Name	Ø 1	Ø 2	Ø 3	Lokring type	Lokring material	Special joints
4006007761	LOKring 6 NAV	6	6		NAV		Extension
8996710714958	LOKring 7 NAV	7	7		NAV		Extension
4006162145	LOKring 7.5 NAV	7.5	7.5		NAV		Extension
8996710714966	LOKring 8 NAV	8	8		NAV		Extension
4006007779	LOKring 9.53 NAV	9.53	9.3		NAV		Extension
8992980017834	LOKring NAV 11	11	11		NAV		Extension

Sealant



Electrolux Code	Name
8996710682825	Lokprep 65G

Pliers



Electrolux Code	Name
8992980014575	LOKTool HMRK-L
4055405627	Plier, HMRK-V

Jaws for LokRing 00

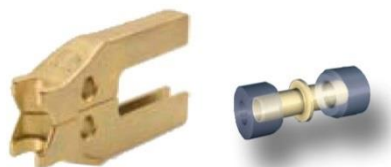

Electrolux Code	Name	Minimum LokRing size Ø mm	Maximum LokRing size Ø mm
8992980014187	LOKtool MB 10	9	11

Jaws for LokRing 25



Electrolux Code	Name	Minimum LokRing size Ø mm	Maximum LokRing size Ø mm
4071384517	LOKtool MB 10 EVP	6	8.5

Jaws for LokRing 50



Electrolux Code	Name	Minimum LokRing size Ø mm	Maximum LokRing size Ø mm
4071384525	LOKtool MB 8 EVP	6	8
4071384517	LOKtool MB 10 EVP	9	11
50299992003	LOKtool MB 12 EVP	12	13

REVISIONS:

Revision	Date	Description	Author	Approved by - on
03	01/2018	New lokring Jaws, for L added		
02	07/2015	New lokring part number added	LG	
01	04/2013	New lokring part number added	KL	
00	12/2011	Document Creation	ADL	