



<p>© ELECTROLUX HOME PRODUCTS Customer Care - EMEA Training and Operations Support Technical Support</p> <p>Edition: 03/2015 - Rev. 00</p>	<p>Publication number</p> <p>599 73 44-69</p> <p>EN</p>	<p>Built-in Ovens & Cookers</p> <p>“VCU” User Interface</p>

Table of Content

1. INTRODUCTION	4
2. OVERVIEW.....	6
3. CONCETP.....	8
4. “VISION VCU” AND TOUCH BOARD FIXING	8
5. MODULAR CONSTRUCTION.....	10
6. ELECTRICAL CONNECTIONS	11
7. MATCHING THE POWER BOARD.....	11
8. CONTROL PANEL.....	11
9. FUNCTIONS AND USE OF VISION VCU INTERFACE.....	18
10. DEMO MODE	20
11. SERVICE MODE (FACTORY TEST).....	20
12. ALARM CODE.....	23
13. SIDEKICK	27
14. REVISIONS:	27

1. INTRODUCTION

1.1 PURPOSE OF THIS MANUAL

The purpose of this Manual is to provide information of new User Interface board OMEGA.

1.2 WARNINGS



All work with open appliances must be done with the mains supply disconnected.

The intervention on electrical equipment should only be performed by qualified personnel.

Before working on a device, check the efficiency of the system housing through means of appropriate equipment. As an example, refer to the indications described / illustrated in the portal Electrolux Learning Gateway (<http://electrolux.edvantage.net>).

After intervention, carry out electrical safety tests and check the correct operation of all safety devices.

In the case of manipulation / replacement of the PCB, use the ESD kit (Code 405 50 63-95/4) to prevent electrostatic discharge damage the circuit board see SB No. 599 72 08-09

1.3 ABBREVIATIONS, ACRONYMS, DEFINITIONS

Abbreviations	Meaning
ABO	Automatically back to OFF_STATE from STAND_BY_STATE
AC	Assisted Cooking
BS	Basic Settings
COT	Current Oven Temperature (= actual temp. in cavity)
Customer Action	Press any key, open the door (if door switch for light), plug in /out food probe
DE	Language = German
DUR	Duration
FC	Food Category
FCT	Food Probe Current Temperature
FPE	Food Probe Extended
FST	Foot Set Temperature
H+H	HEAT+HOLD
KEY_U/D	Key for up/down-selection
LTC	Low Temperature Cooking
MAN	Manuel in Assisted Cooking
MEM	My Programs menu
MM	Minute Minder
MP	Food probe
OFF	Off-State
ON	On-State
OST	Oven Set Temperature
OUI	Oven User Interface
OVF	Oven Function
RTC	Real Time Clock
REC	Recipe
S+G	SET+GO
STB	Stand-By-State
ToD	Time of Day
W	Window
OCT	Oven current temperature
ON_STATE	Oven is running
STAND_BY_STATE	Oven is in standby with standard menu
OFF_STATE	Oven is Off, ToD indication
tbd	to be defined

2. OVERVIEW

The VISION VCU interface is a new high end oven user interface for the cooking appliance.

VISION VCU replacing Avantgarde and ENV06 Smart Culisense.

The user interface concept based on today's Vision ENV06



Avantgarde



ENV06 Smart Culisense

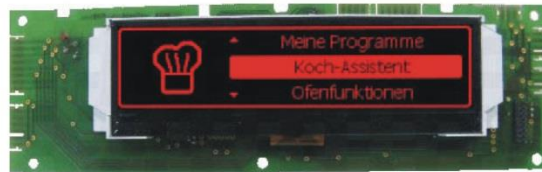

HDC06671.JPG

VCU

Vision Cooking Update

Construction with one PCB, the same for OMEGA and VISION (VCU)



HDC04903.JPG

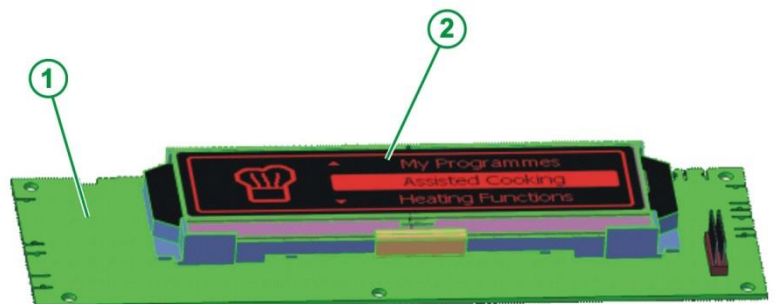

HDC04905.JPG

1. CONNECTION PCB
2. VISION (VCU) DISPLAY

2.1 RANGE OF APPLICATION AND SPECIFIC FEATURES

There are several variants of ovens and cookers with Vision VCU interface in various structures, combined with the power board OVC3000 in different aesthetic and brands with the following features:

- Pyro
- Non-Pyro
- Catalytic
- Meat Probe
- Steam
- Microwave

The main features of the Vision VCU interface are:

Full Dot Matrix Display

LCD Modul

same μC family (Renesas) for all interfaces Omega and Vision VCU

flexibility with different glass designs (new designs can be realized very fast)

supports nonPyro, Pyro appliances

supports Steam functionality

supports MW functionality

supports double oven appliance

support 10 digital Inputs for touch sensor fields

2.2 DIFFERENT VERSIONS

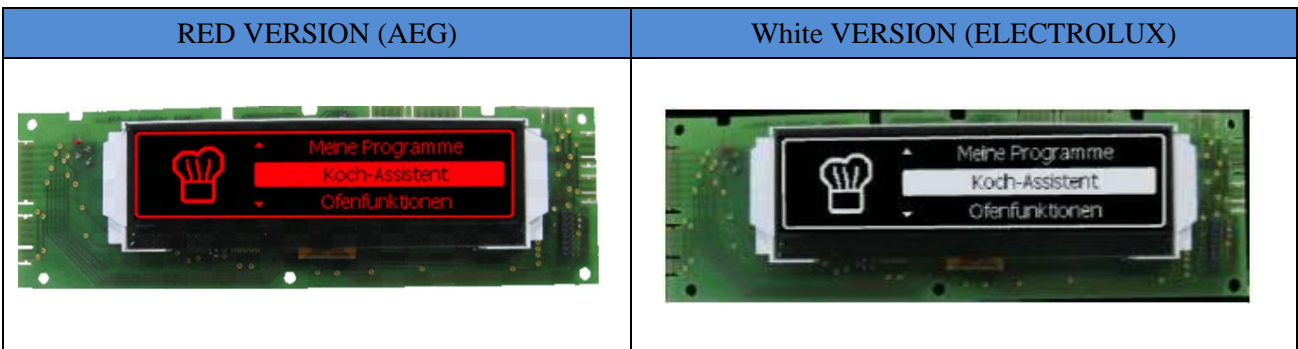

NOTE: The different Hardware versions of Vision VCU Interface through the various software give rise to different codes programmed interface adapted to the different types and functions of the oven

3. CONCETP

All glass variants should be adapted to this PCB.
 same connection PCB <-> glass
 same connection PCB <-> LCD module
 same position

1. FUTURE DESIGN DISPLAY
2. VISION VCU DISPLAY
3. OMEGA DISPLAY
4. CONNECTION PCB (BASIS PCB)

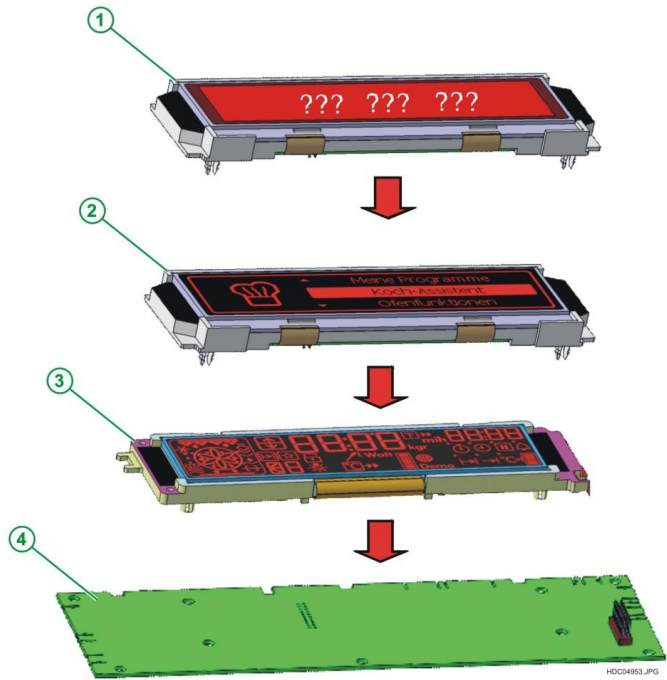

4. “VISION VCU” AND TOUCH BOARD FIXING

The touch-zones-board is connected over the connector only. No additional wiring is needed.

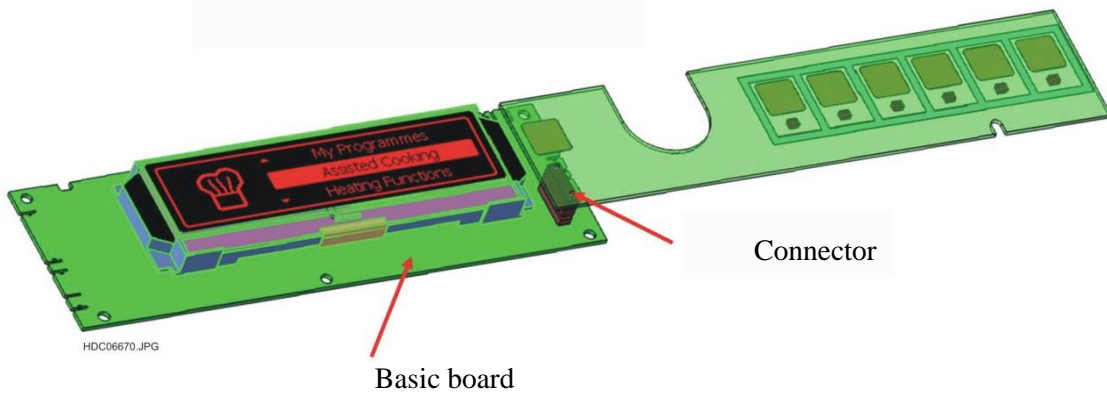

4.1 “VISION VCU” - 7 TOUCH ZONES

Touch-7-zones-board

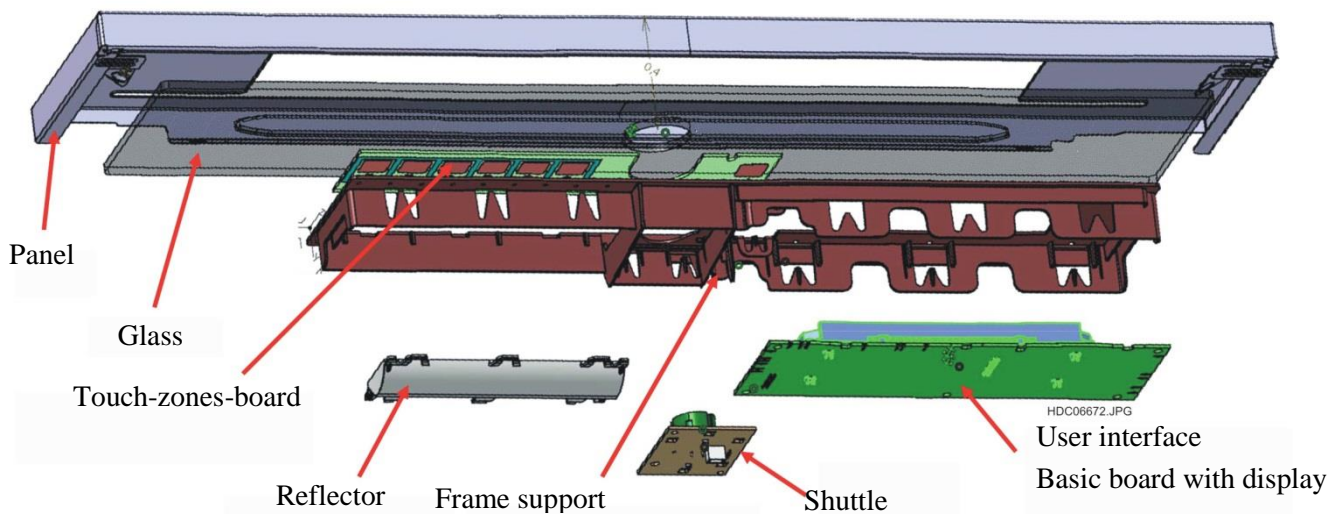

Attention ! Please be careful, during disassembling and assembling the boards !

NOTE: For the fixing system in the various applications and aesthetic refer to manuals Service relating (Apollo structure, Sputnik structure etc.).

4.2 "VISION VCU" - 10 TOUCH ZONES

Touch-10-zones-board

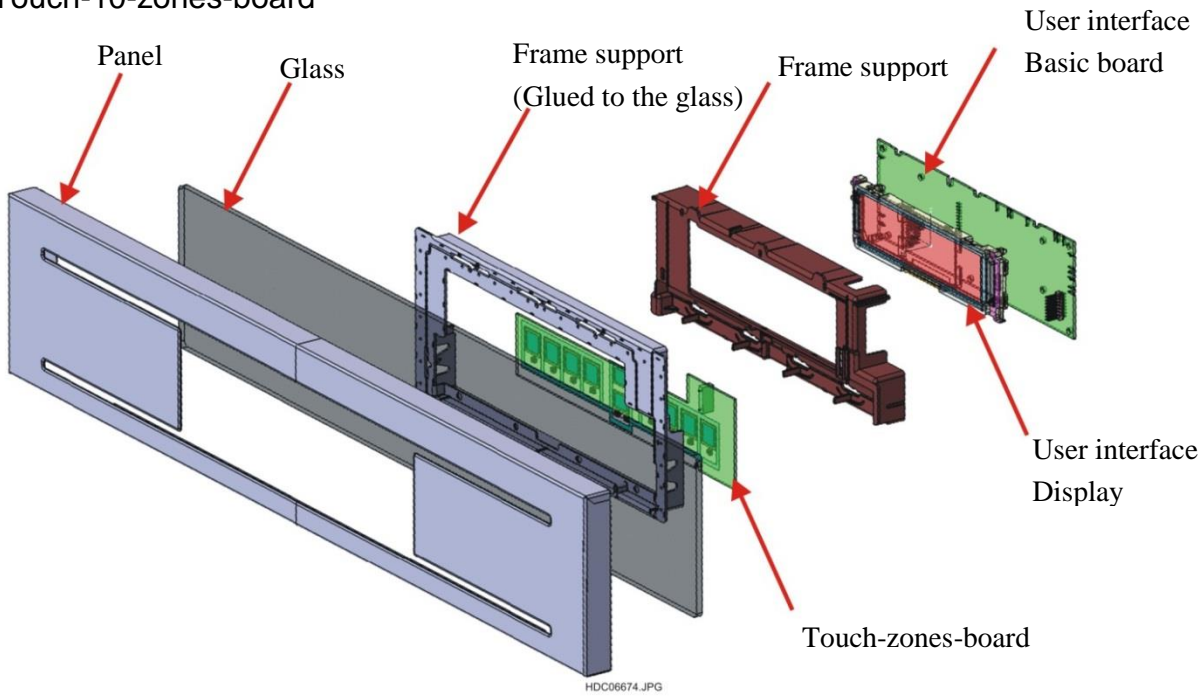

4.3 CONNECTORS OF BASIS PCB

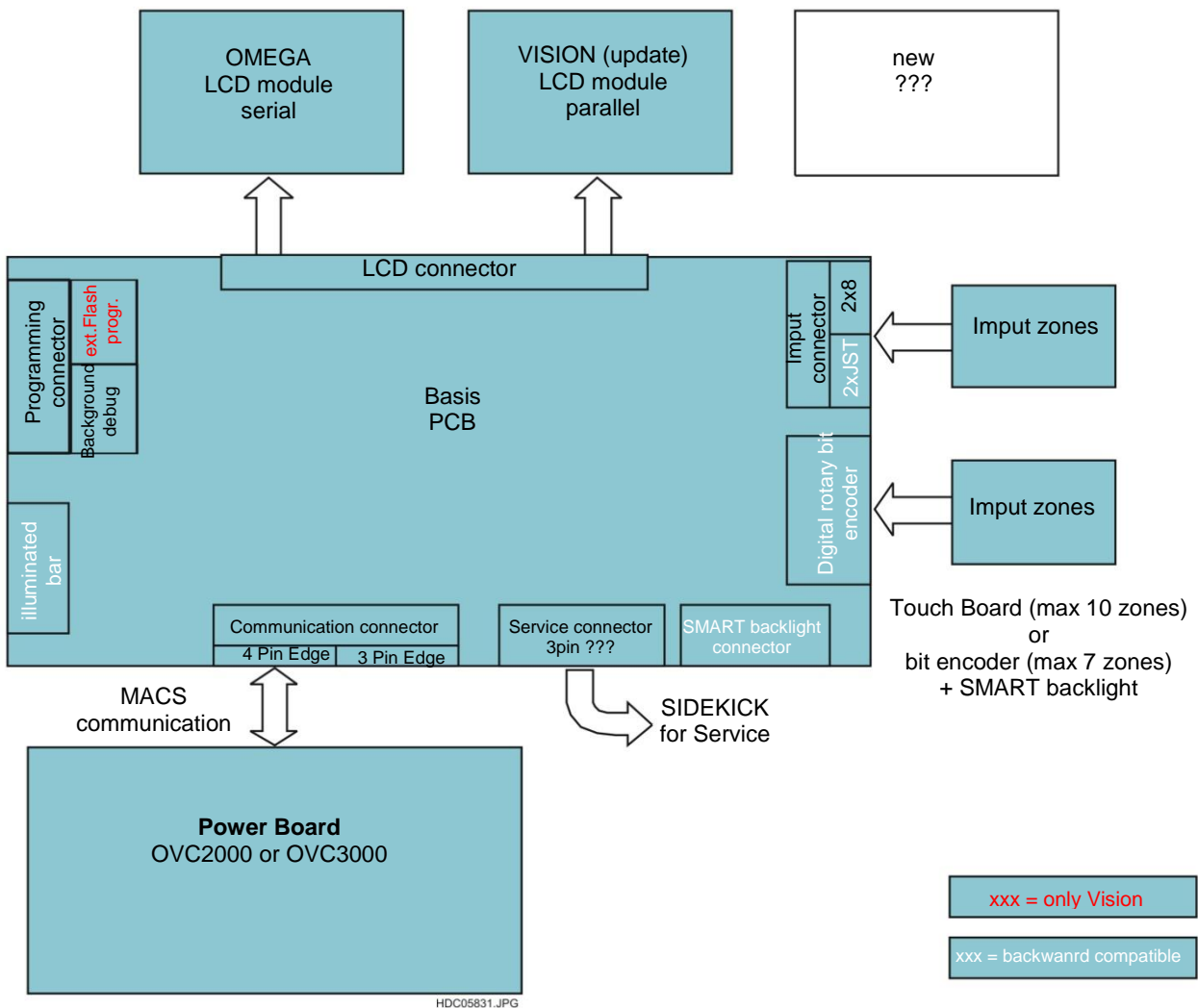

4.4 NEEDED CONNECTOR FOR “VISION VCU”

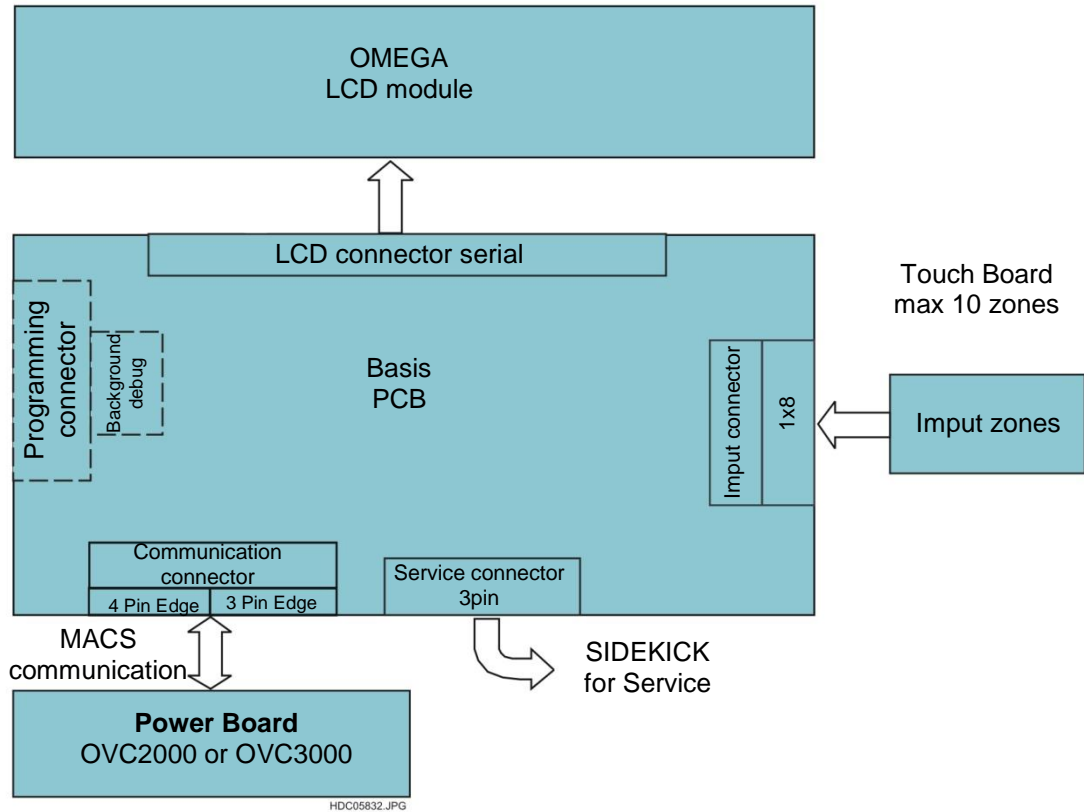

5. MODULAR CONSTRUCTION

The touch-zones-board is connected over the connector only. No additional wiring is needed.
ATTENTION: Please be careful, during disassembling and assembling the boards !

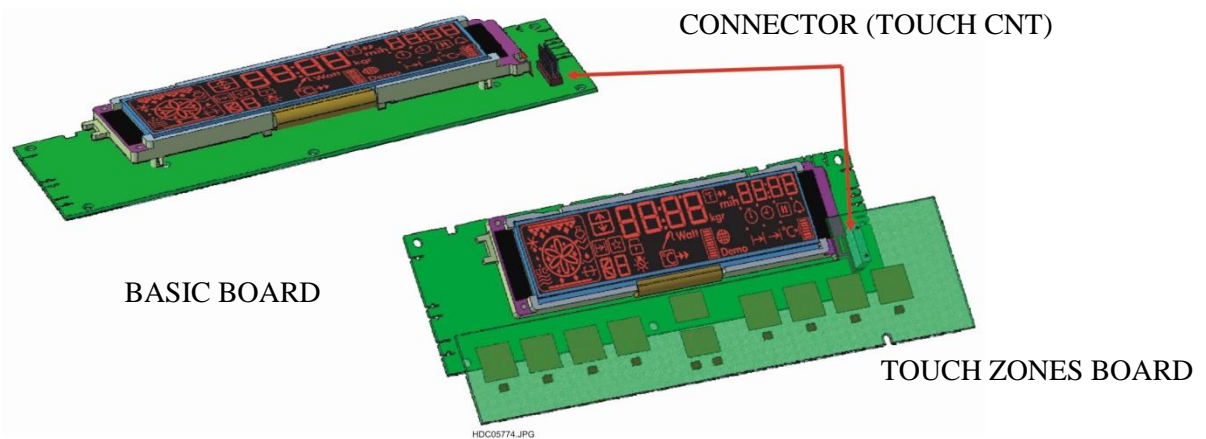
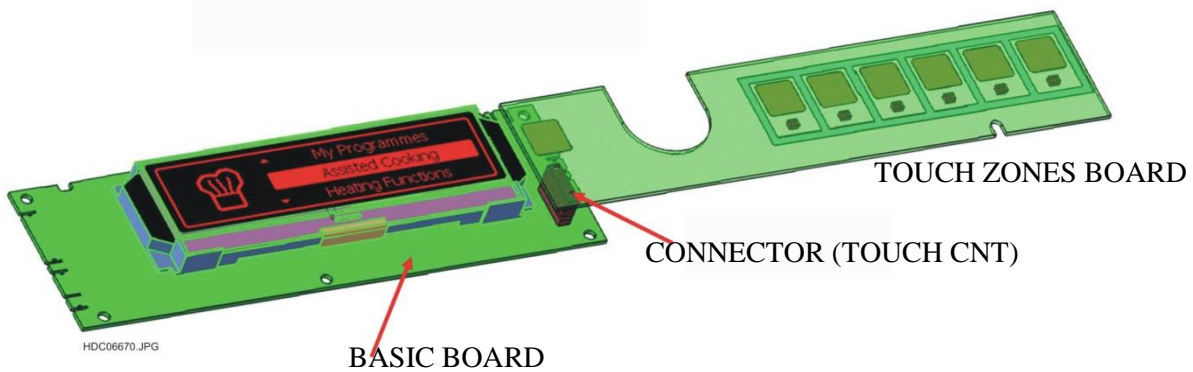

6. ELECTRICAL CONNECTIONS

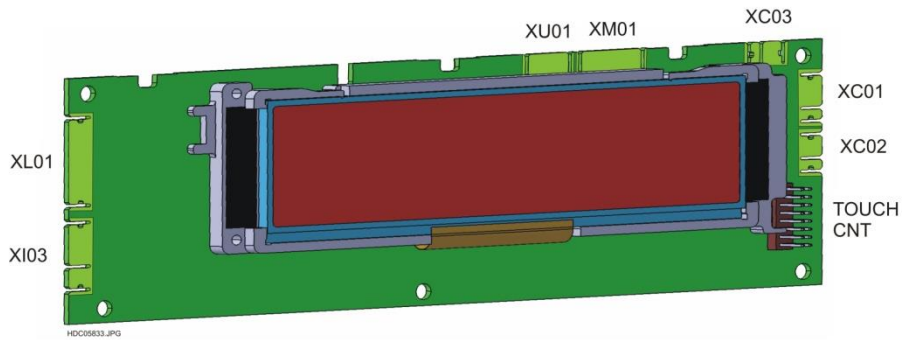

XC01 MACS BUS FOR POWER BOARD

XC02 AUXILIARY MACS BUS

XC03 MACS BUS FOR SIDEKICK (SERVICE)

XI03 DIGITAL ROTARY BIT ENCODER AND INPUT BLOCK

XL01 TOUCH BOARD BACKLIGHT

XM01 PROGRAMMING FLASH MEMORY

XU01 PROGRAMMING

TOUCH CNT INPUT TOUCH BOARD (15 PIN)

7. MATCHING THE POWER BOARD

The user interface Vision VCU can be combined, depending on the version and specific appliances to the power board OVC2000 or OVC3000 with FPM board for the food probe.

Also refer to the Service Manual in TDS related to power boards linked to specific models.

8. CONTROL PANEL

Example of control panel with user interface Vision VCU

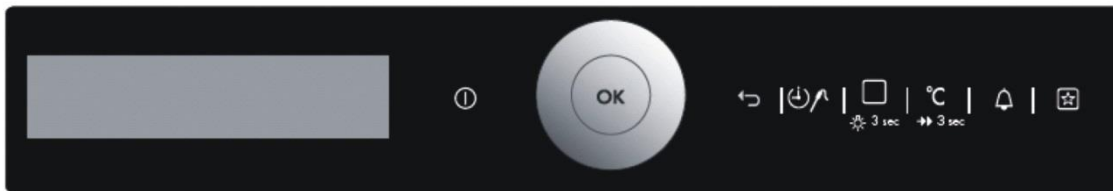

8.1 EXAMPLE OF FUNCTION KEYS

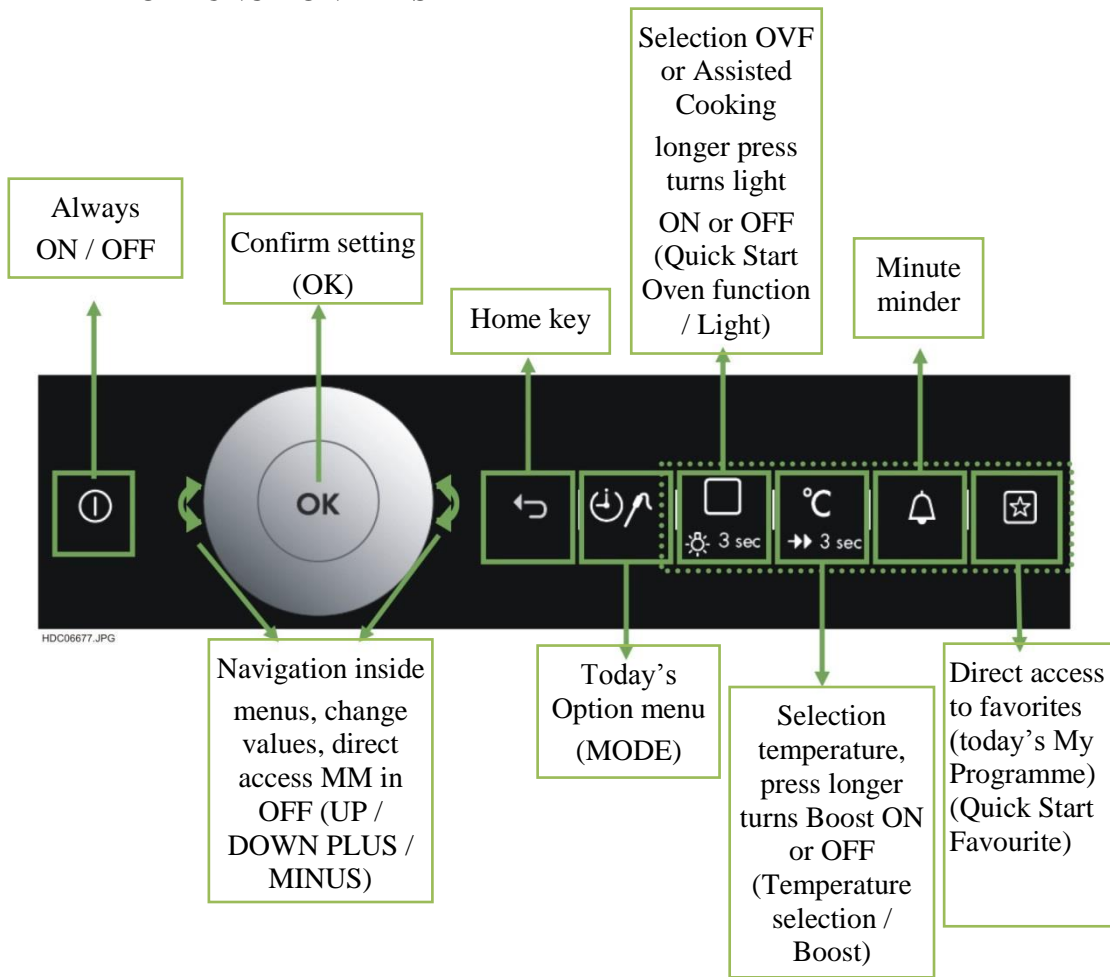

8.2 DIFFERENT KEY LAYOUT

Following key layout includes touch zones positioning. The OVC has 7 and 10 zones key layout. Depending on which variant the key layout is diversify

8.2.1 7 ZONES HORIZONTAL WITH ROTARY

Key layout: 7-Zones Horizontal with rotary

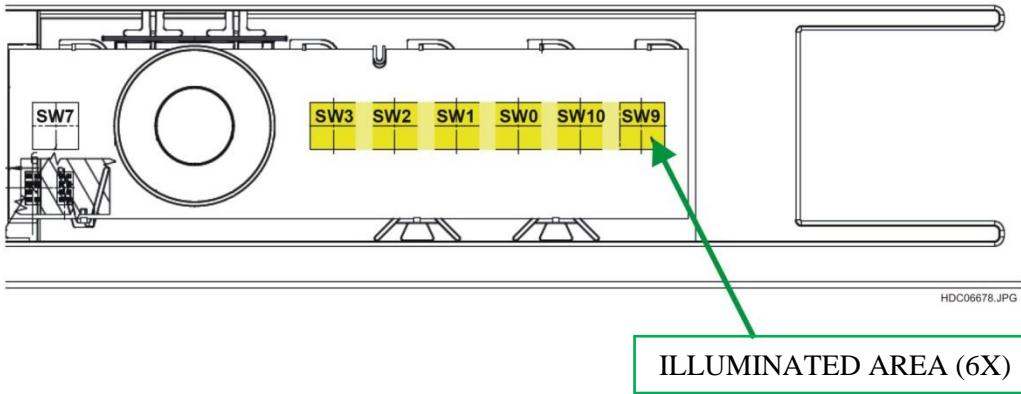

For normal oven, like non pyro, catalytic, or steam:

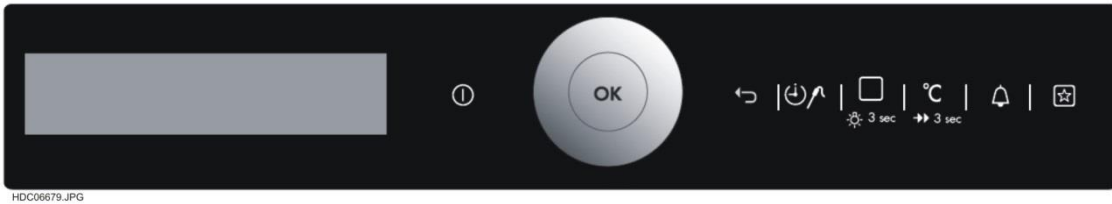

For double oven:



For Millenium:

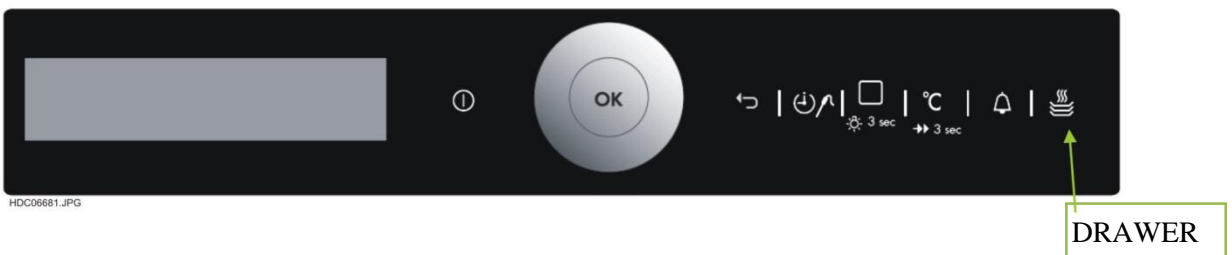

8.2.2 10 ZONES

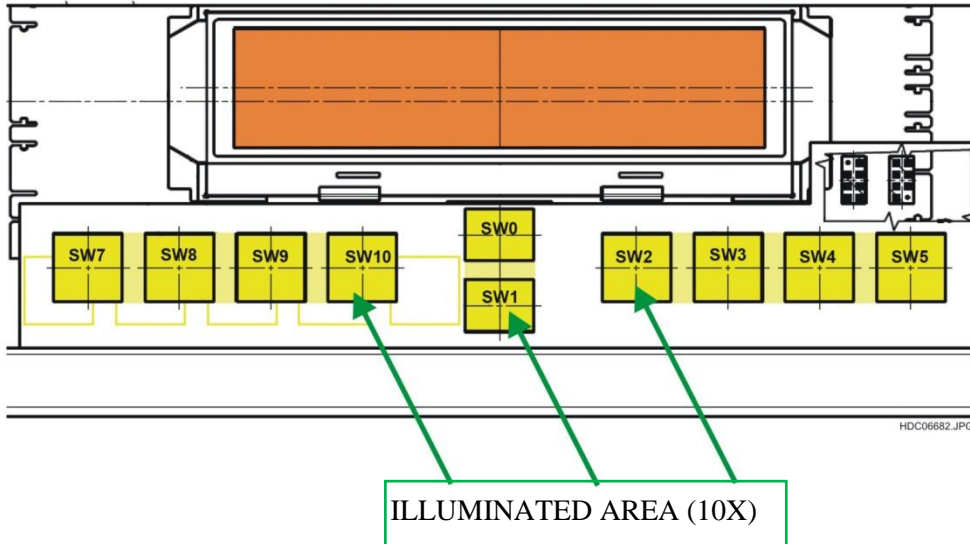

For normal oven, like non pyro, catalytic, or steam:

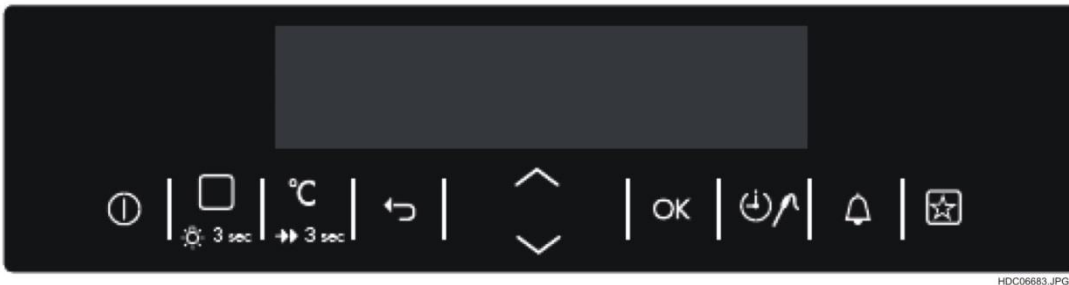



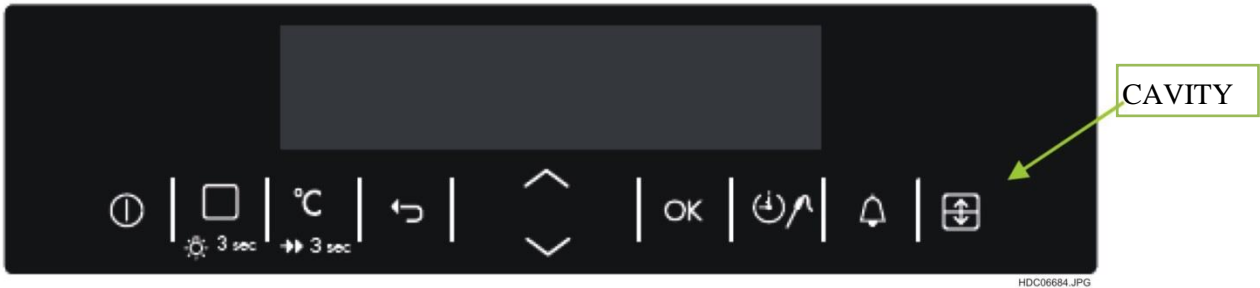



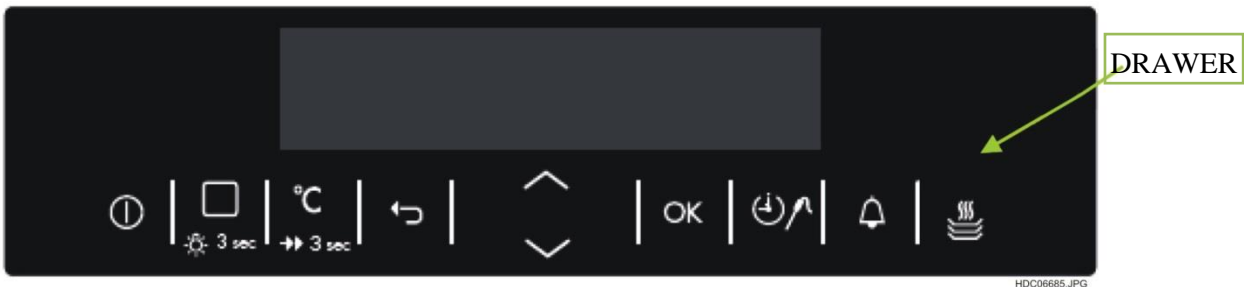



For double oven:







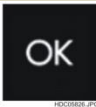

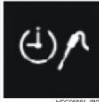

For Millenium:

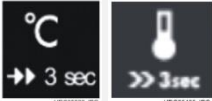

8.3 FUNCTION OF KEYS

KEY SYMBOL	KEY NAME	DESCRIPTION
	KEY_MAIN	<p>Main Key</p> <ul style="list-style-type: none"> From OFF_STATE to STAND-BY_STATE and vice-versa. Always with function ON/OFF. If multi-key-action this key has master function (leads always to STAND-BY resp. OFF_STATE).
	KEY_HOME	
  	KEY_UP KEY_DOWN	<p>Scroll buttons (rotary functionality in 7-zone touch layout)</p> <ul style="list-style-type: none"> After selection of oven function, program selection or temperature, these two keys can be used for set up or set down the corresponding function. If the oven is running and no selection is blinking, then this is also used for set temperature directly (In micro wave no function). The KEY_UP and KEY_DOWN also be used for set timer functions.
  	KEY_PLUS KEY_MINUS	<p>(rotary functionality in 7-zone touch or UP / DOWN in 10-zone touch)</p> <ul style="list-style-type: none"> Adjusting values like oven set temperature, food set temperature, weight, duration, type of Pyrolytic Cleaning etc. Selecting value in basic settings menu (ON/OFF, YES/NO, levels, language, etc.) If defining own memory name selecting character To adjust oven set temperature, weight or type of Pyrolytic Cleaning the first key press changes window/indicator (arrow for OST, weight symbol or text for Pyrolytic Cleaning is flashing), the second key press changes the value Single pressing change the information in single steps, keeping the button pressed for a longer time increase speed
 	KEY_OK	<p>Confirm selection</p> <ul style="list-style-type: none"> Pressing this button, customer can confirm settings, e.g. minute minder, or the settings. In microwave oven this button can be switch on the microwave with the maximum power and a time of 30 seconds. Each press on this key add 30seconds to the duration. <p>Cleaning conformation</p> <ul style="list-style-type: none"> Oven does not start before customer press KEY_OK.

	KEY_MODE	<p>Time mode selection</p> <ul style="list-style-type: none"> Switches the between Time the different time functions. Set of these values with KEY_UP and KEY_DOWN. See chapter 9.10 - TIME / MODE MENU for the correct order.
	KEY_OVF	<p>Quick Start Oven function</p> <ul style="list-style-type: none"> Activate oven function menu
	KEY_TEMP and KEY_BOOST	<p>Temperature selection and Boost</p> <ul style="list-style-type: none"> Pressing to Current oven temp COT (Current Oven Temperature). With food probe inside, switch between FST (Food Probe Set Temperature), COT (Current Oven Temperature) and FCT (Food Probe Current Temperature). Pressing this button for more than 3 seconds, the quick heat turns on. If the customer presses the button a second time longer than 3 seconds, fast heat up is deactivated.
	KEY_MM	<p>Minute minder selection</p> <ul style="list-style-type: none"> Switches to minute minder set state. Set values with KEY_UP and/or KEY_DOWN. See chapter minute minder for more details.
	KEY_DRAWER	<p>Drawer</p> <ul style="list-style-type: none"> Switches on/off the drawer heater
	KEY_LIGHT	<p>Light</p> <ul style="list-style-type: none"> Turn the light ON / OFF at the whole time.
	KEY_FAVOURITE	<p>Quick Start</p> <ul style="list-style-type: none"> A special oven functions with pre-defined temperature and a pre- defined time. A new favourite program can always be saved with a key press longer than 3 seconds. It is possible to save max. 20 Programmes.
	KEY_CAVITY	<p>Cavity selection</p> <ul style="list-style-type: none"> Pressing this button, switch between upper and lower cavity.

8.3.1 KEY COMBINATIONS OVERVIEW

FUNCTION	ACTION	KEY COMBINATION
Child safety	Activate / deactivate	KEY_MODE + KEY_FAVOURITE
Timer	Set value to zero	KEY_MINUS + KEY_PLUS
Demo mode	Activate / deactivate after switch on / off over KEY_MAIN.	KEY_MODE + KEY_FAVOURITE
Factory test	Activate after start up (Logo).	KEY_OK + KEY_MODE
Function lock deactivate	Activate in menu	KEY_MODE then KEY_OK

9. FUNCTIONS AND USE OF VISION VCU INTERFACE

9.1 INITIAL OPERATION (START-UP PROCEDURE)

The start-up procedure of the appliance is divided in 2 parts. If a factory test was done the appliance reacts after plug-in as described for first connection with mains.

9.1.1 FIRST CONNECTION WITH THE MAINS

After the first connection with the mains (resp. after connection with mains after factory test) the following sequence starts:

1. Displaying manufacturer logo for 7 seconds.



2. For the next 7 seconds displaying software version from
Firmware OUI
Configuration OUI
Firmware PB and
Working hours counter (only value)

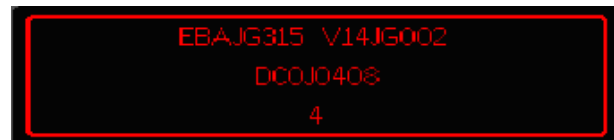

The indication is the same like settings menu “basic settings” item “service”.

3. Set language in the same way as in basic settings menu. The selected language will be stored in flash memory. The user has to do later changes in the menu “basic settings”.
4. The next point is to set the display contrast. This is the same flow as is described in chapter “basic settings” item “display contrast”. The value will be stored in flash memory. All later changes can be done in menu “basic settings”
5. After setting the display contrast, set display brightness. This is the same flow as is described in chapter “basic settings” item “display brightness”. All later changes can be done in menu “basic settings”
6. Afterward set of ToD, same way as is described in chapter “basic settings” item “set time of day”. This setting synchronizes the RTC. Then the RTC delivers a ToD value – even a short time after power failure. All later changer of ToD can be done in menu “basic settings”.
7. Interface in OFF_STATE with ToD indicated resp. also residual heat indication (if activated and value for available).

9.1.2 ANY FURTHER CONNECTION WITH THE MAINS

Any further connection with the mains affects the following sequence:

1. Displaying manufacturer logo for 7sec...
2. Display software versions and working hours counter.
3. ToD setting – only if a ToD value is not available anymore (from RTC).
4. Interface in OFF_STATE with ToD indicated resp. also residual heat indication (if activated and value for available).

Valid for both connections:

As long as manufacture logo is displayed it is possible to enter the factory test. The workflow of the factory test is described in chapter Factory Test.

9.2 OFF_STATE

When the oven is switched off, the time of day (ToD) is displayed and, in case of residual heat in oven, also the temperature bar for residual heat indication. Depending of application also with real temperature in °C (e.g. for steamer applications necessary). ToD can be switched off to set the display completely dark. This has to be done in basic settings menu.



9.2.1 DAY / NIGHT BRIGHTNESS

The OUI reduces the brightness of ToD indication in *OFF_STATE* in the timeframe 22:00 until 06:00 o'clock to level 1. After customer interaction the OUI stays 5seconds in last used brightness (day brightness).

9.2.2 RESIDUAL HEAT DISPLAY

- Decreasing bar - same animation and position as heating indication in ON_STATE.
- At steamer applications in real degrees without state bar.
- Disappears if cavity temperature less than 40°C.
- Animation shows a relation between cavity temperature/oven set temperature.



9.2.3 STANDBY-STATE

To reach the standby-state, the appliance must be in the off-state. Afterwards press once more the on-/off-key . The main menu is displayed.

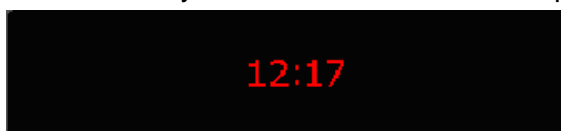

Off State



Standby-state / Main Menu

This is the starting point for all functions.

If no key is pressed, after 2 minutes, the appliance is changed automatically from standby-state in to off-state.



10. DEMO MODE

The Demo Mode is implemented for demonstrating the functionality of the appliance in show rooms or shops, on trade fairs etc. without energy consumption behind. The user can find out the complete functionality of the OUI but for security reason the loads (heating elements) stays off.

10.1 WORKFLOW TO ACTIVATE / DEACTIVATE DEMO MODE

To activate / deactivate the demo mode:





1. From *OFF_STATE* keep the main switch pressed for at least 5 seconds.
2. The user interface enters *STAND_BY* for 5sec. and jump back to *OFF_STATE*. Buzzer sounds (Tone_1)
3. Then release the main switch and press the combination KEY_MODE  + KEY_FAVOURITE  for two seconds .
4. Buzzer sounds (3 x Tone_1) and
 - The Demo Mode is active now. Indication of Demo Mode in left upper corner with Layout_18 and Icon10_1.
 - The demo mode is deactivated now. No indication of Icon10_1.

11. SERVICE MODE (FACTORY TEST)

The factory test is implemented to check all electrical components of the appliance at the end of the production line. This test can only be activated as long as manufacture logo is displayed.

This function can also be used by the Service for troubleshooting.

11.1 SERVICE MODE ACTIVATION

Activation will be done by pressing KEY_HOME  + KEY_MODE  simultaneous for 2seconds until the buzzer sounds (Tone_1). After activation of the factory test the display starts with the first activated loads of main cavity.

11.2 SERVICE MODE DEACTIVATION

Pressing the KEY_MAIN  together with another key you can terminate the factory test.

The factory test should be deactivated after 5 minutes without any user interactions

If the factory test was done, the user can deactivate the factory test with the KEY_MAIN . After that the oven has to be disconnected from the mains.

11.3 SERVICE MODE WORKFLOW

The user has to follow this workflow step by step.

11.3.1 TEST OF HEATING ELEMENTS

The test of the heating elements starts automatically at entering the factory test. By pressing KEY_UP  the customer will activate the next test item. The active components will be shown in the display.



The sequence of the loads depends on the configuration of the oven. The correct order of the heating Elements is described in the configuration specification.

Following sequence is only an example!

1. Grill + turnspit + cooling fan low + lamp
2. Bottom + smell filter + cooling fan high
3. Top + cooling fan low + lamp
4. Rear + cooking fan + cooling fan low + lamp
5. Smell filter + cooling fan high

11.3.2 TEST OF TEMPERATURE SENSOR

Pressing the KEY_OK **will activate** the test of temperature sensor. Display shows temperature of main cavity OCT (oven current temperature).



11.3.3 TEST OF FOOD PROBE SENSOR

The food probe will be tested with a special food probe tester. This device simulates different food probe temperatures (by changing resistor value).

The user has to press the KEY_OK to go to this test point. Alternative the display shows "FCT" after plug in the food probe tester. By pressing the button at food probe tester the displayed temperature changes (e.g. 30°C/80°C). This test point also appears if the appliance has no food probe sensor plug in. in this case the user can jump over this test point.



11.3.4 DISPLAYING SOFTWARE VERSION

By pressing the KEY_OK the display shows the different versions of user interface, power board and the working hours.

First line: Firmware and configuration from OUI.

Second line: Firmware from power board.

Third line: Operating hours.

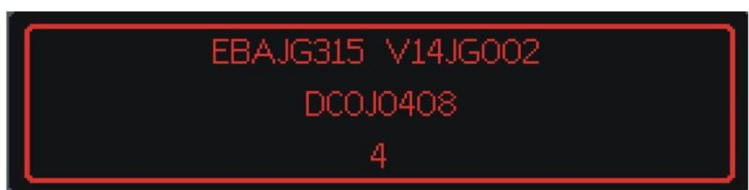

11.3.5 DISPLAY TEST

With KEY_OK the display switches to different display tests.

First step is showing all pixels with backlight.



Next press of KEY_OK show the display without pixels and backlight is on.



Next press of KEY_OK show a split display with different brightness and pixels.



Next press of KEY_OK show a border at the last pixel position.

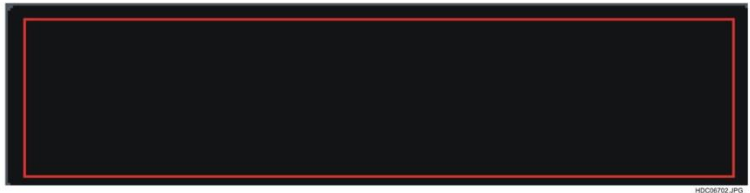

Next press of KEY_OK show brightness setting menu. User can select brightness with KEY_PLUS and KEY_MINUS.



11.3.6 DOORLOCK TEST (ONLY FOR PYRO MODELS)

Next press of KEY_OK starts the locking of door.

If telescopic runners are detected, display shows first WINDOW_23. The telescopic runners have to be removed to continue the door lock test. The door lock process starts automatically after the telescopic runners were removed.

After successfully door lock the door is unlocked again.

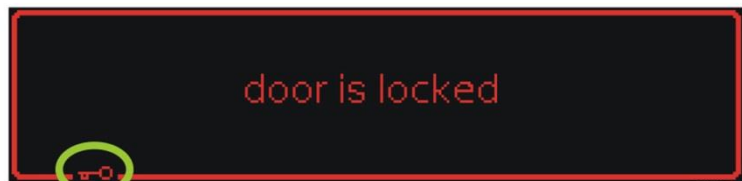

KEY SYMBOL

After that the factory test is done and display shows an end message.



After this last item the oven has to be disconnected from the mains.

12. ALARM CODE

To identify on which place a failure occurred the first value shows the failure place, described at following schematic:

FXXX

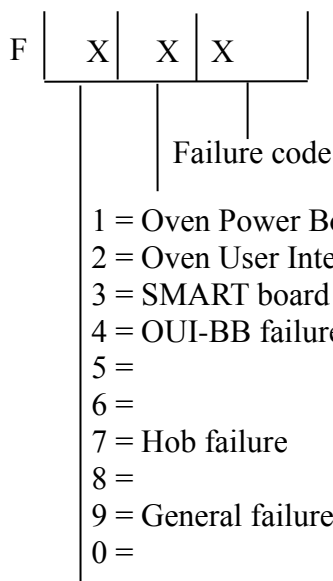

F = Failure

Cx → for customer errors / failures

Error Display	Possible Failure	Action to solve
C1	Telescopic runner inside during pyrolyse	Remove side grids during pyrolyse
C2	Meat probe inside during pyrolyse	Remove Foodprobe during Pyrolyse
C3	Door open during pyrolyse	Close door during pyrolyse
F101	Doorlock sensor problem	Check wiring Check doorlock system Check powerboard
F102	Doorlock failure	Check wiring Check doorlock system Check powerboard
F104	Oven temperature sensor (PT500) out of range	Check wiring Check temperature sensor Check powerboard
F105	Oven temperature sensor (PT500) has too hightemperature	Check temperature sensor Check wiring
F106	Electronic temperature sensor out of range	Check Powerboard Check wiring
F109	Software of user interface and powerboard notfirt together	Check software version and compare with sparepart software
F111	Foodprobe sensor out of range	Check Foodprobe Check wiring Check Foodprobe module
F112	steam sensor out of range	Check Powerboard Check wiring
F113	OVC2000 Ozillator failure	Check Powerboard
F130	Triac failure	Check motors Check Powerboard Check wiring
F131	Temperature sensor of steam generator out ofrange	Check wiring Check temperature sensor Check powerboard
F132	Software expecting oven with door lock,wrong software programmed	Check programming of UserInterface Contact quality department
F133	The init or write or read process on the flash failed	Check Powerboard
F134	Reference voltage of the analog digital converter is out of range	Check Powerboard
F135	Incorrect voltage at door lock relay at oventemperature over 380°C	Check Powerboard
F136	Missing or damaged foodprobe module	Check software version and compare with sparepart software Check FP module Check wiring
F137	Missing or incorrect communication between powerboard and Foodprobe module	Check wiring Check FP module Check powerboard

F138	Oven temperature sensor is fixed on one resistor value	Check Powerboard Check temperature sensor
F140	Wrong configured cooking fan	Check software version and compare with sparepart software
F142	Water level sensor (NTC) in steamer out of range. This Fault appears in case the steam generator is overheated because the water refilling to the system is prevented.	Check the Tubes are clogged Check the Tubes assembly Check the Descaling actuator is closed Check the Inlet valve functioning Check the Ambient temperature where the appliance is placed (it should not be too low)
F143	Humidity sensor out of range	Check if sensor is powered on in correct way Check the Wiring
F191	Oven temperature sensor (PT500) out of range (Warning)	Check wiring Check temperature sensor Check powerboard
F192	Foodprobe temperature value too high	Check wiring Check foodprobe sensor and/or food probe connection box Check Foodprobe module
F193	Humidity sensor out of range warning	Check if sensor is powered on in correct way Check the Wiring
F194	Oven temperature sensor (PT500) out of range (Warning)	Check wiring Check temperature sensor Check powerboard
F195	Electronic temperature value too high	Check Powerboard
F196	Electronic temperature value out of range (warning)	Check Powerboard
F197	Water level sensor (NTC) in steamer out of range.	Check the Tubes are clogged Check the Tubes assembly Check the Descaling actuator is closed Check the Inlet valve functioning Check the Ambient temperature where the appliance is placed (it should not be too low)
F203	Programming not correct	Check software version and compare the sparepart software Check User Interface
F208		
F214	Configuration does not match to firmware of user interface	Check software version and compare with sparepart software
F215	Unexpected content of configuration	Check software version and compare with sparepart software Contact quality department
F233		
F239	No communication between user interface and	Check User Interface

	touch electronic	Check touch electronic
F241	Function selector is not connected	Check wiring Check oven knob Check hexagon user interface
F321	Oven temperature is too high to start Smart function	Check wiring Check temperature sensor Check powerboard
F322	Incorrect temperature value between Powerboard and Smart electronic	Check wiring Check electronic "Smart" Check powerboard
F323	Configuration failure of Smart electronic	Check software version and compare with sparepart software Check User Interface Check electronic "Smartboard"
F324	Unknown state of Smart electronic	Check electronic "Smart"
F325	Flash memory failure	Check electronic "Smart"
F326	Calibration of Smart electronic not finished	Check electronic "Smart"
F327	Error in microcontroller of Smart electronic	Check electronic "Smart"
F329	Analog digital converter error of Smart electronic	Check electronic "Smart"
F406	Electronic temperature sensor out of range	Check the Power board Check the Temperature sensor Check PCIII
F408	Missing communication between powerboard and user interface	Check Wiring Check the Power board Check PCIII
F439	No communication between user interface and touch electronic	Unplug and Replug the appliance Check the interface between UI and the Panel Glass Check PCIII
F493	Alarm is triggered if there is a fault in the backlight driver module	Unplug and Replug the appliance Check PCIII
F494	Alarm is triggered if there is a fault in the RTC	Unplug and Replug the appliance Check PCIII
F495	Alarm is triggered when there is a powerfail in the wiring	Check the mains and power supply Check Wiring Check the Power board
F497	Humidity sensor not working or out of range	Check Wiring Check the Humidity sensor
F716	In oven function pyro the hob is in ON_State	Check software version and compare with sparepart software check wiring
F718	Missing communication between oven user interface and hob user interface	Check wiring
F908	Missing communication between powerboard and user interface	Check wiring Check User Interface Check powerboard

F908	Missing communication between user interface and powerboard	Check wiring Check User Interface Check powerboard
F917	Maximum power limitation problem between oven and hob	Check software version and compare with sparepart software Check wiring Contact quality department
F928	Missing communication between Smart electronic and oven user interface	Check wiring Check electronic "Smart"

13. SIDEKICK

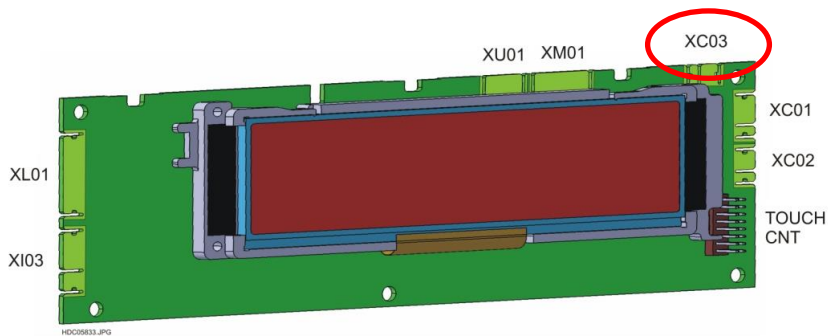

- XC01 MACS BUS FOR POWER BOARD
- XC02 AUXILIARY MACS BUS
- XC03 MACS BUS FOR SIDEKICK (SERVICE)
- XI03 DIGITAL ROTARY BIT ENCODER AND INPUT BLOCK
- XL01 TOUCH BOARD BACKLIGHT
- XM01 PROGRAMMING FLASH MEMORY
- XU01 PROGRAMMING
- TOUCH CNT INPUT TOUCH BOARD (15 PIN)

14. REVISIONS:

Revision	Date	Description	Author	Approved by - on
00	03/2015	Document Creation	BSP	