

© Electrolux Home Products Italy S.p.A.

Corso Lino Zanussi, 30
I - 33080 Porcia – PN -

Fax: + 39 0434 394096

SOI

Edition: 03-2008 Rev 0.0

Publication
number

599 70 66 79

EN

**Condenser dryer
with heat pump**

ENV06 AEG HP

**Versions
with and without LCD**

TABLE OF CONTENTS

1	Introduction.....	4
1.1	Purpose of this manual.....	4
1.2	Caution.....	4
1.3	Installation.....	4
2	Technical characteristics.....	5
2.1	Technical data.....	5
2.2	Circuit boards.....	5
3	Control panel.....	6
3.1	Stylings.....	6
3.2	Programme selector.....	6
3.3	Keys.....	7
3.4	Symbols on models with LCD.....	8
3.5	Child safety function.....	9
3.6	Delicate fabrics (½ power).....	9
3.7	Adjusting the spin speed.....	9
3.8	DELAYED-START key – models with LCD.....	10
3.9	DELAYED-START key – models without LCD.....	10
3.9.1	Disactivate buzzer.....	11
3.9.2	Disactivate buzzer (not only for the selected cycle).....	11
3.10	START / PAUSE key.....	11
3.11	Adjusting the level of conductivity.....	12
3.11.1	Procedure.....	12
3.11.2	Display.....	13
3.12	Warning LEDs and symbols.....	14
4	Operation of the appliance.....	15
4.1	Operation of a cycle.....	15
4.2	Operation in PAUSE mode.....	15
4.3	Operation in DELAYED START mode.....	16
4.4	Power failure.....	16
5	Structural characteristics.....	17
5.1	Heat pump in drying circuit: operating principles.....	17
5.2	Structural components.....	19
5.3	Drum.....	20
5.4	Air seal and drum spindle support.....	20
5.5	Hydraulic circuit.....	21
5.6	Drum rotation: principles.....	21
6	Electrical components.....	22
6.1	Electronic control system.....	22
6.1.1	Main circuit board: functions.....	22
6.1.2	Electronic control system memory: general structure.....	23
6.2	Conductimetric sensor.....	24
6.3	Terminal block with suppressor.....	24
6.4	Compressor.....	25
6.5	PTC motor protector.....	25
6.6	Motor compressor capacitor.....	25
6.7	Fan cooling compressor.....	26
6.8	Drum motor.....	26
6.9	Drum motor capacitor.....	26
6.10	Canister fill pump.....	27
6.11	Air circulation fan.....	27
6.12	Fan motor capacitor.....	27
6.13	NTC sensor.....	28
6.14	Door switch.....	28
6.15	Door interlock.....	28
7	Circuit diagram.....	29
8	Diagnostics system.....	30

8.1	Access to diagnostics	30
8.2	Exiting the diagnostics system	31
8.3	Selector positions for diagnostics (conductimetric appliances).....	32
9	Alarms	34
9.1	Displaying the last alarm to the user	34
9.2	Displaying alarms during normal operation	34
9.3	Reading the alarms.....	34
9.3.1	Displaying the alarms: models with LCD	34
9.3.2	Displaying the alarms: models without LCD	34
9.3.3	Displaying other alarms	35
9.3.4	Cancelling the last alarm.....	35
9.3.5	Notes concerning alarm conditions E93, EH1, EH2 and EH3.....	35
9.4	Table of alarms	36
10	The diagnostics cycle does not start	39
10.1	None of the LEDs on the display board lights.....	39
	Some of the LEDs on the display board light.....	40
11	Access to components	41
11.1	Door.....	41
11.2	Fluff filter.....	41
11.2.1	Fluff filter on door	41
11.2.2	Lower fluff filter.....	41
11.2.3	Evaporator fluff filter.....	42
11.2.4	Fluff filter for water from evaporator.....	42
11.3	Compressor for fan motor	43
11.4	Door lock	43
11.5	Door microswitch.....	43
11.6	Door lock latch - Door microswitch latch	44
11.7	Drum light bulb	44
11.8	Canister	44
11.9	Work top	45
11.10	Control panel/support assembly.....	45
11.11	Main circuit board	46
11.11.1	Removing the board	46
11.11.2	Removing the selector knob spindle	46
11.11.3	Removing the selector knob	46
11.11.4	Key spring strip	46
11.12	Side panels.....	47
11.13	Water ducts	47
11.14	Condensation pump / float-actioned switch	48
11.15	Drum rotation motor	49
11.16	NTC heat pump circuit.....	49
11.17	Drum brush.....	50
11.18	Rear brush.....	50
11.19	Rear air duct.....	51
11.20	PTC and motor overload cut-out.....	51
11.21	Dismantling the chassis for servicing.....	52
11.22	Air duct	53
11.23	Front air seal	53
11.24	Idle pulleys	53
11.25	Rear air seal	53
12	Checking the efficiency of the heat pump	54
12.1	Servicing the heat pump circuit.....	57
12.1.1	Replacing the compressor	57
12.1.2	Evacuation	57
12.1.3	Filling.....	57
13	Door reversibility	58

1 Introduction

1.1 Purpose of this manual

The purpose of this Service Manual is to provide service engineers who already have basic experience in repairing clothes dryers with additional technical information concerning condenser dryers with electronic control systems.

The electronic control system consists of a main circuit board with a built-in selector and - on some models - a liquid-crystal display (LCD). These components are supplied already assembled and tested by the manufacturer.

This Service Manual describes the following:

Technical characteristics
Control panel
Description of operation
Structural characteristics
Electrical components and circuit diagrams
Diagnostics
Alarms
Accessibility

1.2 Caution

 WARNING	<ul style="list-style-type: none">• Any repairs or maintenance of electrical appliances must be carried out by qualified persons only.• Always remove the plug from the power socket before accessing the internal components.
---	---

1.3 Installation

The appliance must be installed on a perfectly flat, level surface in order to ensure that the condensation produced during the drying process is ducted correctly to the special canister.

The feet should never be removed. There must always be a space between the bottom panel of the dryer and the floor in order to prevent possible overheating.

 WARNING	If the appliance is laid on its side for maintenance or repairs, wait for ½ hour before operating it again.
--	---

2 Technical characteristics

2.1 Technical data

Dimensions	<ul style="list-style-type: none"> ▪ height: 85 cm ▪ width: 60 cm ▪ depth: 58 cm 	
Voltage	<ul style="list-style-type: none"> ▪ volts: 220-240 ▪ Hz: 50/60 	
Number of keys	▪ varies depending on the model	
Number of LEDs	▪ varies depending on the model	
Type of display panel	<ul style="list-style-type: none"> ▪ small LCD on TC2 models ▪ large LCD on TC3 models 	
Acoustic signalling device	▪ built-in buzzer on circuit board	
Serial port	▪ DAAS-EAP communications protocol up to 230400 baud	
Programme selector	<ul style="list-style-type: none"> ▪ 11 positions (models without LCD) ▪ 15 positions (models with small LCD) ▪ 21 positions (models with large LCD) 	All models feature a built-in ON/OFF switch
Drying system	▪ condensation of humidity with heat exchanger	
Humidity control	▪ conductimetric sensor	
Motor	▪ single-phase asynchronous with capacitor	
Heating unit	▪ heat pump	
Gas for heat pump	▪ R134a 270g	
Temperature control	▪ NTC sensor	
Capacity of canister	▪ 4 litres approx.	
Canister fill pump	▪ with synchronous motor	

2.2 Circuit boards

The electronic control system consists of a main circuit board with a built-in selector and - on some models - a liquid-crystal display (LCD). These components are supplied already assembled and tested by the manufacturer.

The boards shown in the figures below may differ slightly from those actually fitted to the appliance.

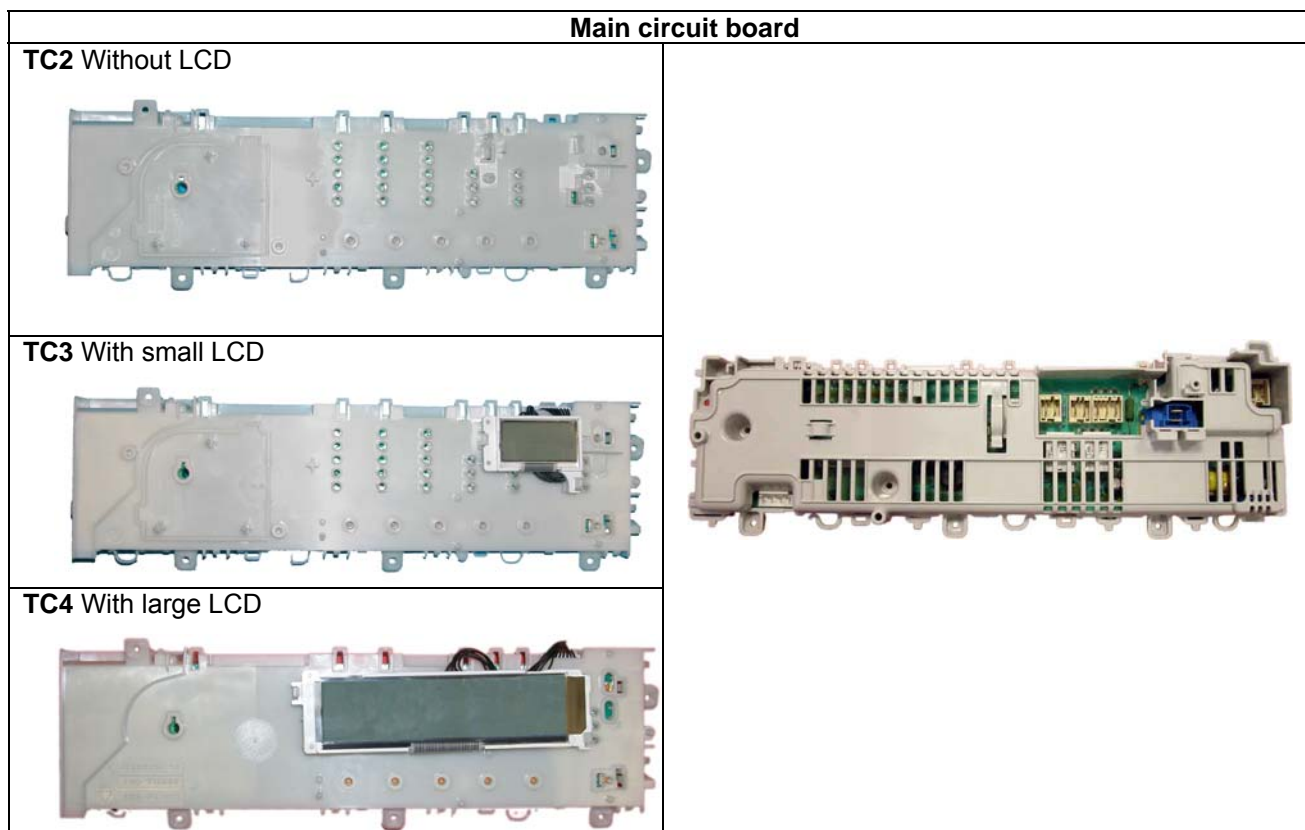

3 Control panel

3.1 Stylings

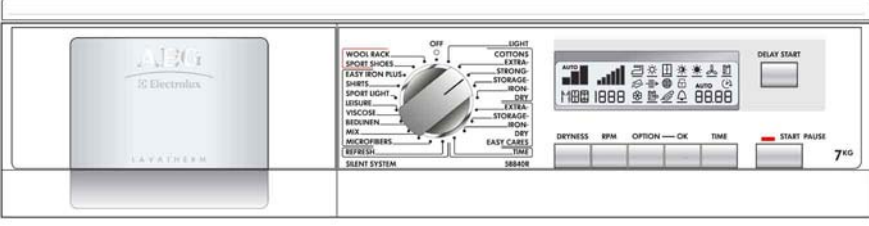
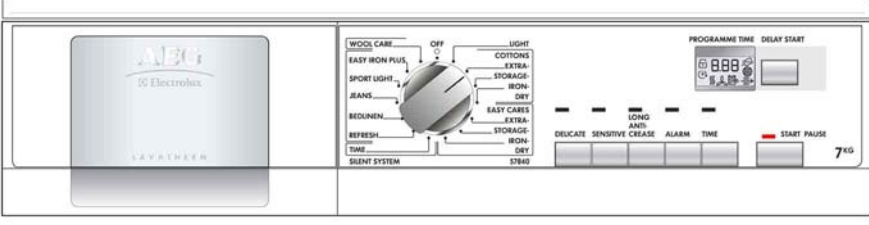
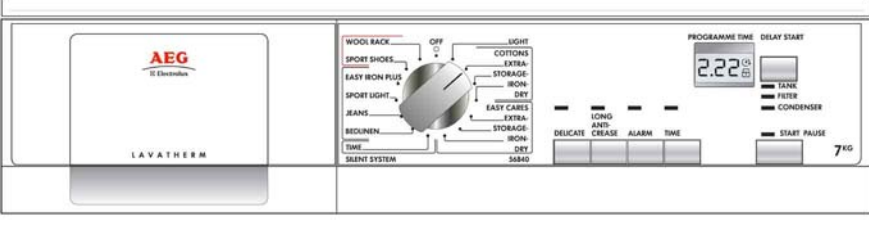
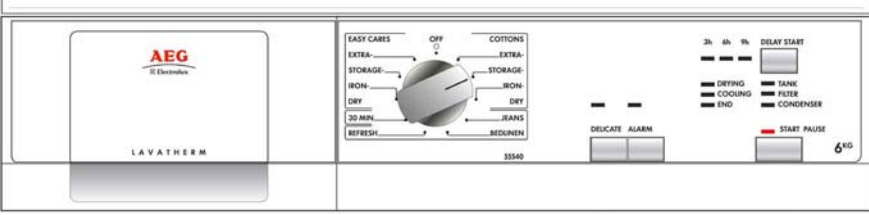
 <p>The image shows the control panel for model TC2. It features a large LCD display on the right side showing various icons and numbers. The rotary selector is positioned in the center, with 21 positions labeled around it, including 'WOOL CARE', 'EASY IRON PLUS', 'SPORT LIGHT', 'JEANS', 'BEDLINEN', 'REFRESH', 'TIME', 'SILENT SYSTEM', 'OFF', 'COTTONS', 'EXTRA STORAGE', 'IRON DRY', 'EASY CARES', 'IRON DRY', and 'EASY CARES'. Below the display are buttons for 'DRYNESS', 'SPIN', 'OPTION', 'OK', 'TIME', and 'START PAUSE'. The AEG logo and 'LAVATHERM' are on the left.</p>	<p>TC2 Large display</p>
 <p>The image shows the control panel for model TC3 with a small LCD display. The display shows '888' and some icons. The rotary selector has 15 positions. Buttons below the display include 'DELICATE', 'SENSITIVE', 'CREASE', 'ALARM', 'TIME', and 'START PAUSE'. The AEG logo and 'LAVATHERM' are on the left.</p>	<p>TC3 Small display With information on display</p>
 <p>The image shows the control panel for model TC3 with a small LCD display. The display shows '2.22' and some icons. The rotary selector has 15 positions. Buttons below the display include 'DELICATE', 'SENSITIVE', 'CREASE', 'ALARM', 'TIME', and 'START PAUSE'. The AEG logo and 'LAVATHERM' are on the left.</p>	<p>TC3 Small display Without information on display</p>
 <p>The image shows the control panel for model TC4, which does not have a display. The rotary selector has 11 positions. Buttons below the selector include 'DELICATE', 'ALARM', and 'START PAUSE'. The AEG logo and 'LAVATHERM' are on the left.</p>	<p>TC4 Without display</p>

3.2 Programme selector

Models without LDC (TC4) are fitted with 11-position programme selectors. On models with small LCD (TC3), the selector has 15 positions. Large-LCD models (TC2) have 21 positions.

All models feature a built-in ON/OFF switch on the circuit board.

The symbols refer to the various drying cycles that can be selected for COTTON, SYNTHETIC FABRICS, SILK and WOOL.

All programme positions can be configured depending on the model.





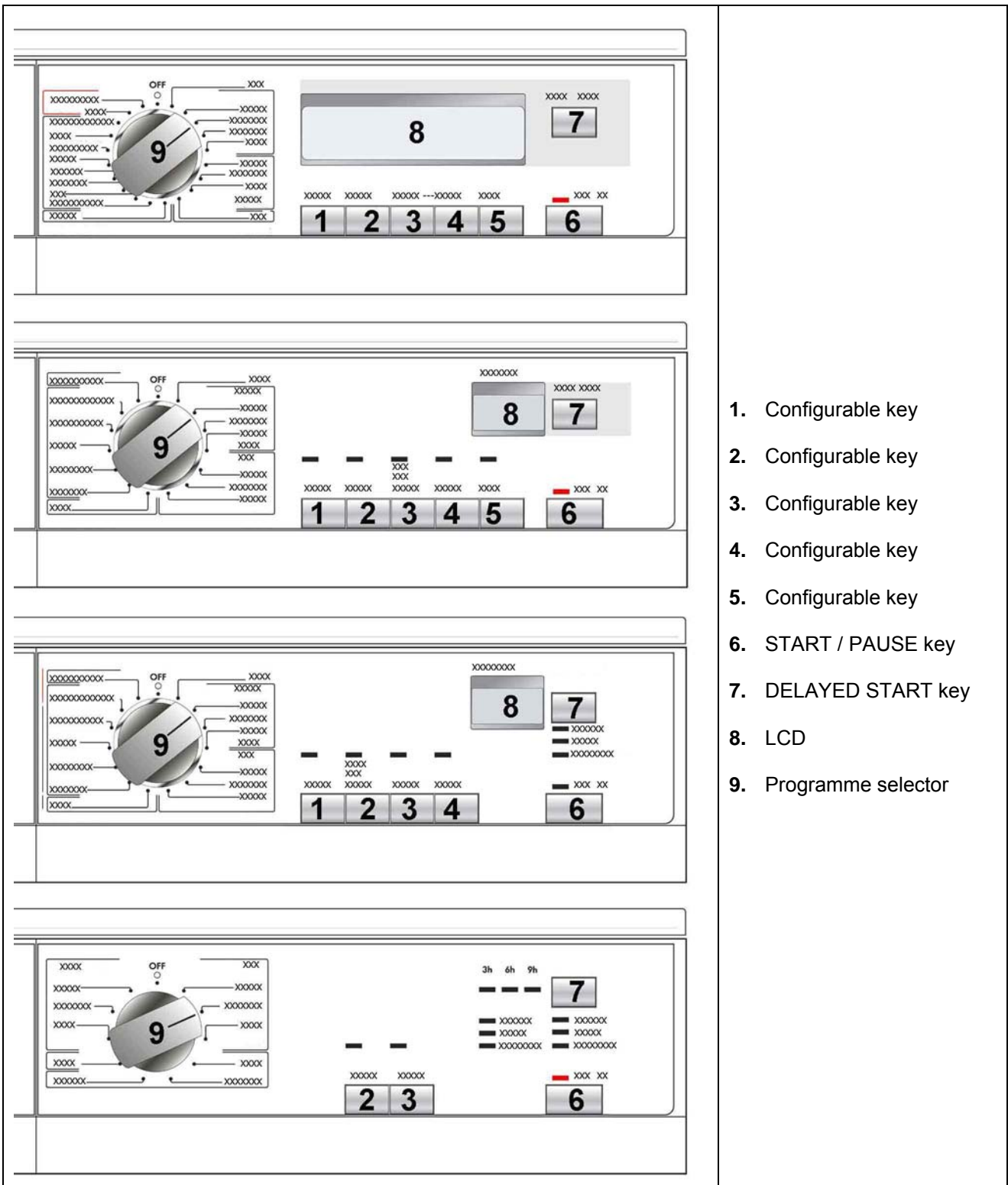

3.3 Keys











1. Configurable key
2. Configurable key
3. Configurable key
4. Configurable key
5. Configurable key
6. START / PAUSE key
7. DELAYED START key
8. LCD
9. Programme selector

3.4 Symbols on models with LCD





Cycle option symbols

	Delicate		Long anti-crease cycle
	Sensitive		Spin speed
	Final humidity		



Cycle symbols

	Iron-ready		Cupboard dry
	Light drying		Strong drying
	Extra-strong drying		Drying phase
	Cooling phase		Anti-crease phase

Alarms

	Empty condensation canister		Clean filters
	Clean heat exchanger		Child safety function
	Buzzer		

Timer

	Delayed start		Time-to-elapsed/Alarm code
---	---------------	---	----------------------------

3.5 Child safety function

For all models: To enable the child safety function, press keys 3 and 4 simultaneously and hold them down for 5 seconds. All the keys will be disabled and no further modifications can be entered. To deactivate this function, press the same keys again for 5 seconds.

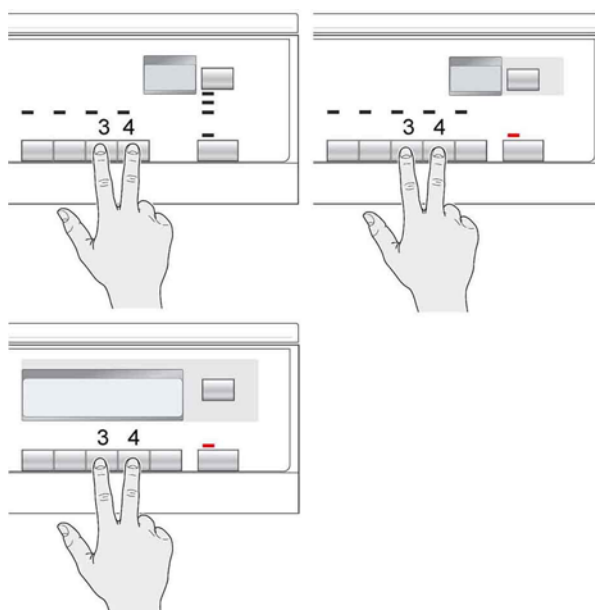

3.6 Delicate fabrics (1/2 power)

The dryer is fitted with a heating unit consisting of two heating elements having different power ratings (which depend on the model).

When this key is pressed once, the electronic control system switches off the low-power branch of the heating unit, and the corresponding LED lights to indicate that this option has been selected.

If the same key is pressed again, the LED will switch off to show that the option has been deactivated, and the low-power branch of the heating element will switch on again.

3.7 Adjusting the spin speed

This adjustment procedure tells the electronic control system that the wash load has been spin-dried at a certain speed and will therefore have a certain level of humidity.

In certain programmes, this value modifies the time required for the final drying phase.

Each time the key is pressed, the spin speed increases by 200 rpm, from a minimum of 800 rpm to the maximum speed for the programme selected (the absolute maximum spin speed is 1,800 rpm).

To reset the spin speed to zero, continue to press this key until "0" is displayed.

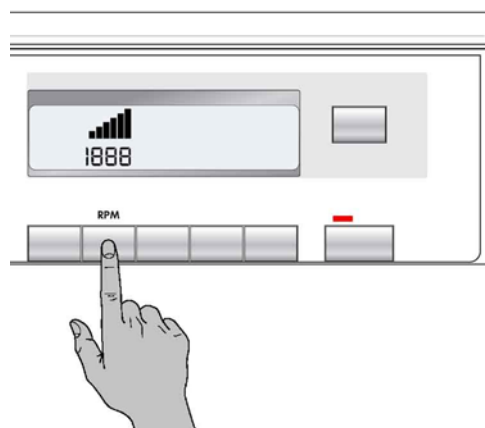

3.8 DELAYED-START key – models with LCD

Press this key during the programme selection phase (set-up) to select the DELAYED START function.

On models with LCD, the delayed-start time varies up to a maximum of 20 hours. The time is shown on the display.

Each time the key is pressed, the delayed-start time increases as follows:

- For the first two hours: at intervals of ½ hour.
- After the initial two hours: at intervals of 1 hour.
- To reset the delayed start time, either move the selector by one position or press the key until the time on the display returns to zero.

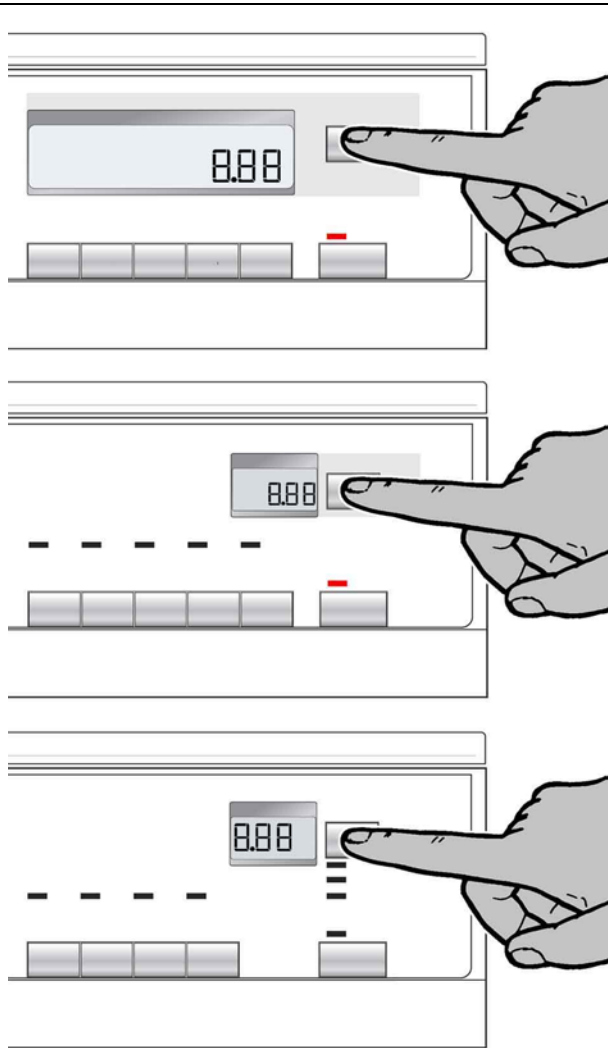

3.9 DELAYED-START key – models without LCD

On models without LCD, the delayed start time varies up to a maximum of 9 hours.

Press the DELAYED-START key until the LED corresponding to the desired time lights.

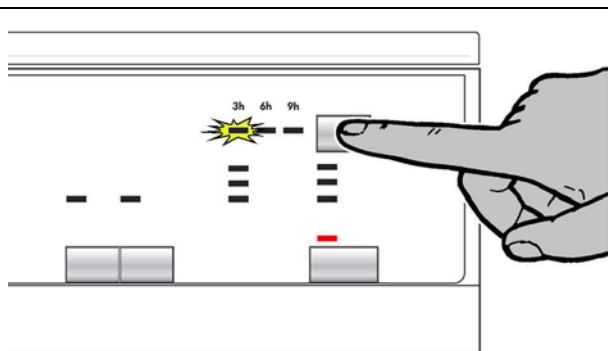

3.9.1 Deactivate buzzer

The buzzer may be deactivated while the dryer is in programme selection (set-up) mode.

Press this key to enable the buzzer. The corresponding LED or symbol will light to indicate that the buzzer is on. To disable this option, press the same key again.

The buzzer will continue to sound in the event of an alarm even if the normal buzzer function has been disabled.

3.9.2 Deactivate buzzer (not only for the selected cycle)

This function should be selected during the selection (set-up) phase.

Valid for all models: Press keys **1** and **2** simultaneously for 5 seconds. The LED or symbol corresponding to the buzzer will switch off and a "BIP" will be heard

To re-activate the buzzer, press the same keys again until the buzzer again sounds a "BIP".

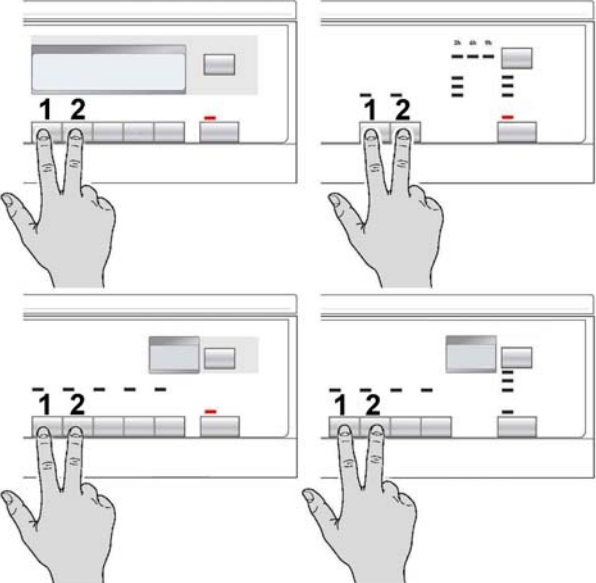

3.10 START / PAUSE key

▪ Start

When the selector is used to select a drying programme, the symbols for the three phases (drying, cooling and anti-crease) light and the START/PAUSE LED begins to flash.

After selecting the desired options (if any), press this key to start the cycle. The corresponding LED will remain lit.

▪ Pause

If a drying cycle is being performed, it can be interrupted by pressing START/PAUSE. The appliance goes into PAUSE mode and the corresponding LED begins to flash.

Press START/PAUSE to resume the drying cycle from the point at which it was interrupted.

3.11 Adjusting the level of conductivity

The so-called "conductivity" of the water used to wash the fabrics varies in different areas. The conductivity sensor is calibrated for a standard value, and any significant variations in the level of conductivity may affect the final drying result (fabrics too dry or too damp).

These variations are especially noticeable in the "slightly damp" and "iron dry" cycles. The "cupboard dry" cycle is almost unaffected by variations in conductivity.

3.11.1 Procedure

To enter adjustment mode:

1. Turn the programme selector to switch on the appliance.
2. In selection (set-up) mode, press the following keys simultaneously:
 - 1 and 5 in models with large LCD
 - 1 and 5 in models with small extended LCD
 - 1 and 4 in models with small LCD and ALARM LEDs
 - 1 and 3 (START/PAUSE) in models without LCD
3. Hold the keys down until the buzzer sounds (about 5 seconds).

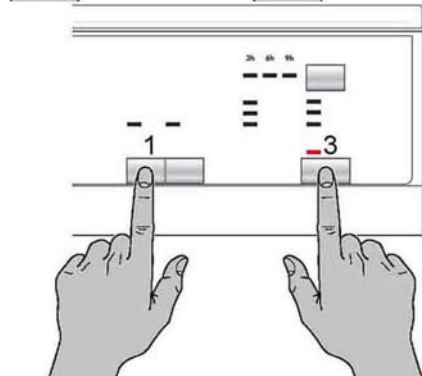
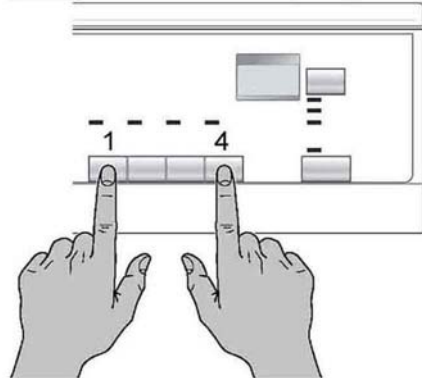
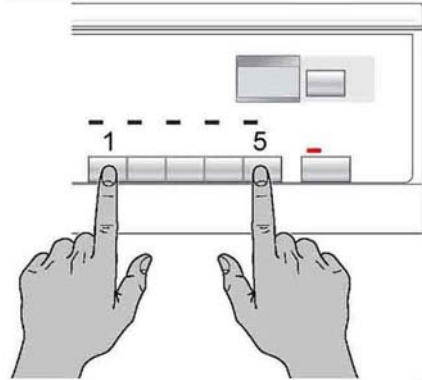
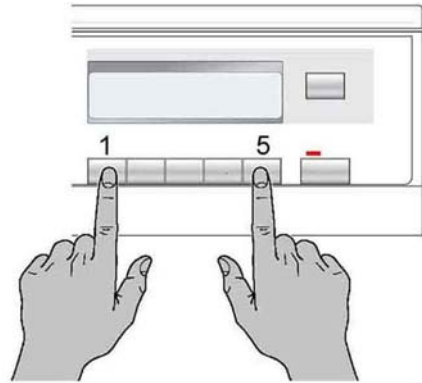





To adjust the level of conductivity:

Press the START/PAUSE key: the level of conductivity is varied each time the key is pressed. The level is indicated by the lighting of the LEDs or the horizontal segments of the final digit.

To store this level in memory:

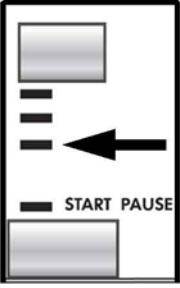
1. Press the same keys as above.
2. Hold both keys down until the buzzer sounds (about 5 seconds).

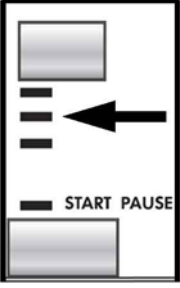
3.11.2 Display

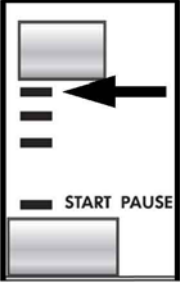
Display / LED	Level of conductivity	Approximate value ($\mu\text{S}/\text{cm}$)
DISPLAY  LED 	LOW	< 300
DISPLAY  LED 	AVERAGE	300 – 600
DISPLAY  LED 	HIGH	> 600

The appliance is generally factory-set to the average level, though certain models may be configured differently.

Check with your local Water Board office to determine the level of conductivity of the mains supply in your area.

3.12 Warning LEDs and symbols



L1 or **Clean heat exchanger:**

Lights after 80 drying cycles.

To reset the cycle counter (for this function), open the access panel while the dryer is switched on, remove and clean the heat exchanger. Replace the heat exchanger and close the access panel.



L2 or **Clean filter**

Lights at the end of the drying cycle to warn the user that the filter requires cleaning.



L3 or **Canister full**

Lights during the course of the drying cycle if the electronic control system detects that the floating microswitch has closed or at the end of the cycle, to indicate to the user that the canister must be emptied.

L4 **Start / Pause**

Flashes (green) when the cycle is in pause mode, or lights green (fixed) while the cycle is being performed. If any of the alarm conditions has been detected, the buzzer will sound three "beeps" twice within a few seconds, and this LED will begin to flash (red).

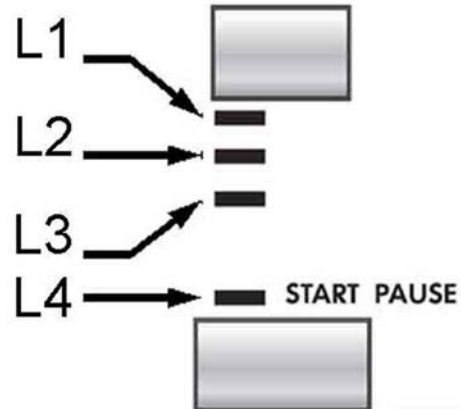

4 Operation of the appliance

When the selector switch is turned from OFF to one of the drying programmes, the symbols or LEDs corresponding to the drying phases light and the START/PAUSE LED begins to flash.

During this phase, the various options can be entered (the corresponding symbol(s) will light).

The display shows the maximum time for the drying cycle.

If an option is selected that is incompatible with the programme, the buzzer sounds and the display shows "Err". The LEDs begin to flash.

If one or more options are entered, the time shown on the display will increase or decrease.

If the position of the selector is altered after entering the options, but before pressing START/PAUSE, the options will be cancelled.

4.1 Operation of a cycle

To start the drying cycle, first use the selector to enter a drying programme. Then enter the desired option (if any), and press START/PAUSE.

The LED corresponding to the START/PAUSE key remains lit and, simultaneously, the symbol corresponding to the current phase lights. The display shows the maximum drying time.

The drying cycle comprises the following phases:

- **DRYING**

If an automatic cycle has been selected, the duration will be the time required to remove the humidity until the desired humidity level is reached.

If the cycle is timer-controlled, then its duration will be the time entered by the user.

- **COOLING**

For timer-controlled cycles, the cooling phase has a maximum duration of 10 minutes. For automatic cycles, the duration of the cooling phase may be shorter (this depends on the temperature inside the drum).

- **ANTI-CREASE**

The duration of the anti-crease phase is 30 minutes.

The programme may not be modified after a drying programme has commenced.

If the position of the programme selector is changed, the LED corresponding to the START/PAUSE key begins to flash and the buzzer sounds to warn the user that the operation is not compatible. "Err" is shown on the display.

If any key is pressed, the LED corresponding to the START/PAUSE key begins to flash and the buzzer sounds to warn the user that the operation is not compatible. "Err" is shown on the display.

The options permitted for each cycle can be entered only after selecting the drying programme with the selector at the start of the cycle, or during a cycle but after pressing the START/PAUSE key.

To reset (cancel) a drying cycle, turn the selector to OFF.

4.2 Operation in PAUSE mode

If the START/PAUSE key is pressed while a dryer cycle is being performed, the dryer interrupts the cycle and the LED corresponding to the START/PAUSE key flashes. In models with display, the time-to-elapsed until the end of the cycle is shown.

If the programme selector is turned, the buzzer will sound to warn the user that this operation is incompatible.

In this status, only certain options can be modified (see table "OPTIONS" in the Instruction Booklet).

If a key is pressed with an option that is not permitted for the programme being performed, the buzzer sounds to warn the user and "Err" is shown on the display.

Press the START/PAUSE key again to resume the cycle at the point at which it was interrupted.

4.3 Operation in DELAYED START mode

After selecting the drying programme, press this key to access the delayed start option. The delay time increases each time the key is pressed.

To cancel (reset) this option, either turn the programme selector by one position or press the DELAYED START key until the time displayed returns to zero. The cycle is started by pressing the START/PAUSE key.

4.4 Power failure

The table below shows how the dryer reacts in the event of a power failure during a drying cycle.

<i>Before the power failure</i>	<i>After the power failure</i>
Programme selection (set-up)	Programme selection (set-up)
Drying cycle	Pause
Cycle paused	Pause
Anti-crease cycle	End of cycle
Delayed start cycle	Delayed start cycle paused
Delayed start cycle paused	Delayed start cycle paused
End of cycle	End of cycle
"Canister full" alarm	"Canister full" alarm

5 Structural characteristics

5.1 Heat pump in drying circuit: operating principles

The cycle performed by the heat pump in a dryer consists of evaporation, compression, condensation and expansion of the liquid coolant (R134a). The circuit contains 270g of coolant.

The coolant is stored in the vaporizer (4) initially in liquid form. The temperature of the air entering from the drum (14) is higher than the boiling point of the coolant. This causes heat to be transferred from the hot air to the liquid coolant, causing it to evaporate. Due to this process of cooling, the humidity contained in the air condenses and the resulting condensation flows into the collector tray (13) and is pumped from the tray to the condensation canister (15).

The compressor (9) constantly draws in the vapour from the liquid coolant, which is compressed several times and, as a result, is heated. The fluid cedes its heat in the condenser (3), which again heats the air drawn in by the fan (2). This air, which is now dry, is again ducted through the drum where it absorbs humidity.

The coolant, which has now resumed its liquid form, loses pressure and temperature via the capillary tube (7) so that, inside the evaporator (13), heat is again absorbed from the humid air coming from the drum (14). The balancing of the entire system is controlled by an NTC sensor located at the outlet of the condenser. This sensor transmits a signal to the electronic control system, which switches on the compressor cooling fan (10).

This cycle is repeated uninterruptedly in a closed circuit.

If water is present in the collector tray (13), the microswitch is tripped, and switches on the condensation pump (12). The pump ducts the water to the canister (15). If the canister is full, any excess water overflows into the tank of the canister, and then back to the collector tray (13) through a hose (not shown in the figure). This moves the float upwards to trip the microswitch again. According to the time (from 15 to 40 seconds - the time necessary for the pump to drain the sump) the electronic control system determines whether the sump has been drained or whether water is overflowing from the canister. In this last case, the electronic control system switches off the appliance and lights the "canister full" LED.

- 2. Fan
- 3. Condenser
- 4. Vaporizer
- 7. Capillary tube
- 9. Compressor
- 12. Condensation pump
- 13. Collector tray
- 14. Drum
- 15. Condensation canister

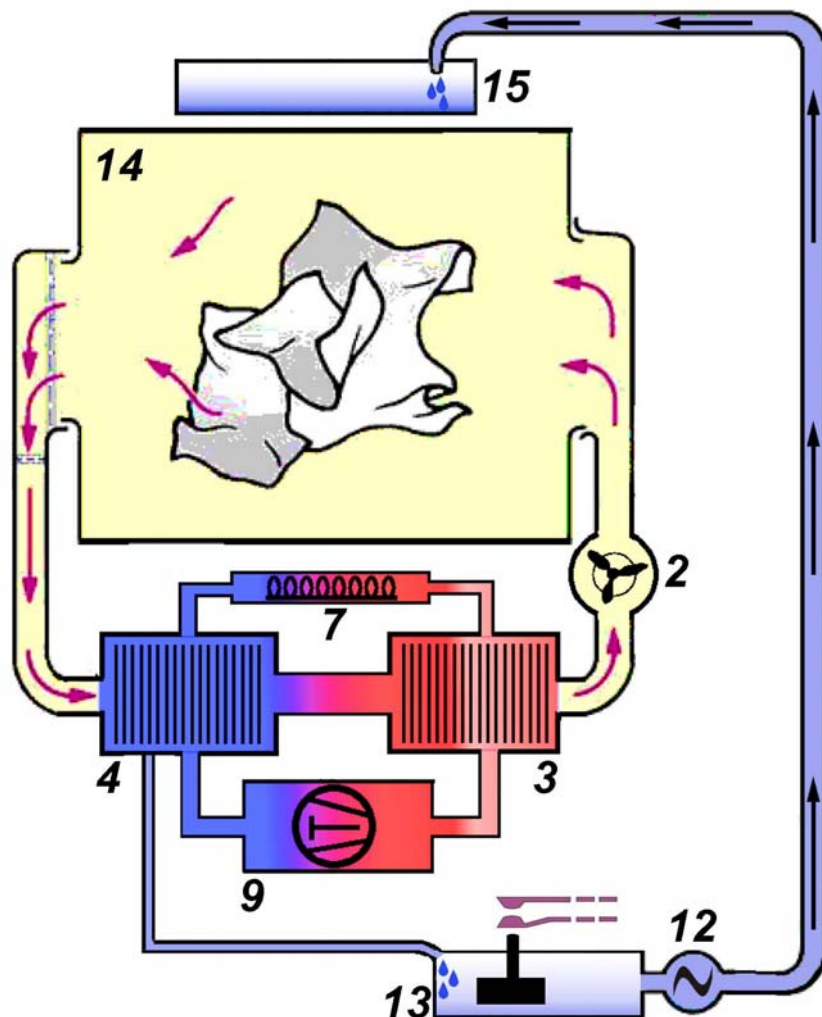

1. Drying air (dry)
2. Fan for air circulation
3. Condenser
4. Vaporizer
5. Fluff filter
6. Humid air

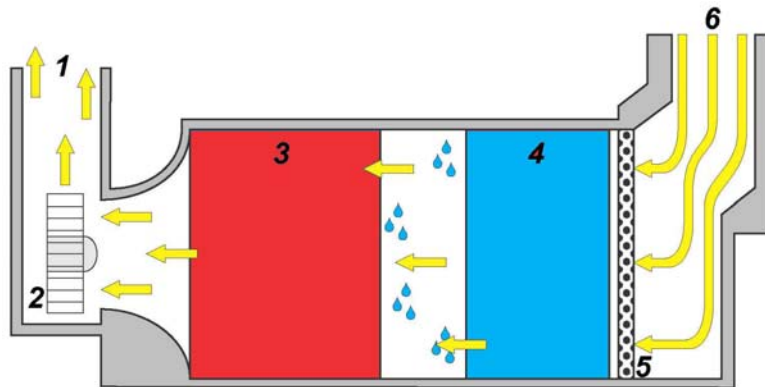

7. Capillary tube
8. Cold, dry air
9. Compressor
10. Compressor cooling fan
11. Drum rotation motor
12. Condensation pump
13. Collector tray for water

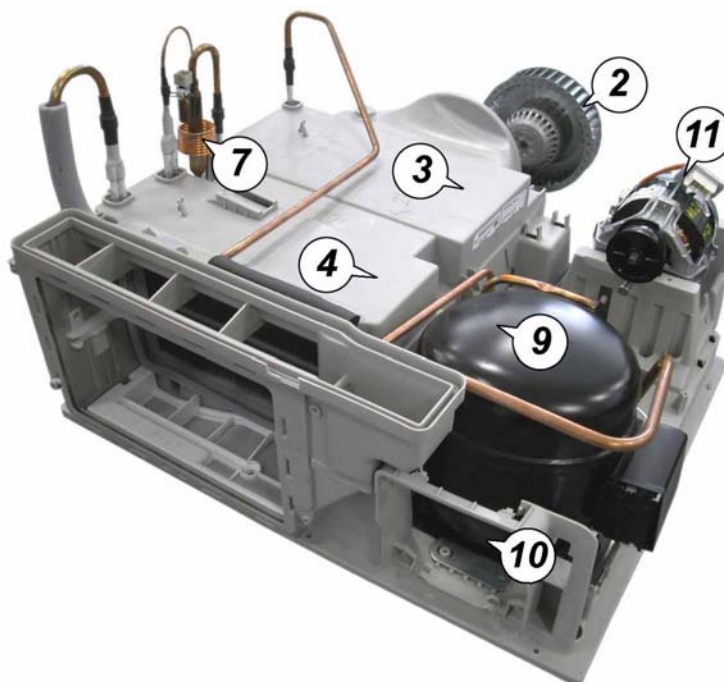
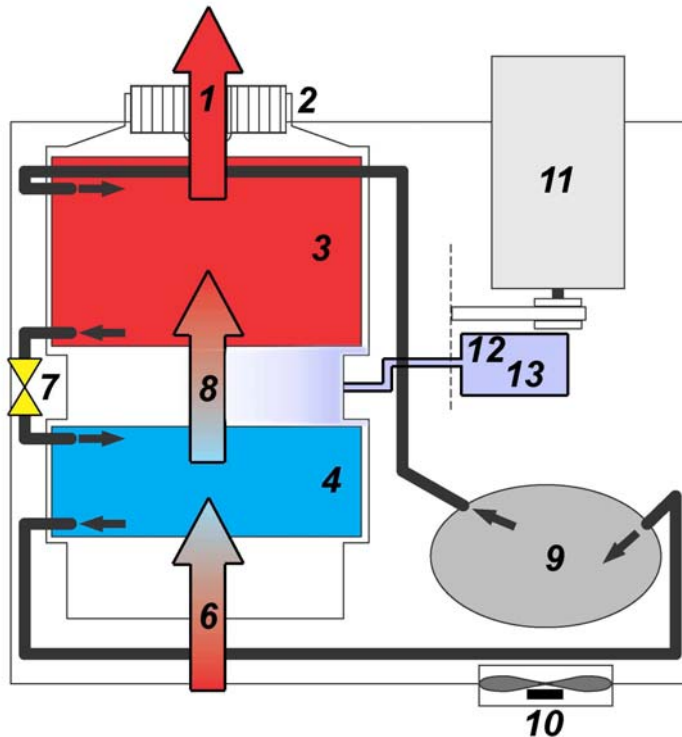

5.2 Structural components

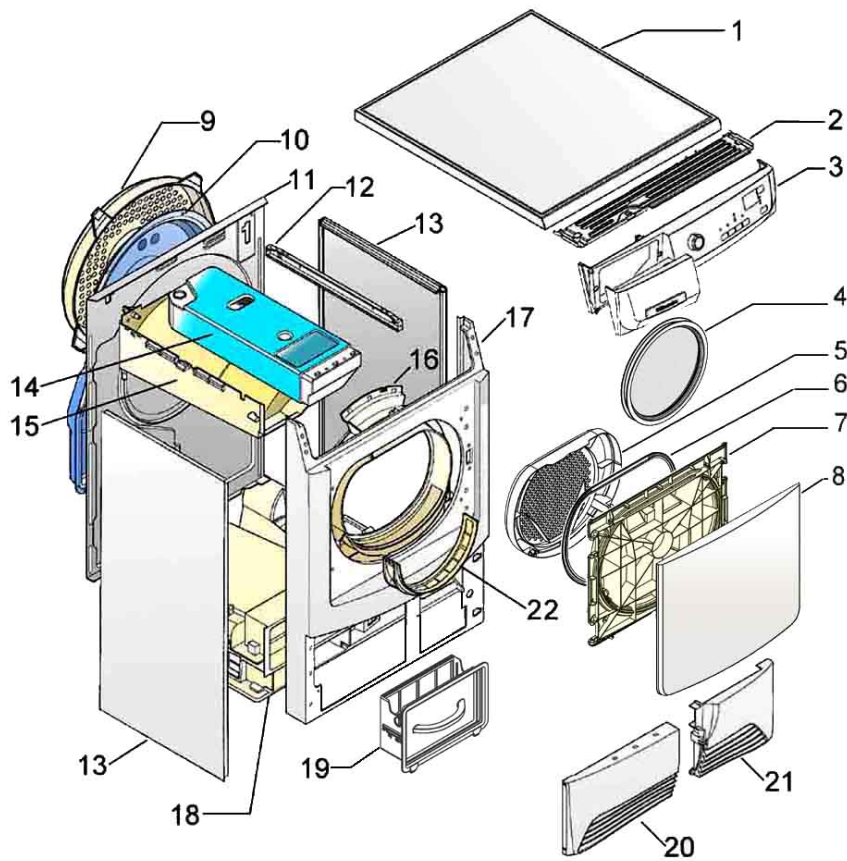

- | | |
|--------------------------------|-------------------------------|
| 1. Work top | 12. Cross-member |
| 2. Control panel support | 13. Side panels |
| 3. Control panel | 14. Canister in upper section |
| 4. Fluff filter | 15. Canister support |
| 5. Fluff filter support | 16. Duct |
| 6. Door seal | 17. Front panel |
| 7. Internal door surround | 18. Base |
| 8. External door surround | 19. Fluff filter |
| 9. Rear panel protective cover | 20. Filter compartment door |
| 10. Rear panel cover | 21. Plinth |
| 11. Rear panel | 22. Front fluff filter |

The front panel and the side panels are in enamelled sheet metal, while the rear panel is in galvanized sheet metal. These panels are secured by self-tapping screws and anchored to the base. The shaped base is in Carboran, and supports the main components.

5.3 Drum

The drum consists of a front flange (1), a rear flange (3), a drum band (2) and three lifters (4) which move the washing when the drum rotates.

In models fitted with conductivity sensors, a central contact band (5) is fitted between the two flanges. Together with the lifters, this band comprises the humidity control system.

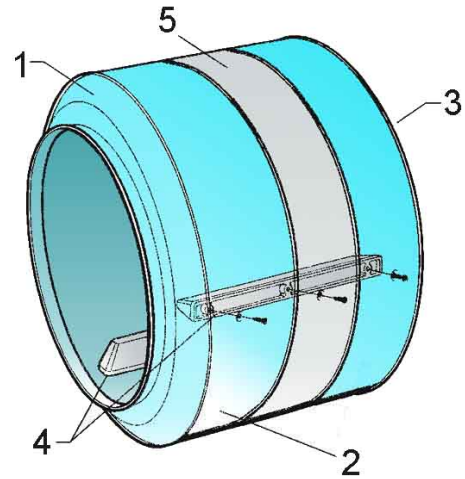

1. Front flange
2. Drum band
3. Rear flange
4. Lifters
5. Brush contact band

5.4 Air seal and drum spindle support

Rear air seal

1. Rear seal (fitted to rear panel)
2. Drum
3. Rear panel

Rear drum support

4. Anti-friction washer
5. Fixing ring (Benzing)
6. Rear panel
7. Drum spindle
8. Support with bushing (fitted to rear panel)

Front drum support and air seal

9. Drum
10. Felt ring with tubular support
11. Duct

Lower drum support

9. Drum
10. Felt ring with tubular support
11. Duct
12. Drum support/rotation roller

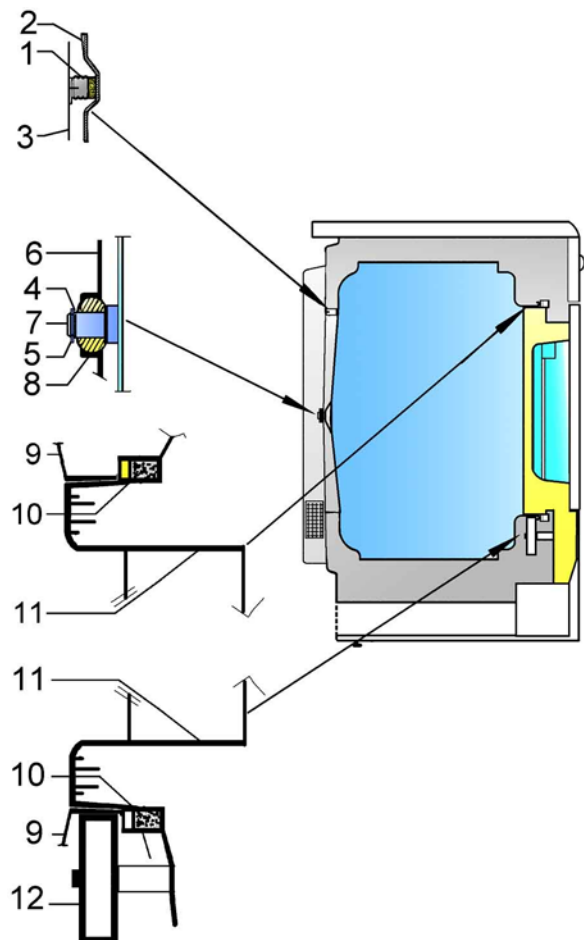

5.5 Hydraulic circuit

1. Water overflow drain tube (transparent)
2. Water fill hose to canister (red)
3. Pump

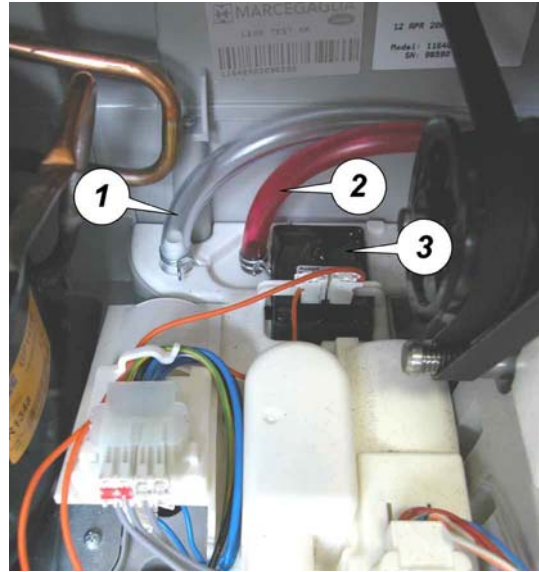

The condensation water coming from the sump is ducted to the canister by the pump (3) (immersed in the sump) through the red tube (2).

When the canister is full, the overflow is ducted through the transparent tube (1) back to the sump.

5.6 Drum rotation: principles

1. Motor
2. Belt tensioner spring
3. Belt tensioner
4. Drive belt

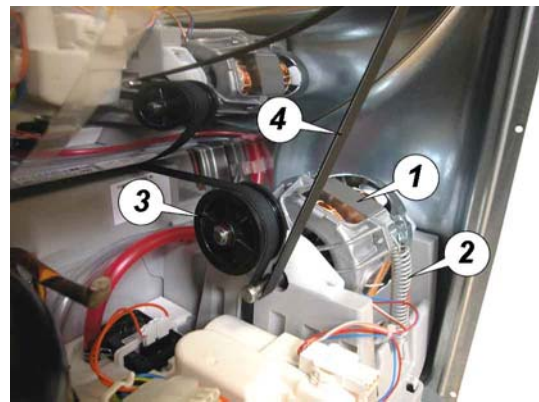

The drum is rotated by a drive belt (4), which is actuated by the pulley of the motor (1), which is anchored to the base of the appliance. The motor casing is fitted with a belt tensioner (3) which operates together with the tensioner spring (2) to increase the winding angle between the belt and the drum.

The bi-directional moment of the drum is controlled by the electronic control system, which inverts the power supply to the motor for brief periods. Reverse rotation of the drum allows the wash load to become untangled. During these brief intervals of reverse rotation, the power supply to the heater is disconnected.

When the access panel is opened to check the heat exchanger, a microswitch is tripped and disconnects the power supply to the appliance.

6 Electrical components

6.1 Electronic control system

The electronic control system comprises a main circuit board, which is inserted inside a plastic housing and fitted behind the control panel support. On models with LCD, this housing also contains the display board.

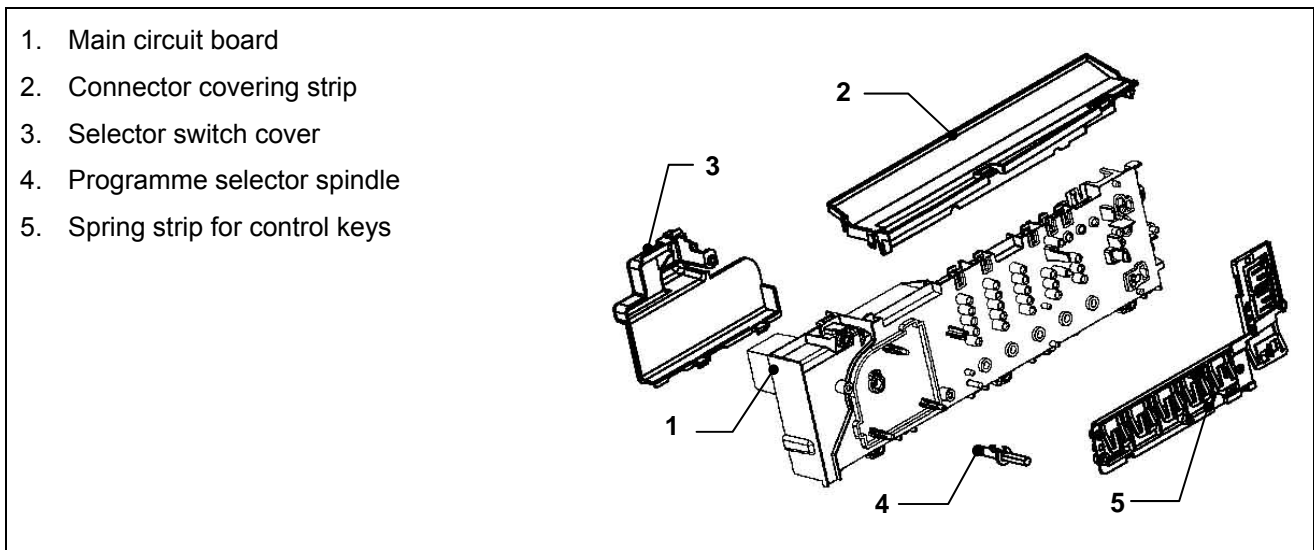

6.1.1 Main circuit board: functions

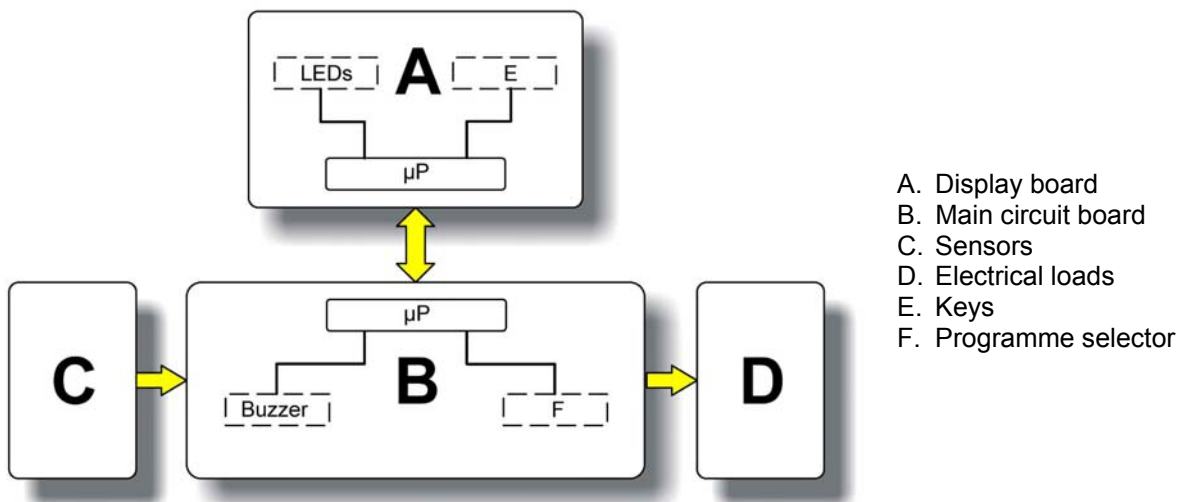

- The main circuit board receives signals concerning the setting of the drying cycle from the control/display board.
- The main circuit board powers all the principal components: motor, pump (for dryers with canister in the upper section), the heating unit and the door interlock.
- The main circuit board controls the status of the door lock, the temperature of the air inside the dryer (detected by an NTC sensor), the level of humidity of the fabrics (measured by the conductimetric sensor) and the level of water in the canister.
- The buzzer is built into the main circuit board.

6.1.2 Electronic control system memory: general structure

The main circuit board is fitted with an EEPROM memory (external to the microprocessor) which stores configuration data, the description of the cycle, the status of the dryer in the event of a power failure, and any alarms.

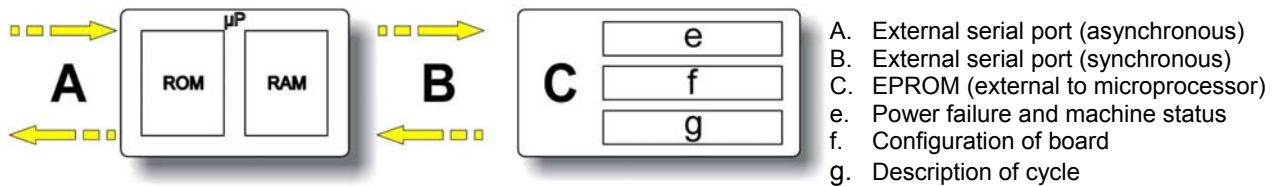

ROM

This area of memory contains the "firmware" code, which includes the functions provided by the appliance.

- Control of electrical loads (motor, pump, heating unit)
- Control of sensors (NTC, conductimetric sensor, door lock status)
- Control of user interface
- Control of serial port
- Control of power failures and alarms
- Execution of drying programme

In standard-production appliances, this area is a **Read Only Memory**, which cannot be modified.

RAM

This memory contains the variables, i.e. all the modifiable information used during the execution of the programme:

- Machine status
- Cycle selected
- Alarms

The RAM is deleted each time the appliance is disconnected from the power supply (in the event of a power failure or if the dryer is switched off).

The contents of the RAM can be accessed using a computer connected via a DAAS interface.

EEPROM

The EEPROM contains data of different types:

- **Power failure and machine status:** this information is necessary to re-start the machine in the event of a power failure.
- **Configuration of drying cycle (CCF):** this file describes the various steps in the drying cycles for each family of appliances.
- **Machine configuration (MCF):** the data contained in this area of memory define the configuration of the individual appliance.

These files define the following:

- Programmes
- Number and functions of keys
- Functions of the LEDs
- Operation of the buzzer
- Operating limits (voltage frequency)
- Identification of machine (PNC + ELC + serial number)
- Power of heating unit
- Preferential direction of rotation of the motor

6.2 Conductimetric sensor

The electronic control system utilizes a conductimetric sensor, which consists of an electronic circuit (internal to the main circuit board) and a section external to the board comprising wiring and two brushes for contact with the lifters and the drum.

The resistance is measured between the drum (1) and the lifters (2).

The resistance is determined by the quantity of washing, the type of fabric and the level of humidity of the wash load in the drum.

The brush (3) is in contact with the drum lifters through contacts (5) fitted to the contact band (4) which, in turn, is insulated from the drum by an insulating layer. The carbon brush (6) in contact with the drum spindle is inserted into the drum spindle cover (7). Connection of this sensor to the electronic circuit takes place across the cabinet, which represents the mass of the dryer's electrical circuit.

When the drum is empty, the resistance between the drum band and the sensor fitted to the lifters (which are insulated from the drum) is infinite. The resistance again become measurable as soon as damp washing is introduced into the drum, and is between 1MΩ and 25MΩ approximately. This value is transformed into an oscillation of about 260Hz to 0Hz which, when read by the electronic circuit (fuzzy logic) determines the duration of the selected cycle and the final level of humidity.

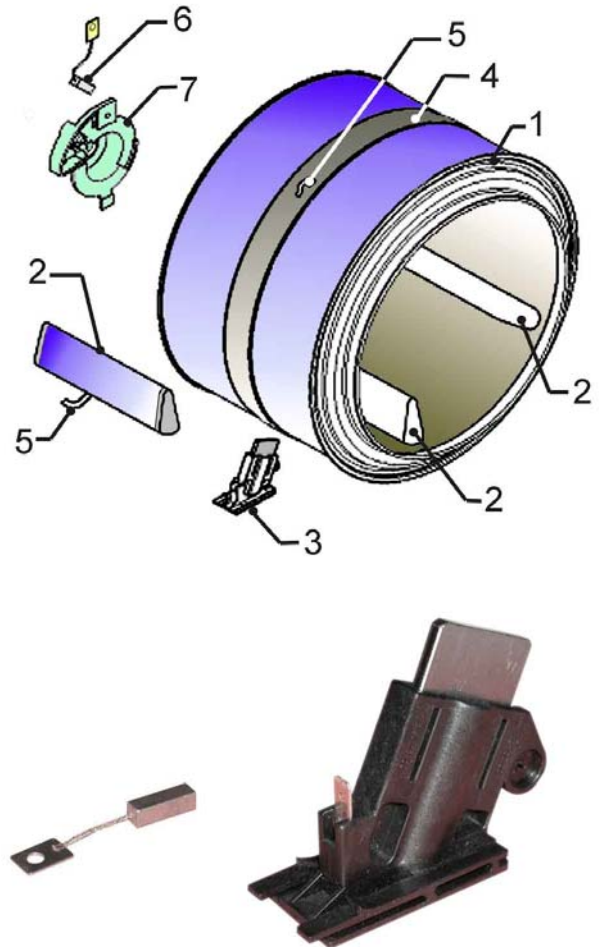

6.3 Terminal block with suppressor

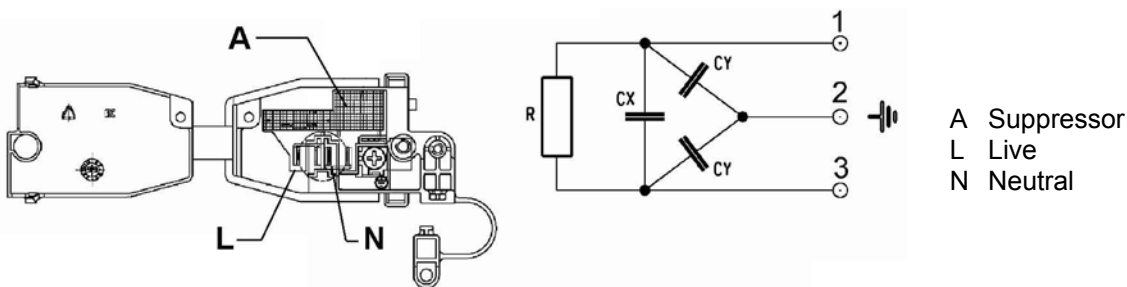

The suppressor is fitted inside the terminal block, and serves to ensure that radio disturbance generated by the dryer does not enter the main electrical circuit.

The suppressor functions correctly only if the appliance is correctly earthed.

Checking for efficiency:

Using a tester, measure the resistance across the following terminals:

- 1 – 2 = ∞
- 2 – 3 = ∞
- 1 – 3 = ~ 2MΩ

6.4 Compressor

The compressor serves to circulate the liquid coolant (R134a).

Absorbed power 550 W

Resistance of primary winding 3.6 Ohm

Resistance of secondary winding 7.0 Ohm

Total weight 14 kg

Oil load: 320 cm³ ISO VG 22 ESTER

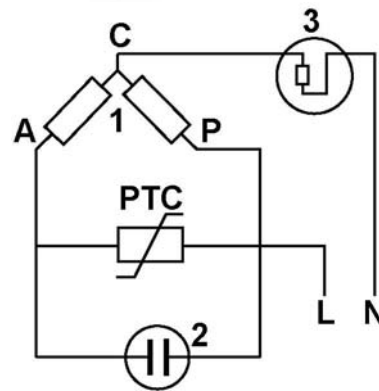

1. Compressor
2. Run capacitor
3. Motor overload cut-out

6.5 PTC motor protector

The PTC motor protector consists of a PTC (positive temperature coefficient) (2) necessary to determine the direction of rotation during the start-up phase (see figure), and a protective casing comprising a bi-metal element (3) which trips when the motor absorbs too much current due to overloading.

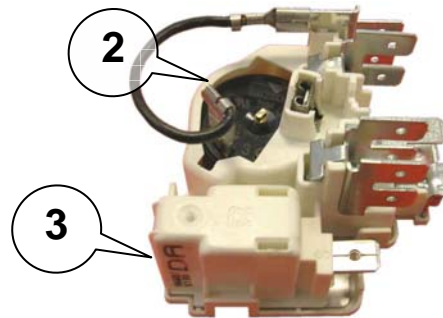

6.6 Motor compressor capacitor

The function of the capacitor is to improve the performance of the compressor motor.

16 μ F 400V



6.7 Fan cooling compressor

Axial fan mounted on ball bearings.

Power absorption 23 W

2600 / 3000 rpm



6.8 Drum motor

The drum motor assembly consists of a belt tensioner and a 110W single-phase asynchronous motor fitted with an overload cut-out.

The power to the motor is provided by the main circuit board via a relay (which determines the direction of rotation) and a TRIAC.

The efficiency of the motor can be checked by measuring the resistance across the windings:

Winding **A** ohm 29 ~ (contacts 1-3)

Winding **B** ohm 29 ~ (contacts 2-3)

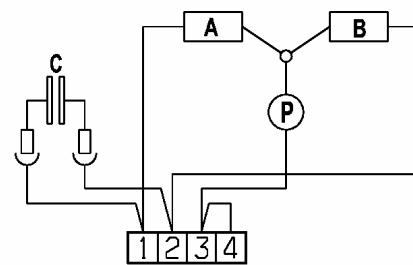

6.9 Drum motor capacitor

The run capacitor for the motor which drives the drum is connected to contacts (1) and (2). Its capacity is 9 μ F.



6.10 Canister fill pump

This pump is actuated by a synchronous motor with a power of about 17W.

Its function is to pump the condensation water to the canister. The pump is powered via a TRIAC.

Resistance measured across the ends of the coil: 750Ω approx.



6.11 Air circulation fan

The fan, which ducts the warm, dry air into the drum, is actuated by a motor/fan unit fitted directly inside the rear air duct.



Power absorption 150 W
2450 rpm

6.12 Fan motor capacitor

The run capacitor for the drum rotation motor is connected to contacts (1) and (2) of the terminal block, and has a capacity of 5μF.



6.13 NTC sensor

The NTC sensor is located at the outlet of the capacitor and comprises a resistor, fitted inside a metal capsule, whose resistance decreases as the temperature increases.

The electronic circuit reads the resistance and actions the compressor cooling fan so that the temperature of the liquid coolant at the capacitor outlet remains constant.

1. Terminals
2. NTC resistor
3. Capsule
4. Plastic housing

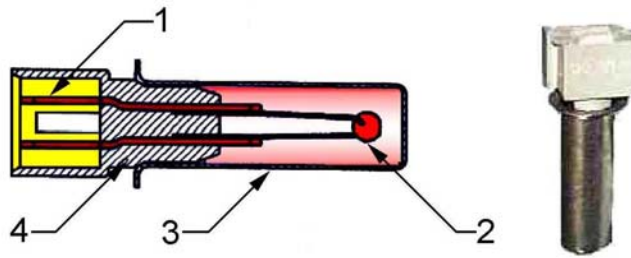

TEMPERATURE (°C)	RESISTANCE (Ω)		
	Nominal value	Maximum value	Minimum value
20	6050	6335	5765
60	1250	1278	1222
80	640	620	660

6.14 Door switch

The door switch powers the electrical components after the door has been closed and the selector has been turned (ON/OFF switch). The switch is located above the door latch and is closed, when the door is closed, by a pin fitted to the door.

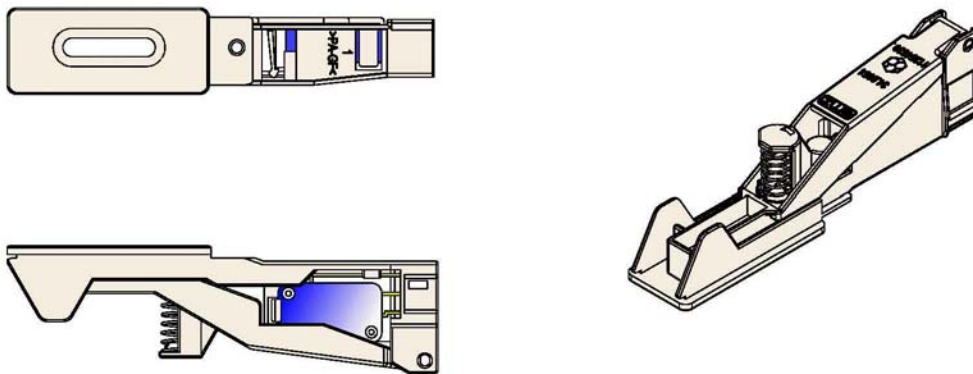

6.15 Door interlock

Depending on the model, the door interlock may be mechanical with manual door aperture or electronic with door aperture actioned by pressing a key. In the latter case, the door is opened by an electromagnetic coil which releases the latch by actioning a lever.

The door interlock also features a child safety device so that, if necessary, the door can be opened from the inside by simply pushing outwards.

1. Latch lever
2. Coil (on models with automatic aperture)
3. Coil protective casing

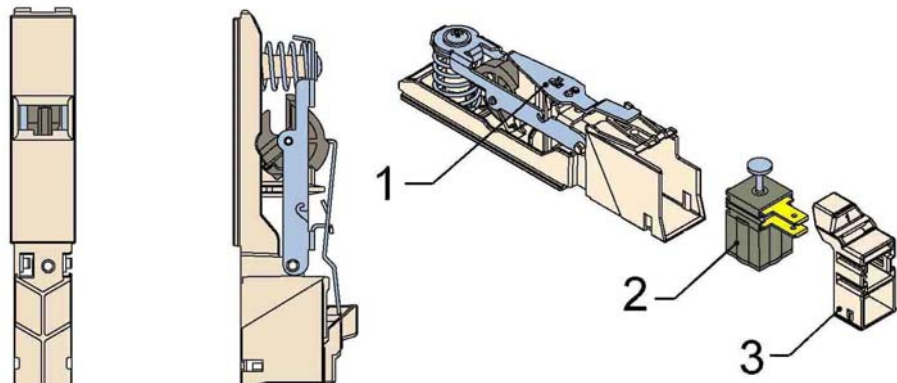

7 Circuit diagram

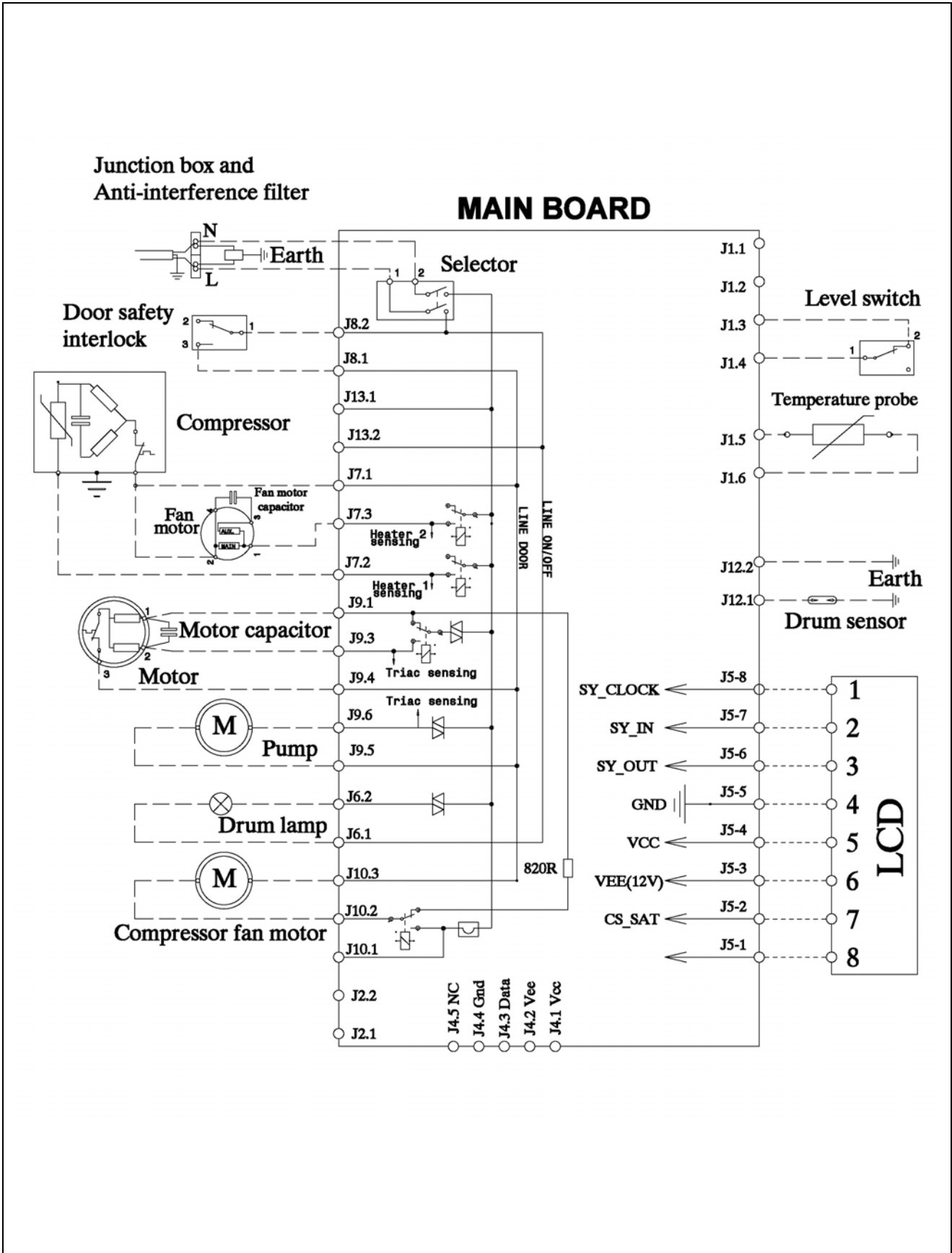

8 Diagnostics system

Diagnostics mode can be used to check the operation of the appliance and read any alarms.

8.1 Access to diagnostics

1. The appliance must be switched OFF.
2. Switch on the appliance by turning the programme selector **one position in a clockwise direction**.
3. Wait until the LEDs light and the buzzer sounds a "bip", then press the key combinations according to the model

Important: This operation must be carried out within 5 seconds!

4. Hold the keys down until the LEDs begin to flash and the buzzer sounds.

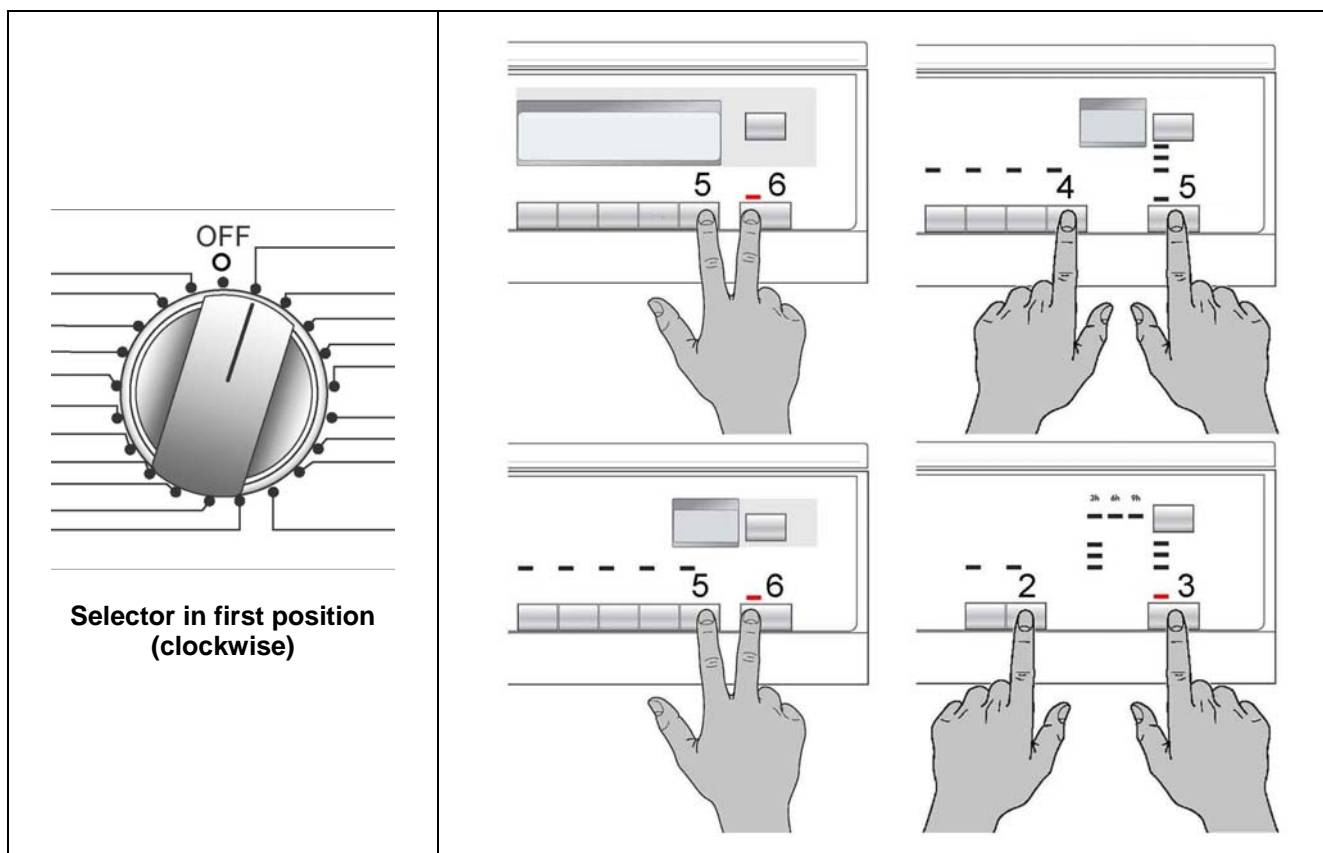

IMPORTANT!

- The alarms remain enabled during diagnostics tests on the components. If an alarm condition is displayed, move the programme selector to the first position in order to exit the alarm condition and continue with the test (if the alarm is not repeated).
- To check for correct operation of the float switch and the pump, the sump should be filled with about 0.7 litres of water.
- For correct control of the conductimetric sensor when short-circuited (position 8), first remove the cover and short-circuit either the two half-shells of the drum or the front drum shell and earth. After commencing this phase, the short circuit must be created within just **one second**, so it is necessary **to prepare to short the circuit** before moving the programme selector to the eighth position (it is advisable to do this in a position in which the drum is not in movement and then to pass rapidly to this position). If the short-circuit is not created correctly, the circuit board displays alarm E32 (sensor frequency too low). To exit the alarm condition, move the programme selector to the first position.
- Open the access panel to the condenser to check for correct operation of the switch: the buzzer sounds four "bips", each with different tones, repeating this sequence every 7 seconds.

8.2 Exiting the diagnostics system

To exit the diagnostics system turn the programme selector to position **zero**, switch the appliance on again in order to effect a general reset of the electrical parts, then switch off again.

8.3 Selector positions for diagnostics (conductimetric appliances)

 ATTENZIONE	<p>Models with LCD: When the service engineer accesses the various functions in diagnostics mode, a code is shown in the bottom right-hand corner of the display (e.g. C5 - C5 etc.). These are simply codes relative to the programme selector, and have no effect on the tests to be performed.</p>
--	--

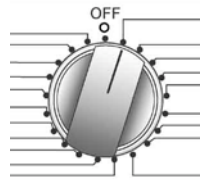
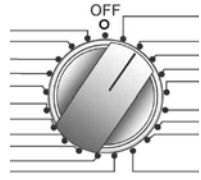
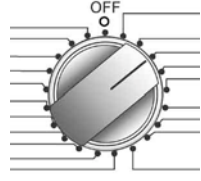
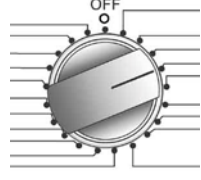
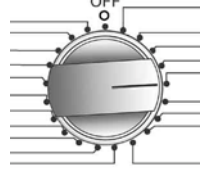
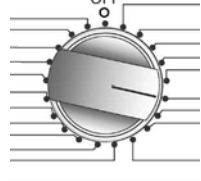
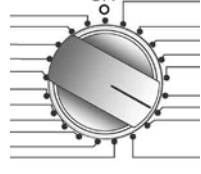
Position of selector	Components actioned	Operating condition	Function checked
1 	<ul style="list-style-type: none"> ➤ All the LEDs and Digits light in sequence. ➤ When a key is pressed, the corresponding number is displayed. 	Always enabled	Operation of user interface
2 	<ul style="list-style-type: none"> ➤ Level sensor in condensation canister ➤ Canister fill pump ➤ Compressor cooling fan 	Door closed Sump contains 0.7 litres approx.	Operation of floating microswitch and canister fill pump
3 	<ul style="list-style-type: none"> ➤ Counter-clockwise drum rotation ➤ Canister fill pump always powered ➤ Compressor cooling fan 	Door closed Max. time 10 min.	Control of motor TRIAC for counter-clockwise drum rotation
4 	<ul style="list-style-type: none"> ➤ Motor TRIAC powered in stepping mode ➤ Compressor cooling fan 	Door closed Max. time 10 min.	Control of clockwise drum rotation (at low speed for visual control of drum shell coupling)
5 	<ul style="list-style-type: none"> ➤ Clockwise drum rotation ➤ Circulation fan motor TRIAC ➤ Compressor cooling fan. 	Door closed Max. time 10 min.	Control of correct direction of drum rotation and fan motor
6 	<ul style="list-style-type: none"> ➤ Clockwise drum rotation ➤ Circulation fan motor TRIAC ➤ Compressor command ➤ Compressor cooling fan. 	Door closed (*)	Control of heating unit The display shows the temperature read by the NTC
7 	<ul style="list-style-type: none"> ➤ Conductimetric sensor with the drum short-circuited. Duration of check 4 sec (1 sec. to create short circuit) during which the LED flashes. ➤ If at the end of the test the result is correct, the LED switches off; otherwise the LED flashes and alarm E32 is displayed. 	Door closed Short-circuit between two drum shells.	Control of conductimetric sensor in short-circuit condition

(*) On completion of this test, the compressor re-starts only after a pause of 5 minutes.

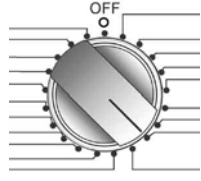
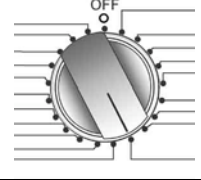
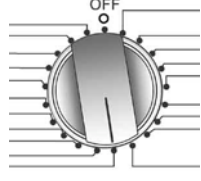
Position of selector	Components actioned	Operating condition	Function checked
8 	<ul style="list-style-type: none"> ➤ Conductimetric sensor. Duration of check 4 sec. during which the LED flashes. If at the end of the test the result is correct, the LED switches off; otherwise the LED flashes continuously. 	<p style="text-align: center;">Door closed</p>	<p style="text-align: center;">Control of conductimetric sensor with the circuit open</p>
9 	<ul style="list-style-type: none"> ➤ Float switch ➤ Canister fill pump: with switch closed 	<p style="text-align: center;">Door closed Max. time 30 sec.</p>	<p style="text-align: center;">Operation of float switch (with sump empty)</p>
10 	<ul style="list-style-type: none"> ➤ Reading/Cancelling of the last alarm. ➤ Turn the knob to position 10, taking care not to pause on position 7, otherwise error E32 might occur 		

9 Alarms

9.1 Displaying the last alarm to the user

Control of the alarms is configurable. Therefore, depending on the model, some or all alarms can be displayed to the user.

Normally, all alarms except E61, E97 and EB2 are displayed to the user.

When an alarm condition occurs, the drying cycle may be stopped or paused. In certain cases, for reasons of safety, a forced cooling cycle is performed and the motor switches on to cool the drum using the fan. The cycle remains selected until the user switches off the appliance.

9.2 Displaying alarms during normal operation

In models with LCD, the family to which the alarm belongs is displayed.

For example, alarm E53 (malfunction of motor TRIAC) is displayed as follows:

- First digit: "E" (error)
- Second and third digits: "5 0", i.e. the family to which alarm E53 belongs)

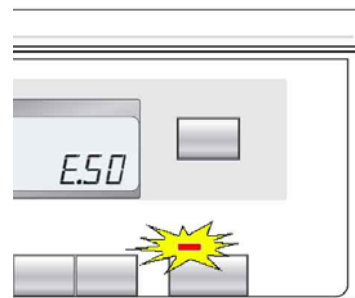

In all models, the same number is displayed in the form of a repeated sequence of flashing of the START LED (cycling sequence: 0.4 seconds ON, 0.4 seconds OFF, with a pause of 2.5 seconds between each ON/OFF sequence). In the case of alarm E53, the series of five flashes indicates the first of the two numbers in alarm code E53 (the alarms relative to the same function are grouped into families).

9.3 Reading the alarms

Proceed as follows to read the last alarm condition memorized in the EEPROM on the circuit board:

- Access diagnostics mode (see relative paragraph)
- Turn the programme selector to position 10, taking care not to pause on any other position, otherwise error E32 might occur

9.3.1 Displaying the alarms: models with LCD

- First digit "E"
- Second digit: alarm family
- Third digit: alarm number

9.3.2 Displaying the alarms: models without LCD

The alarm is displayed in the form of a repeated sequence of flashing of the START LED (cycling sequence: 0.4 seconds ON, 0.4 seconds OFF, with a pause of 2.5 seconds between each ON/OFF sequence).

9.3.3 Displaying other alarms

Press the START key to display all the other alarm conditions detected by the appliance. The alarms are displayed in sequence.

9.3.4 Cancelling the last alarm

It is good practise to cancel all the alarm conditions stored in memory:

- after reading the alarm, in order to check whether it re-occurs during the diagnostics routine.
- after effecting repairs, to check whether it re-occurs during testing.

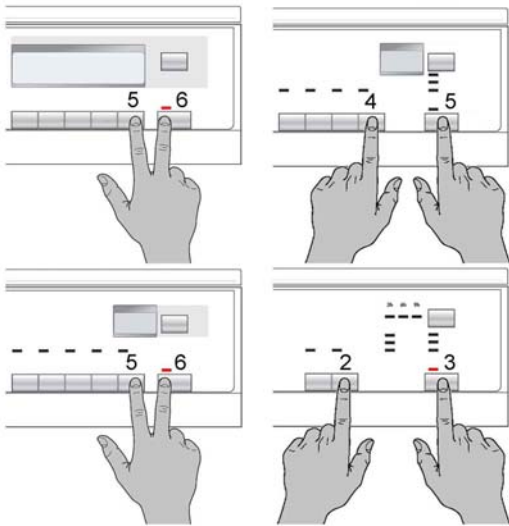
<ol style="list-style-type: none">1. Access diagnostics mode (see relative paragraph).2. Turn the programme selector clockwise to the tenth position.3. Press START/PAUSE and the key immediately to the left of the START/PAUSE key simultaneously.4. Hold both keys down for about 5 seconds.5. When the alarms have been cancelled, the display will show E00.	
--	---

9.3.5 Notes concerning alarm conditions E93, EH1, EH2 and EH3

- **Configuration alarm - E93:** If this alarm is detected (when the appliance is switched on), operation is interrupted and all the LEDs light. It is not possible to access diagnostics mode. The only operation that can be performed is to switch off the appliance (programme selector on position "0").
- **Alarms EH1-EH2-EH3:** In the event of power supply problems, the appliance remains in alarm mode until the mains voltage and frequency are restored to the correct levels, or until the dryer is switched off (programme selector on position "0"). The alarm family "H" is displayed and it is not possible to access diagnostics mode nor to use the "rapid alarm display" option. The complete alarm code can be read only when the abnormal condition has been eliminated.

9.4 Table of alarms

Alarm	Description	Possible fault	Remedy / Machine status	Reset command
E00	No alarm	---	---	---
E21	Canister fill pump TRIAC faulty	Faulty wiring; Main circuit board faulty	Cycle stopped	OFF
E22	"Sensing" circuit of canister fill pump TRIAC faulty	Main circuit board faulty	Cycle stopped	OFF
E31	Frequency of signal from conductimetric sensor too high	Main circuit board faulty	Alarm enabled only in diagnostics mode	---
E32	Frequency of signal from conductimetric sensor too low	Faulty wiring; Brushes worn/faulty; Main circuit board faulty.	Cycle stopped	OFF
E33	Appears when displaying the last alarm. If position 8, NOT OK.	Faulty wiring; Brushes worn/faulty; Main circuit board faulty.	Alarm enabled only in diagnostics mode	---
E45	Door closure sensor	Door lock faulty; Faulty wiring; Main circuit board faulty	Cycle stopped	OFF
E51	Motor power TRIAC short-circuited	Motor faulty; Faulty wiring; Main circuit board faulty	Cycle stopped	OFF
E52	Motor overload cut-out tripped	Motor faulty; Motor overload cut-out tripped; Faulty wiring; Main circuit board faulty	Disconnects the power supply to the heating unit and interrupts reversal of rotation. If the problem disappears, the alarm is stored in memory and the cycle resumes. If the fault persists after several attempts to restore the power supply (about 35 minutes), alarm E51 is generated.	OFF
E53	"Sensing" circuit of motor TRIAC faulty	Main circuit board faulty	Cycle stopped	OFF
E54	Motor stopped	Excessive wash load; voltage too low; motor/transmission system jammed	Cycle paused after a number of attempts by the motor to re-start	START

E61	Insufficient heating (maximum time exceeded)	Heating unit faulty; Faulty wiring; NTC sensor incorrectly calibrated/seated; Main circuit board faulty	Cycle paused	Start
E62	Power relay for heating unit faulty	Heating unit faulty; Faulty wiring; Main circuit board faulty	Forced cooling cycle	OFF
E63	Auto-reset thermostat on heating unit tripped	Thermostat faulty (replace heating group); Heating group faulty; Faulty wiring; Main circuit board faulty	Disconnect the heating unit from the power supply. If the problem disappears, the alarm is stored in memory and the cycle resumes. If the fault persists after several attempts to restore the power supply, alarm E62 is generated.	OFF
E64	Heating element thermostat	Heating element thermostat faulty; Faulty wiring; Main circuit board faulty		
E65	Fan motor TRIAC faulty	Fan motor wiring disconnected; motor faulty; TRIAC interrupted		
E66	Fan motor overload cut-out	Fan motor wiring disconnected; motor faulty; TRIAC interrupted		
E67	TRIAC control faulty	Fan motor wiring; crm board faulty		
E71	NTC sensor1 faulty	NTC sensor1 faulty; Faulty wiring; Main circuit board faulty	Forced cooling cycle	OFF
E72	NTC sensor2 faulty	NTC sensor2 faulty; Faulty wiring; Main circuit board faulty		OFF
E82	Selector faulty in OFF position	Board wiring; board faulty		
E83	Selector positions incorrect	Board wiring; board faulty		
E93	Dryer configuration incorrect	Incorrect EEPROM configuration. Main circuit board faulty	Cycle stopped	OFF
E94	Drying cycle configuration incorrect	Incorrect EEPROM configuration Main circuit board faulty	Cycle stopped	OFF
E97	Incongruency between programme selector and cycles	Configuration error	Cycle stopped	OFF
EA1	CRM board communication faulty	Board wiring; CRM board faulty		
EA2	CRM board protocol incongruent	Incorrect software; CRM board faulty		
EA3	Board selector faulty	Main circuit board faulty		
EA4	Incorrect selector protocol	Main circuit board faulty		

EH1	Power frequency not within limits	Power supply problem (incorrect/interference); Main circuit board faulty.	Cycle stopped; if the correct power supply is restored before the time-out has elapsed, the cycle resumes	OFF
EH2	Voltage too high	Power supply problem (incorrect/interference); Main circuit board faulty.	Cycle stopped	OFF
EH3	Voltage too low	Power supply problem (incorrect/interference); Main circuit board faulty.	Cycle stopped; if the correct power supply is restored before the time-out has elapsed, the cycle resumes	OFF
EC1	Voltage incongruent between boards	Power supply problem (incorrect/interference); CRM board faulty		
EC2	Frequency incongruent between boards	Power supply problem (incorrect/interference); CRM board faulty.		
EC3	CRM resistor over time limit (only in diagnostics mode)	CRM unit disconnected or faulty		
EC4	Heat generator resistance relay (CRM)	CRM unit disconnected or faulty; relay on board faulty		
EC5	CRM thermostat faulty	CRM unit disconnected or faulty		
EC6	CRM piloting faulty	CRM board faulty		
EC7	CRM pump TRIAC	Pump wiring disconnected; pump faulty; TRIAC faulty		
EC8	CRM pump diode	Diode on wiring short-circuited		
EC9	CRM pump piloting faulty	CRM board faulty		
ECA	Water canister empty	Canister level sensor wiring; canister level sensor faulty; water tube obstructed.		

10 The diagnostics cycle does not start

10.1 None of the LEDs on the display board lights

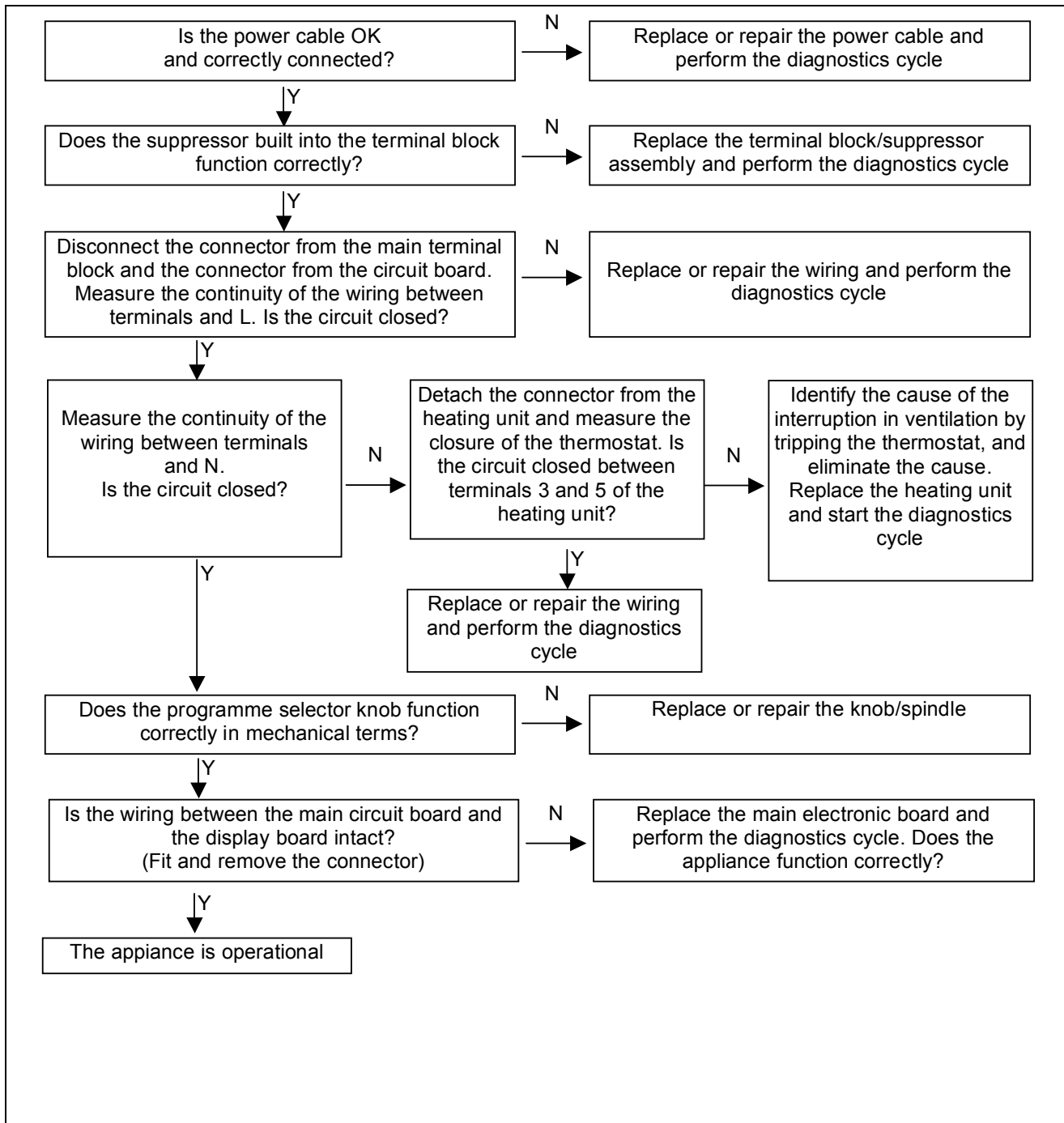

Some of the LEDs on the display board light

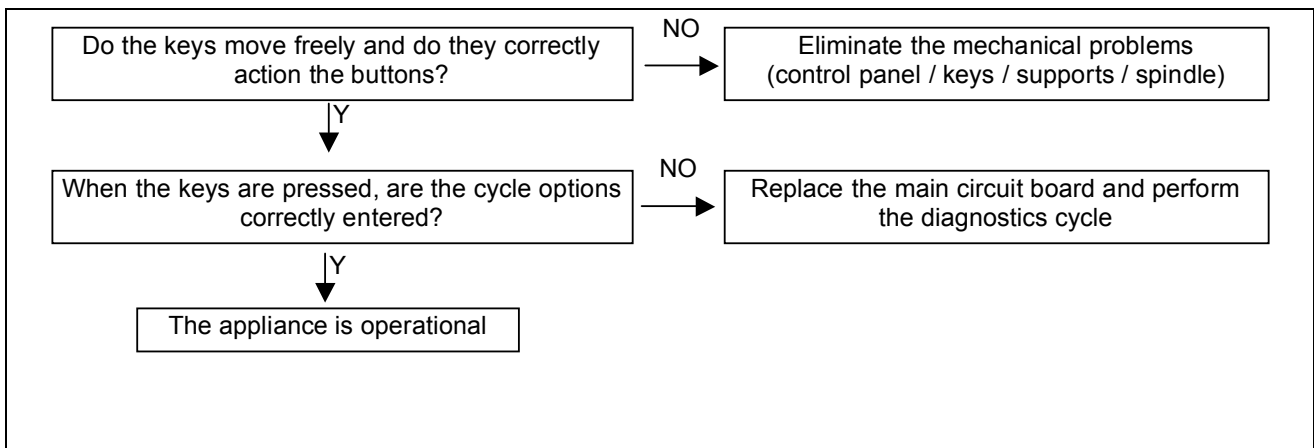

Important!

The diagnostics system cannot be accessed if the main circuit board has not been correctly configured. In the event of configuration errors (E93), all the LEDs flash.

11 Access to components

11.1 Door

To remove the door, remove the screws which secure it to the front panel



11.2 Fluff filter

11.2.1 Fluff filter on door

Press the tab on the filter support and push upwards to remove. The filter should be cleaned after every cycle.

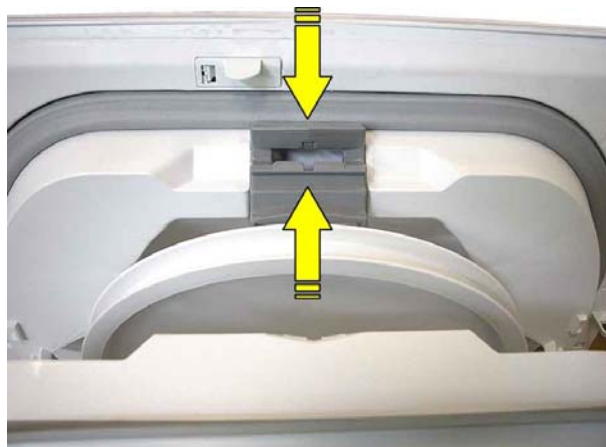

11.2.2 Lower fluff filter

Remove the filter from its seat by lifting it upwards. The filter should be cleaned at the end of each cycle.



11.2.3 Evaporator fluff filter

To open the compartment, press the tab and pull the evaporator fluff filter support outwards.

Press the two locking tabs at the sides of the filter support and lift the filter out.

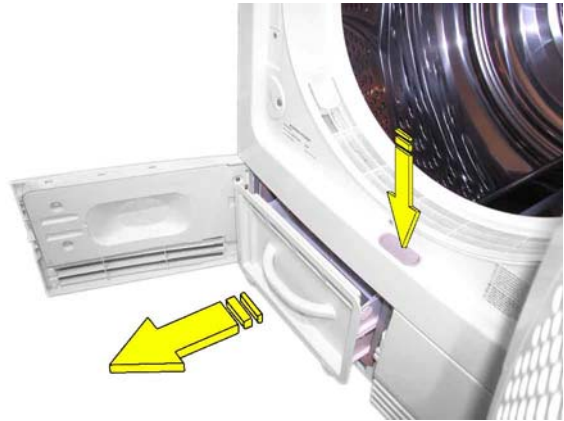
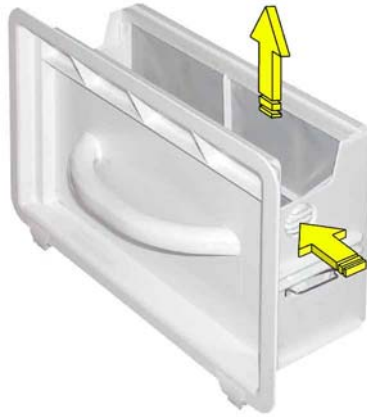

11.2.4 Fluff filter for water from evaporator

An additional filter, positioned beneath the fluff filter support, serves to prevent water containing microfluff particles from reaching the pump and blocking its operation.

To remove this filter, remove the two screws from the sides and pull outwards.

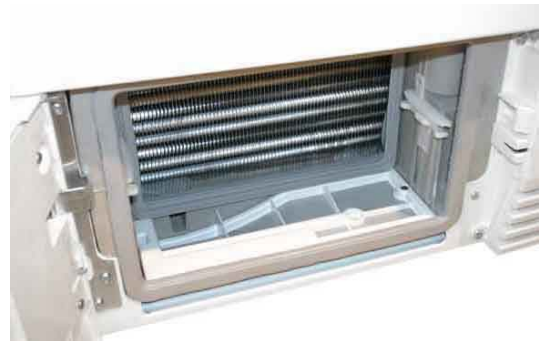

11.3 Compressor for fan motor

The compressor cooling motor is located in the front section, behind the right-hand section of the plinth.

Remove the two screws, move the cover slightly to the left and remove the plinth.

Move the two motor retaining clips upwards and tilt the motor slightly downwards.

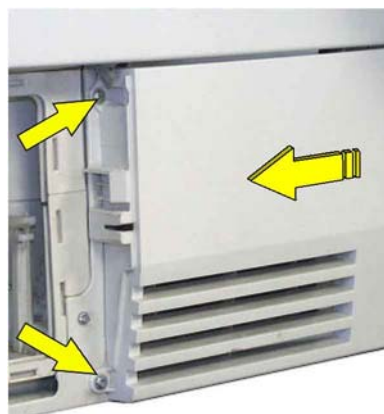

11.4 Door lock

Remove the two screws, push the lock slightly downwards and tilt forward to remove.

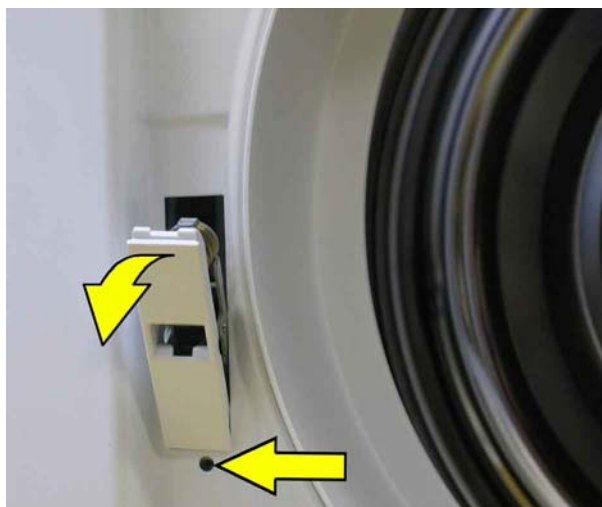

11.5 Door microswitch

Remove the screw, pull the microswitch slightly outwards and to the left until it reaches the connector.

Detach the connector and apply adhesive tape to hold it in position on the front panel so that it is not retracted inside the appliance.

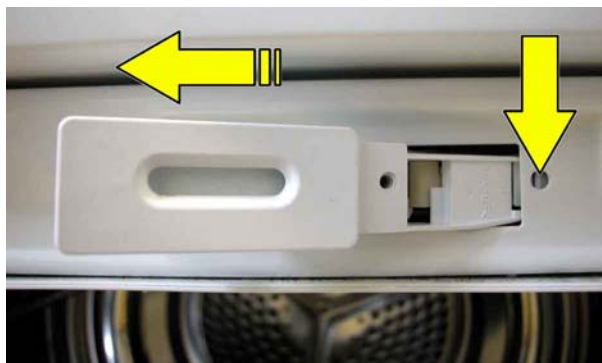

11.6 Door lock latch - Door microswitch latch

To remove the door lock latch and the microswitch latch, use a screwdriver to press the anchor tabs and turn in the direction indicated by the arrows.



11.7 Drum light bulb

The bulb can be replaced from inside the drum.

Unscrew the lamp cover and replace the bulb with one having the same characteristics.

When replacing the cover, ensure that the sealing ring is correctly inserted.



11.8 Canister

Pull the canister out completely, taking care to avoid spilling any residual water onto electrical components.



11.9 Work top

To remove the work top, first remove the two screws which secure it to the rear section of the dryer. Then push towards the rear of the appliance and remove.



11.10 Control panel/support assembly

Remove the canister and remove the screws which secure the control panel to the canister casing.



Remove the screws which secure the control panel cross-member and tilt forward the entire cross-member together with the control panel.



11.11 Main circuit board

11.11.1 Removing the board

After removing the entire control panel assembly, detach all the wiring (remember to note the positions of each connector to facilitate re-connection).

Remove the main circuit board by removing the 8 screws which secure it to the control panel.

Use a screwdriver to lever open the anchor tabs (do not use excessive pressure) and remove the board.

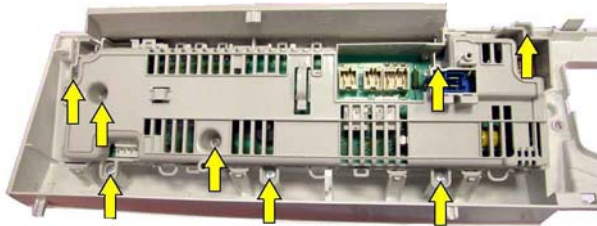

11.11.2 Removing the selector knob spindle

After removing the main circuit board, the selector knob spindle can be detached.

Turn the spindle to the **OFF** position and pull outwards.

IMPORTANT

If the spindle proves difficult to remove, check that it is in the correct position.

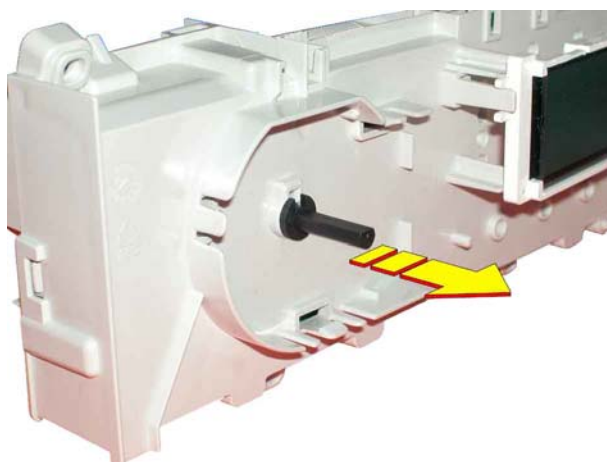

11.11.3 Removing the selector knob

After removing the main circuit board it is possible to remove the programme selector knob.

Press the two lateral tabs inwards and simultaneously push them outwards.

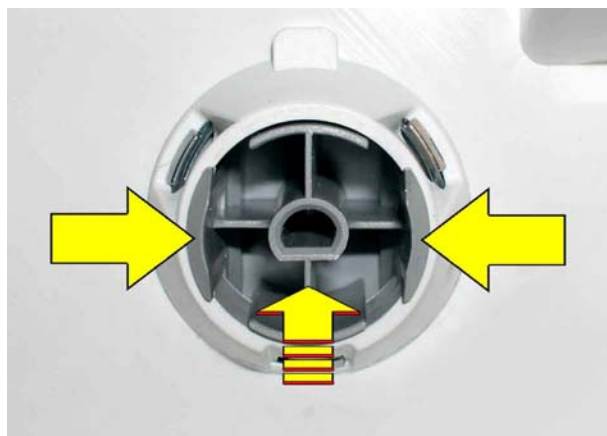

11.11.4 Key spring strip

The key spring strip is attached to the main circuit board support by lateral clips.

11.12 Side panels

First remove the screws which secure the side panels to the rear panel, then remove the screws which secure the side panels to the upper cross-members.

Lift the side panels slightly and remove.

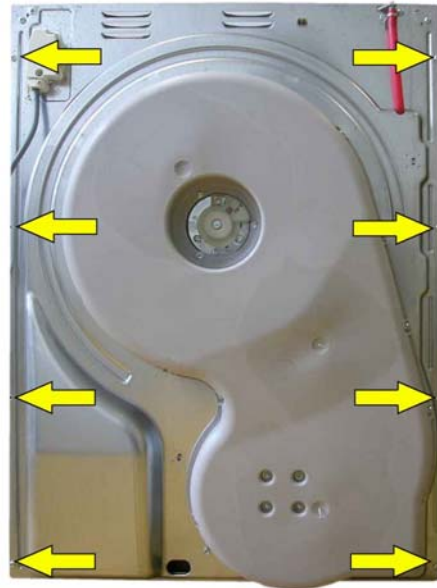

11.13 Water ducts

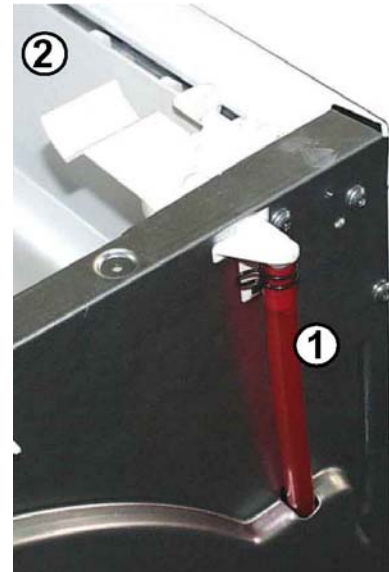
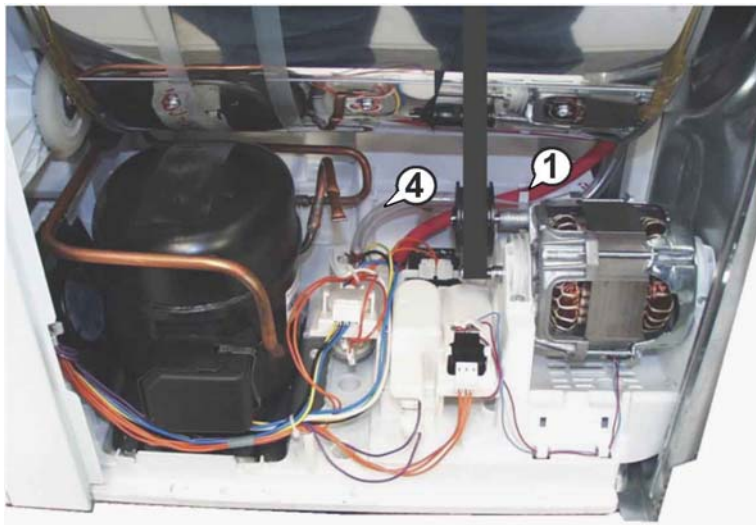

The water ducts are accessible from the right side of the appliance.

The condensation water is ducted into the canister (2) through a tube (1).

When the canister (2) is full, the water which overflows into the canister support (3) returns through a tube (4) into the sump.

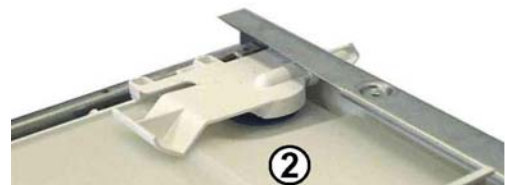
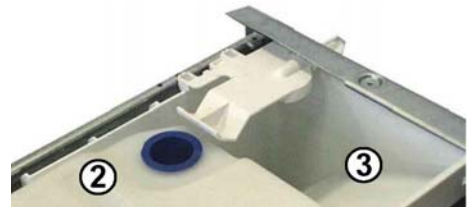

11.14 Condensation pump / float-actioned switch

The water which condenses during the drying cycle is collected in a tray (2) communicating with the float chamber (8).

The pump (3) is fitted inside the cover (1), which is anchored to the base of the appliance using three screws (S).

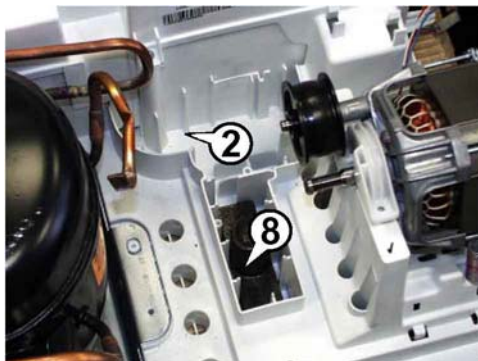
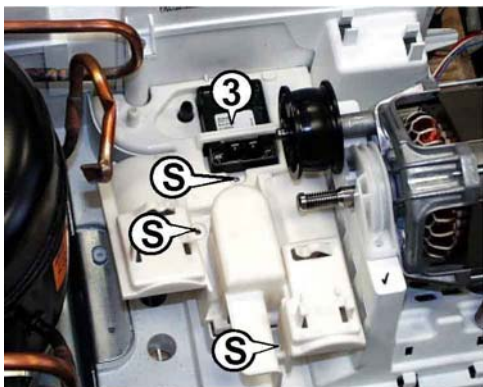

As well as the pump (3), the cover (1) also contains the run capacitor for the compressor motor (C) and the capacitor for the drum rotation motor, as well as the floating microswitch (5).

Pump

To remove the pump (3), remove the assembly (1), detach the wiring from the pump and use a screwdriver to release the pump, which is pressure-fitted.

Floating microswitch

The floating microswitch is fitted beneath the cover by screws.

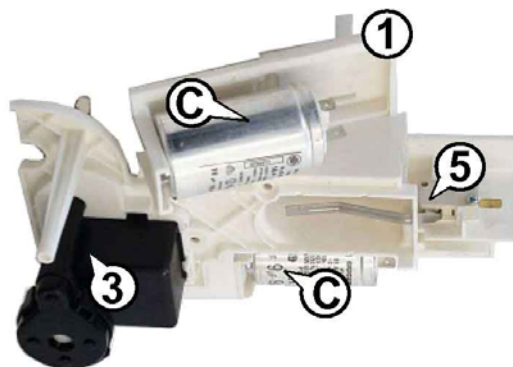
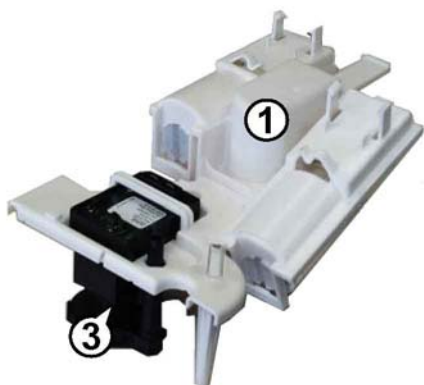

When replacing the cover, care must be taken to ensure that the float moves freely.

11.15 Drum rotation motor

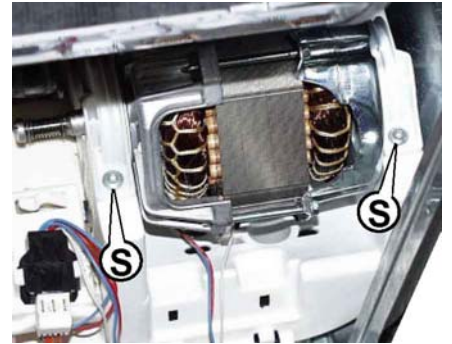
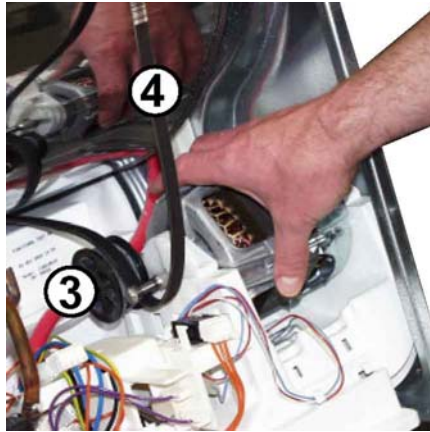
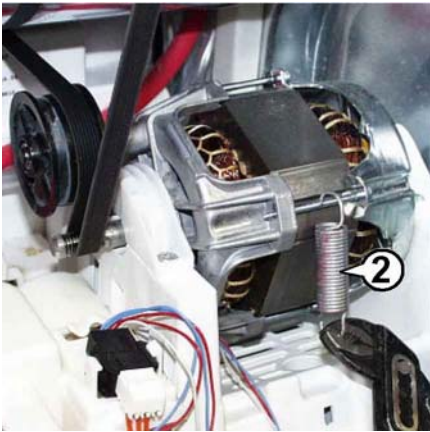

Detach the belt tensioner spring (2). This loosens the belt tensioner pulley (3), which is attached to the motor.

Turn the motor towards the interior of the dryer. This loosens the drive belt (4) which can now be removed.

Loosen the screws (S) which secure the front and rear motor brackets (5), rotate 90° and remove the brackets.

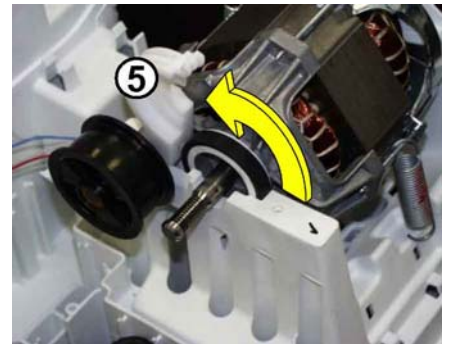

IMPORTANT

In some models, a plastic spacer is inserted between the rear bushing and the motor. Ensure that this spacer is correctly inserted when re-assembling.

11.16 NTC heat pump circuit



The NTC (1) is housed in a special pocket fitted to the side of the dehydration filter (3) in the heat pump circuit, between the condenser and the evaporator. The NTC is secured by a spring (2).

To remove the NTC, press the spring to release the lower extremity and remove the NTC.



11.17 Drum brush

The carbon drum brush (1) is located above the base of the appliance in a special housing.

To remove the brush, detach the electrical connector, lower the two clips (2) and pull the brush outwards.

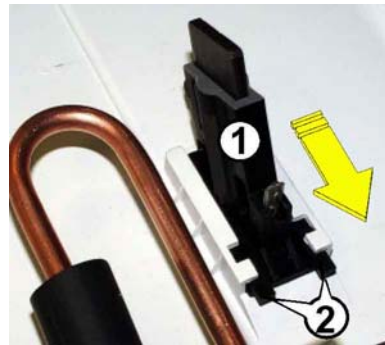

11.18 Rear brush

Remove the screws which secure the drum spindle cover.

Turn the cover until the lower anchor clip is released.

The brush is housed inside the drum spindle cover.



11.19 Rear air duct

Detach the connector from the fan (2).

Remove the 18 screws which secure the air duct to the rear panel. Do NOT remove the four screws (1) which secure the fan.

List the air duct slightly and remove from the rear panel.

After removing the air duct assembly, remove the four screws (1) and remove the fan (6). Separate the three components which form the air duct assembly.

External cover (3).

Insulating layer (4).

Internal air duct (5).

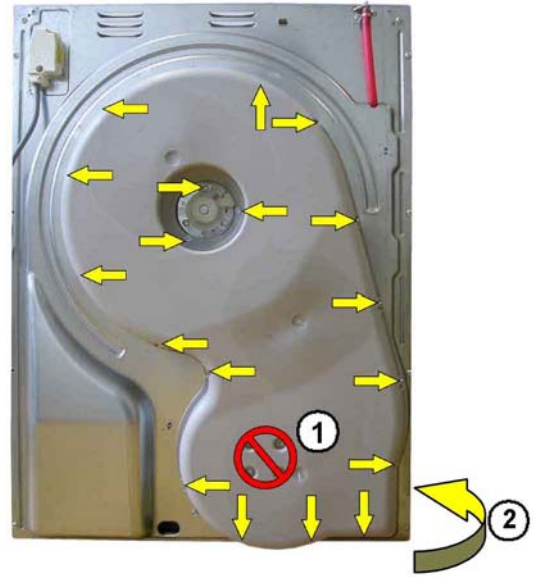

11.20 PTC and motor overload cut-out

To access the overload cut-out PTC, insert a screwdriver into the slot and move the cover to the right.

To remove the overload cut-out PTC, remove the screw (1) which secures it to the compressor, and remove the cable clamp (2).

Pull the entire overload cut-out PTC assembly outwards.

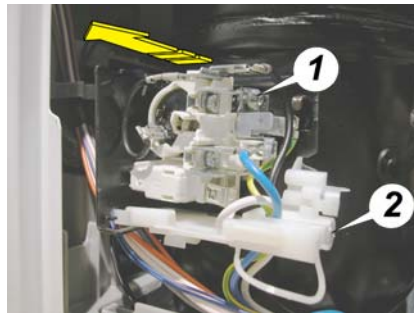
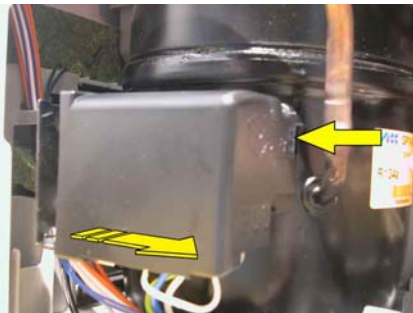

PTC overload cut-out

11.21 Dismantling the chassis for servicing



- Remove the side panels.
- Detach all the wiring.
- Remove the belt tensioner spring and loosen the drive belt.
- Remove the three screws (S) which secure the rear panel to the base.
- Remove the two screws (S) which secure the rear panel to the upper supports.
- Remove the red condensation tube.

After removing the rear panel together with the drum, the service engineer can easily access all the electrical components housed in the base of the appliance.



11.22 Air duct

Remove the drum.

Remove the screws which secure the hinges and the covers to the duct.

Detach the wiring as necessary.

Remove the duct

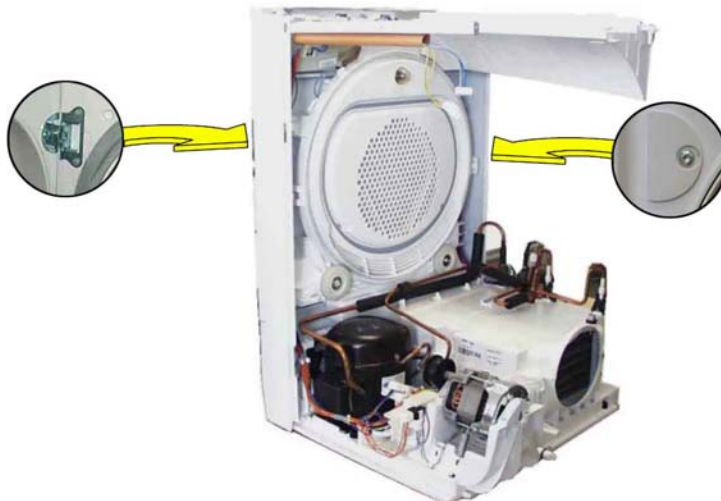

11.23 Front air seal

After removing the drum, the front air seal can be removed simply by pulling it out of its groove.

11.24 Idle pulleys

The idle pulleys can be removed after removing the drum.

Remove the screws which secure them in position and remove the pulleys.

IMPORTANT

*Do NOT attempt to remove the pulleys before removing the drum!
This might cause irreparable damage to the air duct.*



11.25 Rear air seal

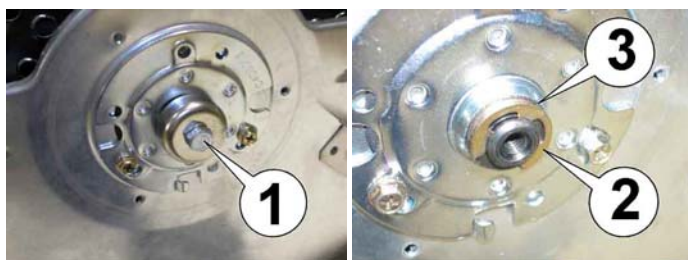

Remove the drum spindle cover.

Remove the screw (1) which secures the bushing.

Remove the elastic ring (2) and the spacing washer (3).

Detach the connectors from the main terminal block.

Detach the belt tensioner spring.

Remove the screws which secure the rear panel to the cross-members and the base, and remove the rear panel.

Remove the sealing strip from the groove.



12 Checking the efficiency of the heat pump

To check the efficiency of the heat pump, place the sensors in the positions indicated in the figure and compare the resulting graphs with those shown below.

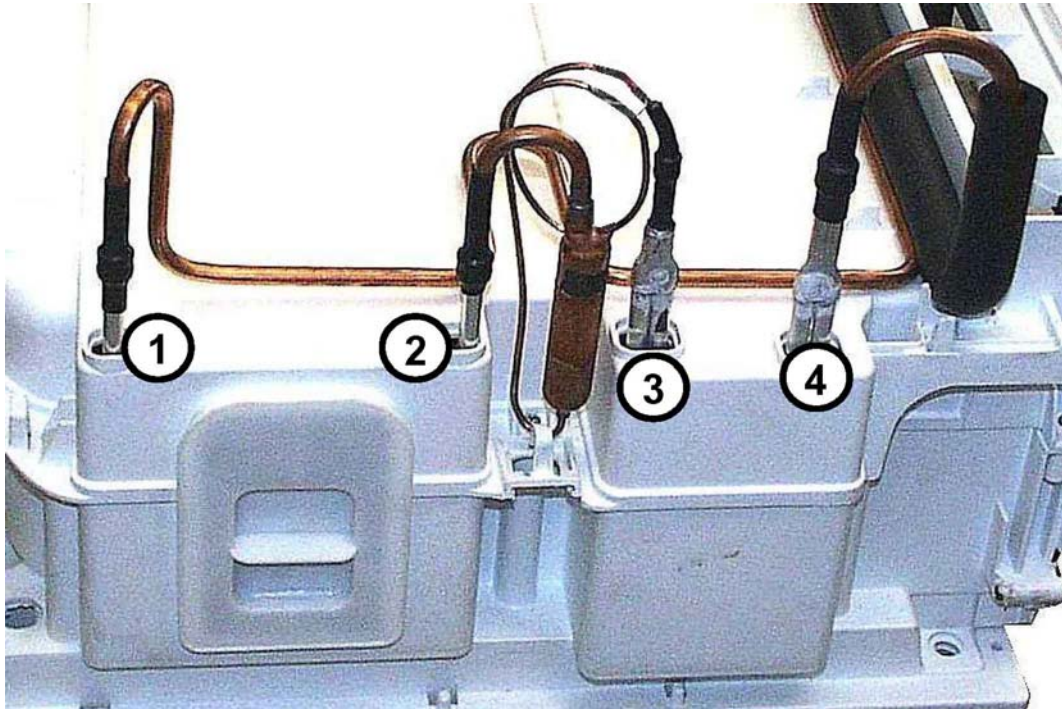

- 1 Condenser inlet
- 2 Condenser outlet

- 3 Evaporator inlet
- 4 Evaporator outlet

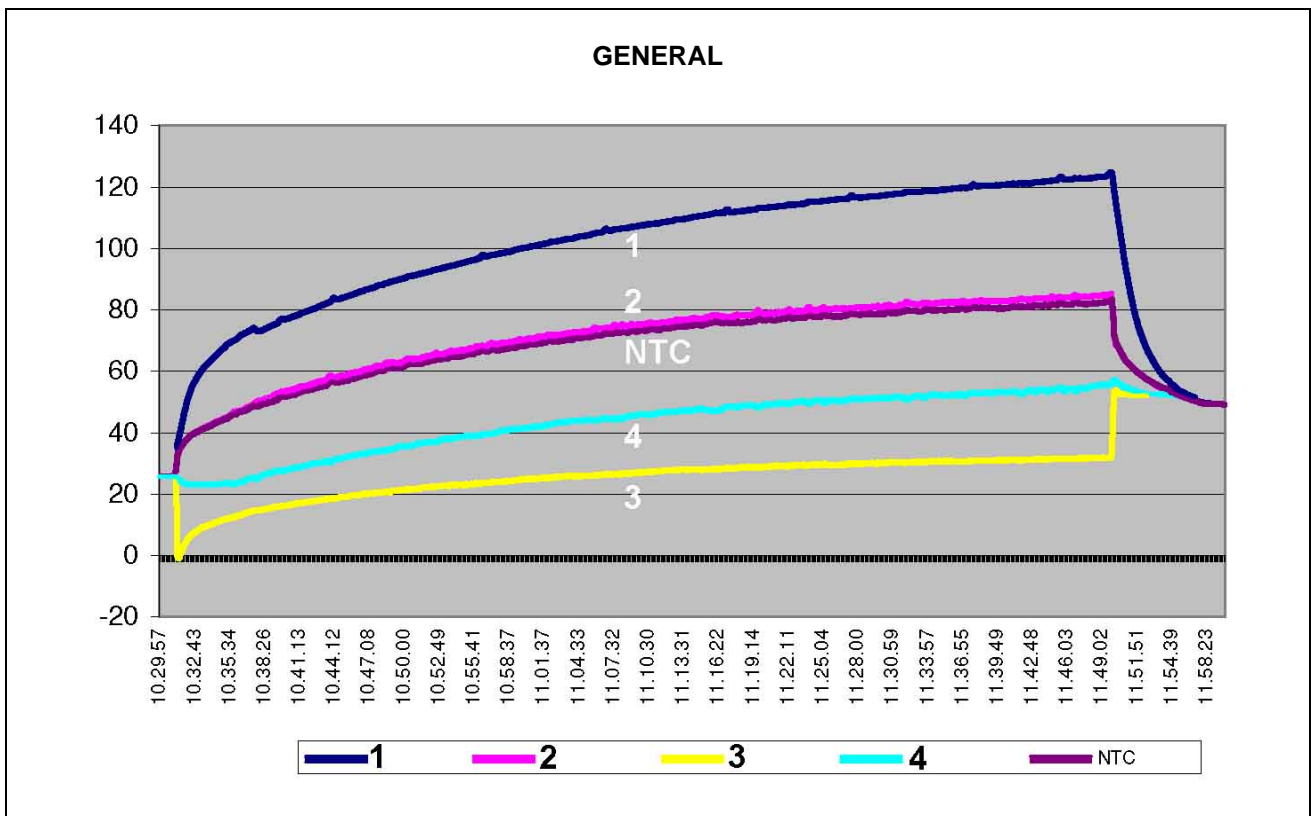

DELICATE FABRICS

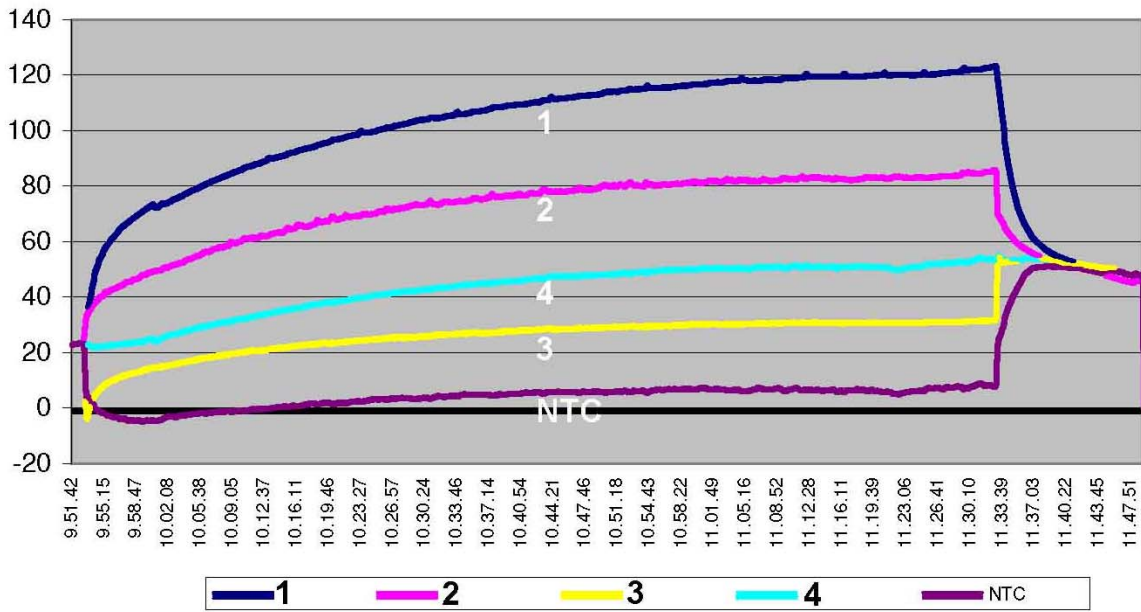

EXTRA

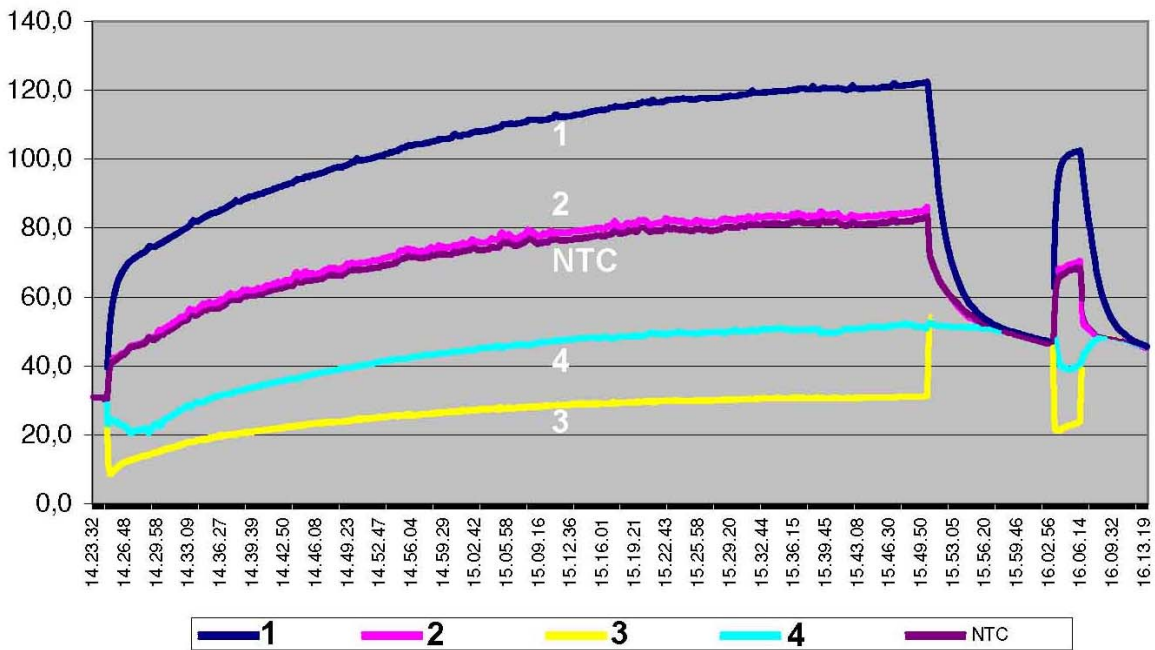

EXTRA 5 Kg - 3 litres WATER

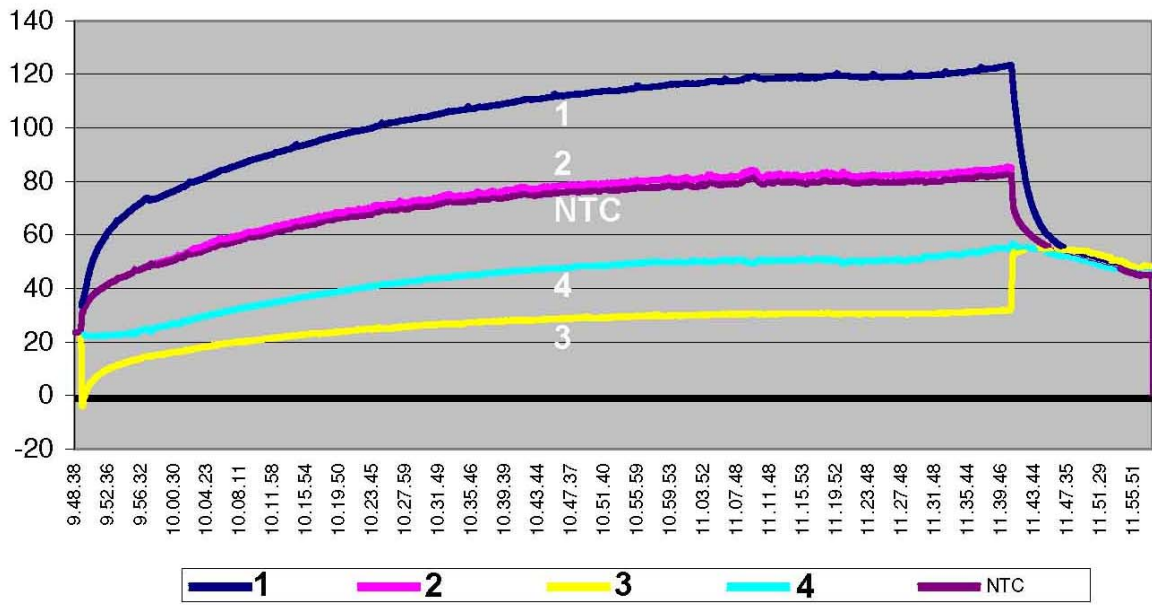

12.1 Servicing the heat pump circuit

12.1.1 Replacing the compressor

Disconnect the appliance from the power supply.

Use the special needle valve (1) to evacuate the gas.

Dispose of the R134a liquid coolant in the appropriate manner.

Loosen the compressor anchor elements to facilitate access.

Use a pipe-cutter to cut the intake pipe (2) and the delivery pipe (3).

The compressor can now be replaced.

Connect the intake and delivery pipes to the circuit using LOCKRING couplings.

A Schrader valve (4) may be fitted to the intake pipe for filling and draining the circuit of the heat pump.

Alternatively, it is possible to connect a separate filling coupling with a valve (6) to the existing fill pipe (5).



12.1.2 Evacuation

The duration of the evacuation cycle must be at least 15 minutes. Evacuation should be performed on the intake side only.

This operation removes most of the extraneous gas and humidity from the cooling circuit.

The evacuation of the circuit must take place with the compressor switched off. During evacuation the compressor should be shaken at least once in order to release as much extraneous gas as possible from within the oil.

12.1.3 Filling

The liquid coolant may be topped up directly from the canister using a special balance.

R134a liquid coolant is sold in disposable canisters.

When filling with coolant, the compressors must be switched off and the service engineer must wear the appropriate protective clothing.

R134a 270g

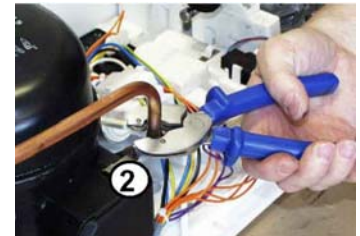

13 Door reversibility

Open the filter compartment door

Remove the filter compartment door by removing the two screws which secure the hinges (A) to the appliance.

Remove the masking plates (B) and (C) by levering off with a flat screwdriver.

Remove the door lock latch (D) by pressing with a screwdriver and fit it to the other side of the door (remember to turn it upside down).

Unscrew the hinges (A) from the door and replace them on the other side (rotate the hinges 180° before replacing).

Replace the masking plates (B) and (C) on the opposite sides (again, rotate 180°).

Unscrew the two masking plates (E) from the front panel, rotate them by 180°, and replace on the opposite side.

Remove the latch plate (F) by pushing it slightly upwards and then tilting forward.

Press the release tab on the masking plate (G) and, at the same time, push it downwards and tilt forward.

Move the latch plate (F) to the opposite side and use the screw removed previously to secure it in position.

Move the masking plate (G) to the opposite side and insert so that the tab enters the hole correctly.

Replace the door with the hinges now on the opposite side. Insert and tighten the screws and check for correct alignment and closing.

