

© AEG Hausgeräte GmbH
Muggenhofer Straße 135
D-90429 Nürnberg
Germany

Publ.-Nr.:
599 52 74 51
685
EN

Fax +49 911 323 1022

DGS-TDS-N
Edition 12.06

**Washing machines,
Toploader**

**Appliance
EWM 1100**

**ENV 06
TC6, TC5**

ELECTROLUX

CONTENTS

Control Panel.....	3	-	4
Push Buttons.....	5	-	8
Programselector / Programme	9	-	10
Buzzer / Extra rinse cycle / Child safety	11		
Functions of the System	12		
Connection electronic	13		
Electronic Module	14		
Door Lock.....	15		
DSP Function (Drum Self Position)	16		
Float switch / Inlet valve.....	17		
Water Inlet Valve for 3-chamber detergent box	18		
Water Distributor	19		
Analogic pressure switch	20		
Heating element	21		
Heating Circuit	22		
Drain pump / Motor	23		
Drum movements / Spin Profiles	24	-	26
Function of the FUCS	27	-	28
Foam Detection.....	29		
Service Program	30	-	38
Demo Program	39		
Electronic-Test.....	40		
Circuit Diagram	41	-	44
Program	45	-	51
Changes.....	52		

Control Panel

Version TC6 (Electrolux-design)

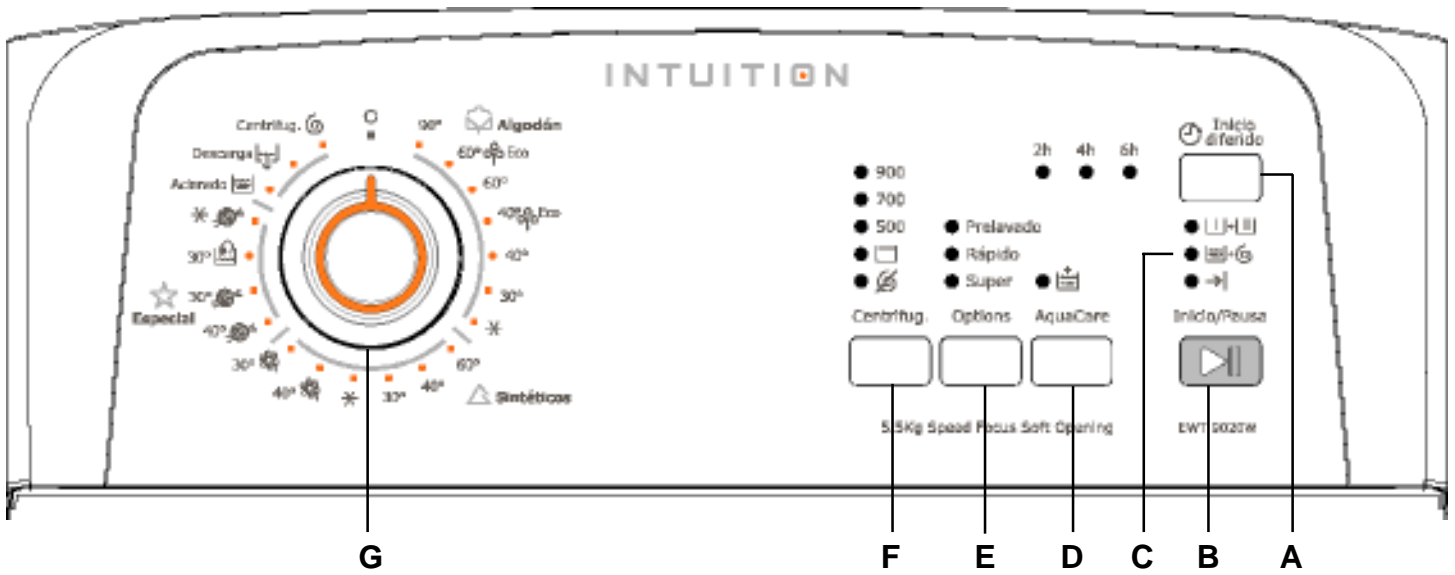

- A Delayed start
- B Start, Pause
- C Cycles
- D Extra rinses

- E Options
- F Spin
- G Programselector

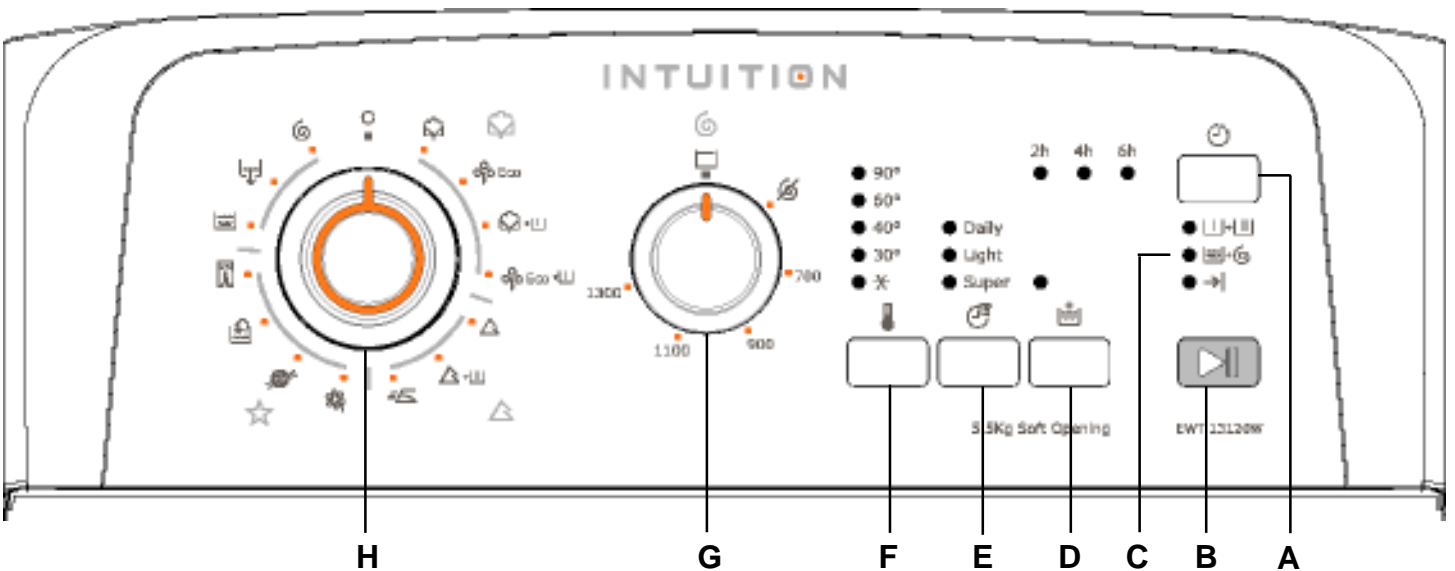

Version TC5 (Electrolux-design)



- A Delayed start
- B Start, Pause
- C Cycles
- D Extra rinses

- E Options
- F Temperature
- G Spin speed selector
- H Programselector

Cycles

LED-pretwash and mainwash	
LED-rinces and spin	
LED-end	

Standby

Function:

- After 10 minutes of standby in the pre-selection position or at the end of the cycle, the light of the Display switches off and the LED Start/Pause flashes slowly.
Pressing any button or rotating the selector, the appliance returns to the normal status (following model MCF-file).

Selector

Function:

- There is an additional 6-position selector only with the TC5 model.
- **Spin speed selector**, by turning this selector, you can reduce spin-dry speed step by step down to zero, to rinse hold or to night cycle.
- Reduces the spinning speed of all spin-dry cycles.

1300	1100	900	700	0	Rinse hold
1200	900	700	500	0	Rinse hold
1100	900	700	500	0	Rinse hold
1000	900	700	500	0	Rinse hold
900	800	700	500	0	Rinse hold
800	700	600	500	0	Rinse hold
700	600	500	400	0	Rinse hold

- **Temperature selector**, by turning this selector, you can reduce temperature speed step by step down to colt.

adjust temperature	90°C	60°C	50°C	40°C	30°C	0°C
--------------------	------	------	------	------	------	-----



Push Buttons

Spin deselection button



Function:

- By pressing this key, you can reduce spin-dry speed step by step down to zero, to rinse hold or to night cycle.
- Reduces the spinning speed of all spin-dry cycles.

1000	700	500	0	Rinse hold
900	700	500	0	Rinse hold
800	700	500	0	Rinse hold
700	500	400	0	Rinse hold

Temperature button



Function:

- To activate the temperature button it is necessary to select a program.
- By pushing this button the washing temperature can be reduced to 0°C step-by-step.

adjust temperature	90°C	60°C	40°C	30°C	0°C
--------------------	------	------	------	------	-----

Time Manager-button

Function:

- By pushing the Time Manager key you can reduce the wash time depending on the degree of soilind.
- **LED Daily**, wash times in Cotton, Synthetics and Delicates cycles are reduced.
- **LED Light**, wash time in Cotton, Synthetics and Delicates cycles are reduced even further.
- **LED Short**, wash time in Cotton, Synthetics and Delicates cycles are modified for half the quantity.

Extra rinse button



Function:

- Two additional rinse cycles are added in the cycle cotton / coloured.
- One additional rinse cycle are added in the cycles synthetics, delicate fabrics and silk.
- No intermediate rinse, except after the last rinse cycle.

Delayed Start button



Function:

- By pushing the key for pre-selecting the time you can delay the start time.
- Depending on the model, you can select three different delay levels, e.g. 2h, 4h, 6h.
- Via the configuration of electronics it is possible to get various delay levels from 2h – 20h.
- Change of delayed start:
 - switch off the programselector
 - select a new program again

Start/ Pause button

Function:

- The selected program is activated by pressing the start/pause button.
The LED start/pause on.
- If the cycle is to be paused, press the start/pause button.
Start/ Pause-LED blinks. The program interrupt.
- This is not possible after a program run time of 10 min..

LED	status	process
start/pause	(green) ON	cycle is running (lid closed)
	(green) Flashing	cycle in pause position
	(red) Flashing	additional option key pressed, after program start. Err in display.
	OFF	

Options

The selection of the options is to be carried out after switching on the appliance and setting the desired programme with the selector and before pressing the start/pause button.

Programmes		Options																
		Rinse-hold	Night cycle	Pre-wash	Stains	Bleach	Extra rinse	Easy iron	Eco	Intensiv	Normal	Daily	Light	Quick	Super quick	Reduced spin speed	no spin	Half-load
Compatibility with programmes	Cotton	90°C	X	X	X	X	X	X	X	X		X	X	X	X	X	X	X
		60°C	X	X	X	X	X	X	X	X		X	X	X	X	X	X	X
		50°C	X	X	X	X	X	X	X	X		X	X	X	X	X	X	X
		40°C	X	X	X	X	X	X	X	X		X	X	X	X	X	X	X
		30°C	X	X	X		X	X	X			X	X	X	X	X	X	X
	cold	X	X	X		X	X	X			X	X	X	X	X	X	X	X
	Synthetic	60°C	X	X	X	X		X	X	X		X	X	X		X	X	X
		50°C	X	X	X	X		X	X	X		X	X	X		X	X	X
		40°C	X	X	X	X		X	X	X		X	X	X		X	X	X
		30°C	X	X	X			X	X			X	X	X		X	X	X
	cold	X	X	X			X	X			X	X	X		X	X	X	
	Delicates	40°C	X	X	X	X		X				X	X	X		X	X	X
		30°C	X	X	X			X				X	X	X		X	X	X
		cold	X	X	X			X				X	X	X		X	X	X
	Wool	40°C	X	X								X					X	
		30°C	X	X								X					X	
		cold	X	X								X					X	
	Easy iron	60°C	X		X			X	X			X					X	X
		50°C	X		X			X	X			X					X	X
		40°C	X		X			X	X			X					X	X
		30°C	X		X			X	X			X					X	X
	cold	X		X			X	X			X					X	X	
	Blanket	40°C										X					X	
		30°C										X					X	
	Jeans	60°C	X	X	X			X	X			X					X	X
		50°C	X	X	X			X	X			X					X	X
		40°C	X	X	X			X	X			X					X	X
		30°C	X	X	X			X	X			X					X	X
		cold	X	X	X			X	X			X					X	X
	Shoes	40°C	X	X	X			X				X					X	
		30°C	X	X	X			X				X					X	
		cold	X	X	X			X				X					X	
	Lingerie	40°C	X	X								X					X	X
		30°C	X	X								X					X	X
		cold	X	X								X					X	X
	Silk	30°C	X	X											X	X	X	
		cold	X	X											X	X	X	
	Baby, Sport intensiv	40°C	X	X	X			X				X					X	X
		30°C	X	X	X			X				X					X	X
		cold	X	X	X			X				X					X	X
	Sport light, Mi	30°C													X	X	X	
	Sanitär	90°C	X	X	X	X	X	X			X						X	X
	5 Shorts	30°C													X	X		
	MIX 40°-60°	40°C	X	X	X	X	X	X		X							X	X
	Hygiene +	90°C	X	X		X		X	X			X					X	X
		60°C	X	X		X		X	X			X					X	X
		50°C	X	X		X		X	X			X					X	X
40°C		X	X		X		X	X			X					X	X	
Rinses		X	X			X	X	X							X	X		
softener		X	X				X								X	X		
Conditioner		X	X					X							X	X		
Drain																		
Spin																X		
Gentle spin																X		

Function:



Rince hold

- The program is finish with water in the drum.
- In order to continue a program afterwards, you first have to select a separate draining or spinning.

Function:



Night Cycle

- The number of rinces are increase cotton/cotoured from three rinces to six rinces and synthetic from three rinces to four rinces.
- All rinces are without a spinphase.
- The programm is stopped in a rinse hold.
- In order to continue a program afterwards, you first have to select a separate draining or spinning.
- Switches off the buzzer (if configured)

Function:



Pre-Wash

- It is heated up to max. 30 ° C.
- Can't be combined with the programe wool, silk and sport 30.

Function:



Stains

- The selected temperature however must be $\geq 40^{\circ}\text{C}$.
- Separate rinsing in of stain remover through the pre-wash chamber, approx. 1.2 ltrs.
- Can't be combined with the pre-wash function.
- Extends the cycle duration in the main wash by 5 minutes after the first heating to 40°C .

Function:



Extra rinse

- Two additional rinse cycles are added in the cycle cotton / coloured.
- One additional rinse cycle are added in the cycles synthetics, delicate fabrics and silk.
- No intermediate rinse, except after the last rinse cycle.

Function:



Easy Iron 40°

With **cotton/coloureds** programmes:

- No intermediate spin-dry cycle.
- 3 additional rinse cycles.
- Pulse spin-dry
- Additional loosening phase after spin-drying

With **synthetics** programmes:

- Reduced wash temperature
- Prolonged wash time and prolonged cooling phase
- One additional rinse cycle
- Additional loosening phase after spin-drying

Function:



Energy Saving

- The washing temperature in the programs:
- $E90^{\circ}\text{C}$ is reduced to 67°C , the max. temperature kept constantly for a certain period of time.
- $E60^{\circ}\text{C}$ is reduced to 40°C , the max. temperature kept constantly for a certain period of time.
- $E40^{\circ}\text{C}$ is reduced to 40°C , the max. temperature achieved for a short moment.
- Can't be combined with the quick function.

Programselector

Depending on the model, the electronic may include a programselector with 15 or 21-positions. The programselector includes the “on/off” function and the wash programs.



Programme

Jeans



Function:

- The cycle includes a main cycle, five rinse cycles. (1. and 2. rinses without intermediate spins and 3., 4., 5. rinses with intermediate spins max.1200 1/min).
- The load amount is 3kg.
- Can be combined with the Night Cycle Pre-wash and Spin deselection button.

Shoes 30°, 40°



Function:

- The program consists of a main wash, three rinses without intermediate spins but with an end spin. (1000 1/min).
- It is heated up to 40 °C.
- Can be combined with the Quick, Extra rinse, Night Cycle, Pre-wash, Soaking and Spin deselection button.

Silk 30°



Function:

- The program consists of a main wash, three rinses without intermediate spins but with an end spin. (700 1/min).
- Washing time during main wash is 10 min.
- The load amount is 1kg.

Baby 30°, 40°



Function:

- The program consists of a main wash, three rinses with higher water levels without intermediate spins, but with an end spin. (700 1/min).
- The load amount is 2kg.

Sanitär 90°



Function:

- The program consists of a main wash, three rinses with intermediate spins but with an end spin. (1200 1/min).
- Washing temperature during main wash is kept constantly to 85° for 10 min.
- The load amount is 5,5kg.

Dessous 30°, 40°



Function:

- The program consists of a main wash, three rinses without intermediate spins but with an end spin. (900 1/min).
- The load amount is 1Kg.

Blanket 30°, 40°



Function:

- The program consists of a main wash, three rinses with higher water levels (20ltr.) intermediate and end spin. (650 1/min).
- The load amount is 2,5kg.

Soak



Function:

- The soaking period begins with pre-wash and soaks for about the next 30 minutes.
- Can't be combined with the function pre-wash.
- It is heated up to 30 °C.
- A short spin cycle is performed in the cycles COTTON and SYNTHETICS, before passing on to the main wash.
- You can prolong soaking time for max. 0h, 30', 60', 90', 2h - 10 h using the „Start preset“ key.
- After pressing the start key, the duration of the cycle is displayed by hours and minutes.

Sport light 30°



Function:

- The program consists of a main wash, two rinses with higher water levels without intermediate spins, but with an end spin. (700 1/min).
- The load amount is 2kg.

Sport intensiv 30°, 40°



Function:

- The cycle consists of prewash, higher water level, heating to 30° and spin cycle to 650 1/min, one main wash, two rinse cycles without intermediate spin with higher water level but with final spin (900 1/min).
- The load amount is 2,5kg.

Buzzer, Extra rinse cycle, Child safety

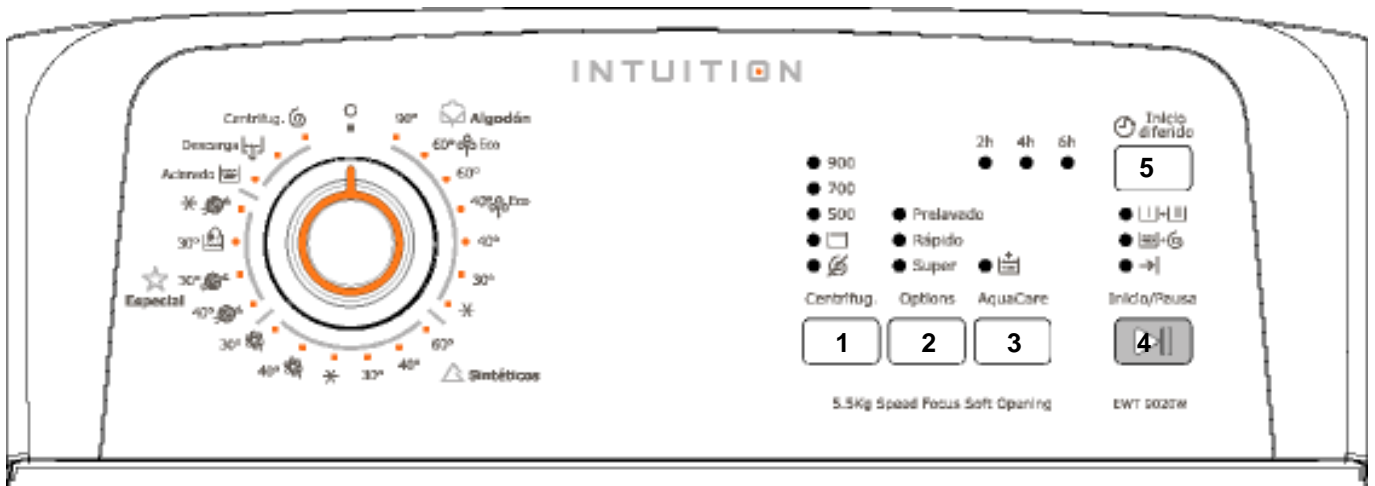

Activation and deactivation of the buzzer:

Function:

- Depending on the model, the electronic may include a buzzer.
- Switch off the appliance.
- Hold buttons 4 and 1 pressed simultaneously and turn the program selector one position to the right. The buzzer is activated.
- You can deactivate the buzzer by repeatedly pressing the key combination.

Activation and deactivation of the extra rinse cycle:

Function:

- If no extra rinse key is available, you can select extra wash.
- This button is effective in the cycles cotton/coloured wash, synthetics and delicate fabrics.
- Two additional rinse cycles are added.
- No intermediate rinse, except after the last rinse cycle.
- Switch off the appliance.
- Hold buttons 2 and 1 pressed simultaneously and turn the program selector one position to the right. The extra rinse is activated.
- You can deactivate extra wash by repeatedly pressing the key combination.

Activation and deactivation of the child safety:

Function:

- The child safety function can be activated at the start of the program and also after the program has started.
- Keep key 3 and key 2 pressed simultaneously until the LED is lit.
- The option is activated, the initiated wash program runs normally through and on completion any further function of the appliance is disabled. The option remains saved when the appliance is turned off.
- You can deactivate child safety by repeatedly pressing the key combination.



Functions of the System

Electronic EWM1100 with universal motor AC

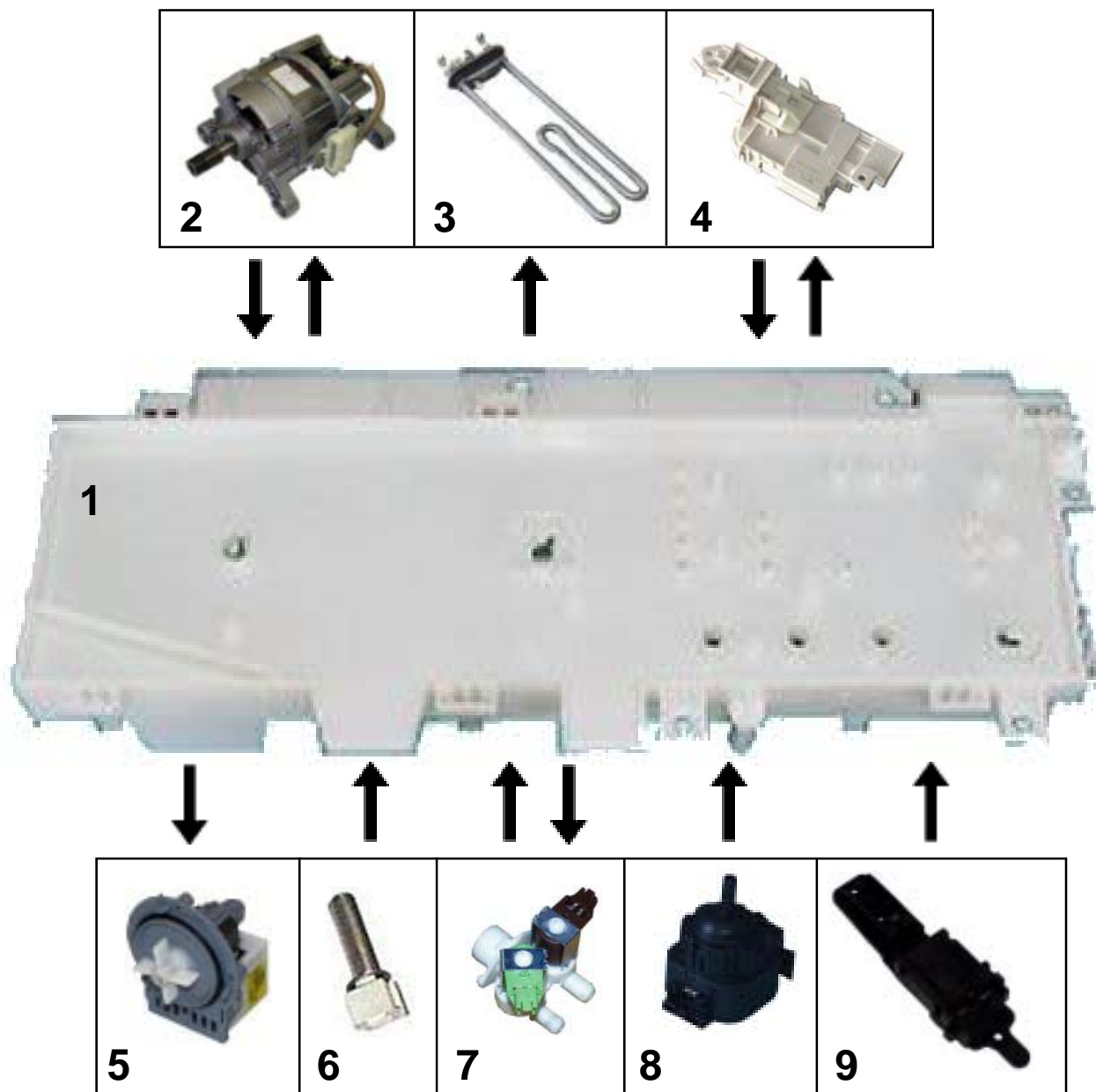

1. electronic module
2. motor
3. heating element
4. door security
5. drain pump
6. NTC-sensor
7. inlet valve
8. analog pressure switch
9. drum self position (DSP)

Connection cable electronic

Electronic EWM1100

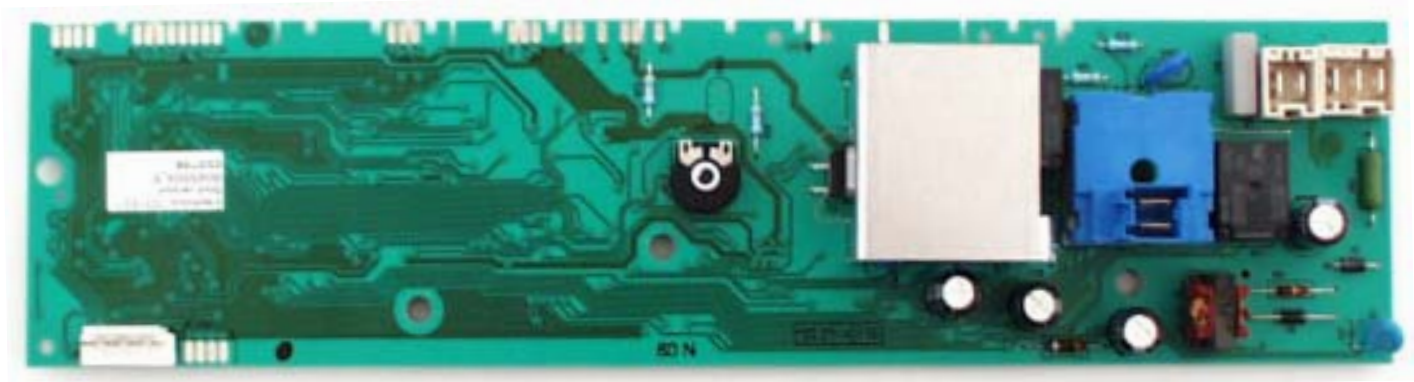

1. drum self position (DSP)
2. analogic pressue switch
3. NTC-sensor, Inlet valve
4. motor, drain pump
5. Power supply 230V
6. heating element
7. door security

Electronic Module

The electronic module, including the μP , controls various functions and is placed in a protective housing.

It is the communication interface between the user and the appliance.

It consists of:

- The option buttons.
- The programselector with 15 or 21-positions.
- A selector for temperature or spin speed (only with TC5 appliances).
- The "Start/Pause" button.



Functions:

- Taking data of the selected cycle programs through the module.
- Water level control (antifoam, overflow level) in the tub; the level is recognized by the analog pressure switch.
- Cycle temperature control by a NTC sensor.
- Power supply of the heating element.
- Power supply of the drive motor (EWM1100) and control of its speed by the tachymetric generator.
- Control of water inlet valves.
- Control of drain pump, door lock and DSP (drum self position).

In case of a power failure the module saves the just paused cycle.

- When the power supply to the appliance is restored again, the cycle starts where the program was paused.

Door Lock

3 = N
4 = electronic J1-2
5 = L

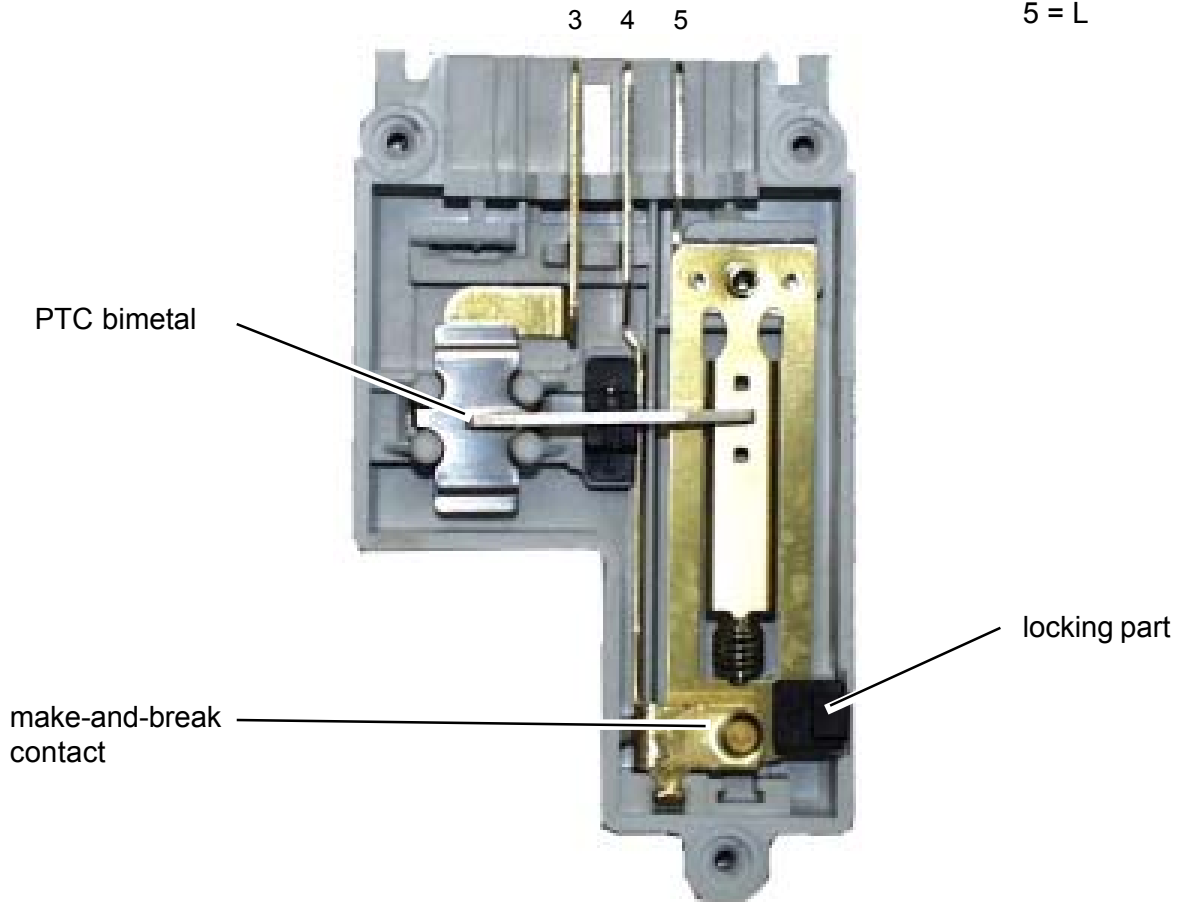

When closing

When the washing programme is started by pressing the START/ PAUSE button, the bi-metal PTC (contacts 3-5) is powered by the triac on the PCB: after 2-4 seconds, this closes the switch (5-4) which powers the electrical components of the appliance (only if the door is closed).

When opening

At the end of the washing programme, the PCB disconnects the interlock from the power supply, but the door remains locked for 1 to 2 minutes (PTC cooling time).

If there is a **power failure** during a wash cycle, the door lock requires approx. 2 min until the lid can be opened. During this time the PTC bimetal cools down and the locking part opens.

Circuit Diagram

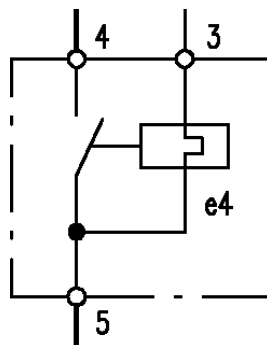

Security:

(see page **Service - Program** fault display E40)

DSP (Drum-Self-Position)

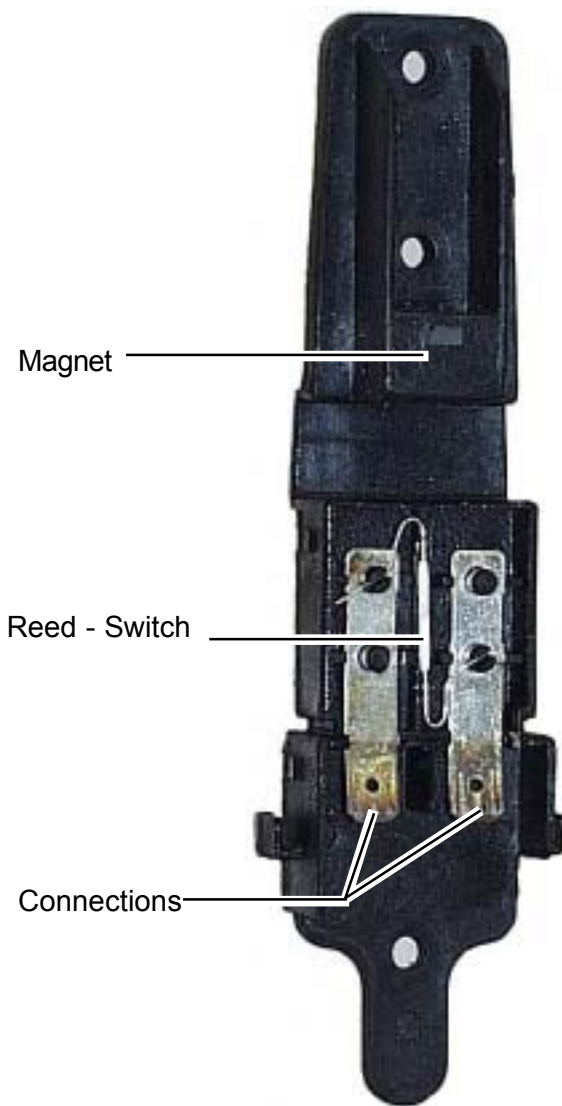

Control (check) the DSP-Function:

1. Remove the two plugs from the DSP and check the resistance of the reed relay.
 - Turn the drum to the right position ---> $> 0\Omega$
 - Turn the drum over the right position ---> 0Ω
2. The drum is still in the right position. Now measure the voltage. 5-6V DC
 - If there is no voltage ---> Cable, Main electronic board is defective
3. Check the In / Output electronic in the customers service test program.
 - LED on ---> In / Output electronic OK.
 - LED off ---> In / Output electronic defective.

Function:

The reed relay is closed if the metallic sheet, located on the pulley, isn't between the magnet and the reed relay. If the position of the metallic sheet is between those parts the contact of the reed relay is opened.

To mount the pulley in the correct way, you have to take care about following items:

The metal sheet located on the pulley should be in the drum self positioning device, if the door of the drum is in the upper position. The DSP is supplied with 5-6 V DC by the main board.

Condition drum positioned:

Reed contact opened, 5-6V DC.

Condition drum out of position:

Reed contact closed, 0V DC.

If the washing cycle is interrupted by the start pause button the drum has to be positioned within 10 sec. During this time 2-3 attempts can be executed. If the drum isn't positioned during this time, the lid of the appliance is released and can be opened. The LED drum positioned is not illuminated. At the end of the cycle the positioning phase is 2 min until time out is reached.

Float switch

The float switch is made of a housing with a micro switch and a float body.

Function:

The float switch is located in the bottom tray. The bottom tray is constructed in a way that the water is gathering in the area of the float switch in case of leaky components (tub, hoses, etc.). The float body comes up and switches a micro switch. This selects the drain pump, the existing water in the tub is drained. The inlet valve is switched off.

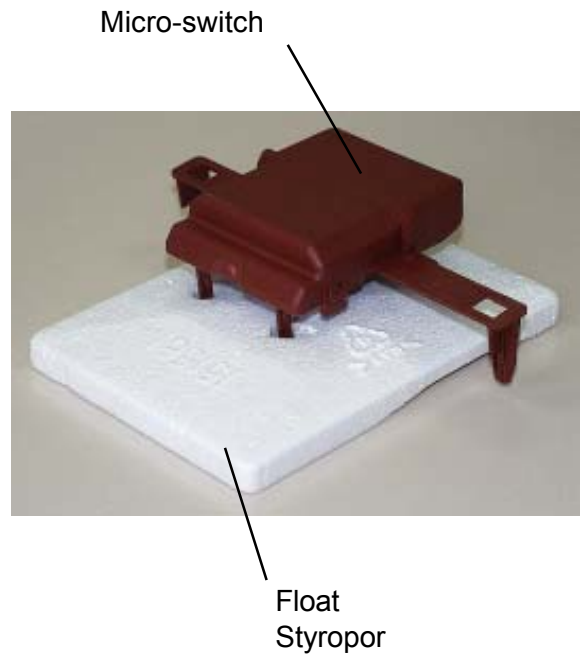

Inlet valve

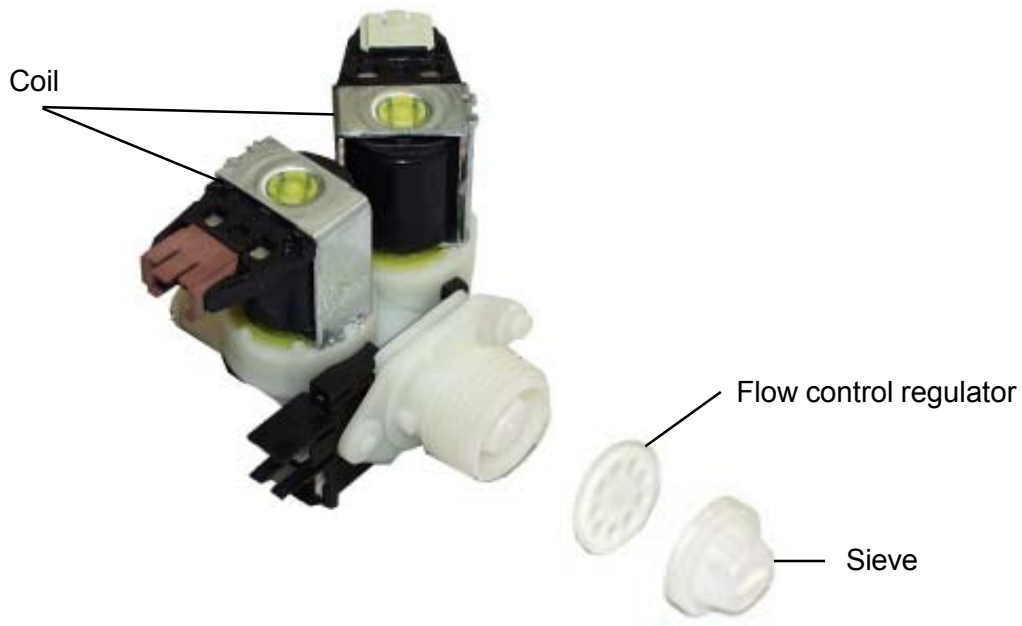

The automatic washing machine is equipped with a double inlet valve. A valve controls the water inlet for the prewash chamber, the second valve controls the water inlet for the main wash chamber. The filling via the softener chamber is achieved by selecting both valves. The water pressure of > 1 bar is limited by the volume regulator to $5.5 \text{ l/min} \pm 15\%$. (see Page **Service - Program** fault display EC1)

Water Inlet Valve for 3-chamber detergent box



- 1 - connection water inlet hose
- 2 - inlet valve, 2-fold
- 3 - hose for pre-wash
- 4 - hose for main wash
- 5 - water distributor
- 6 - hose for fluff filtre

***) Attention!**
The simultaneous filling through hoses 3 and 4 provides the fill-in through the softener chamber.

Water Distributor

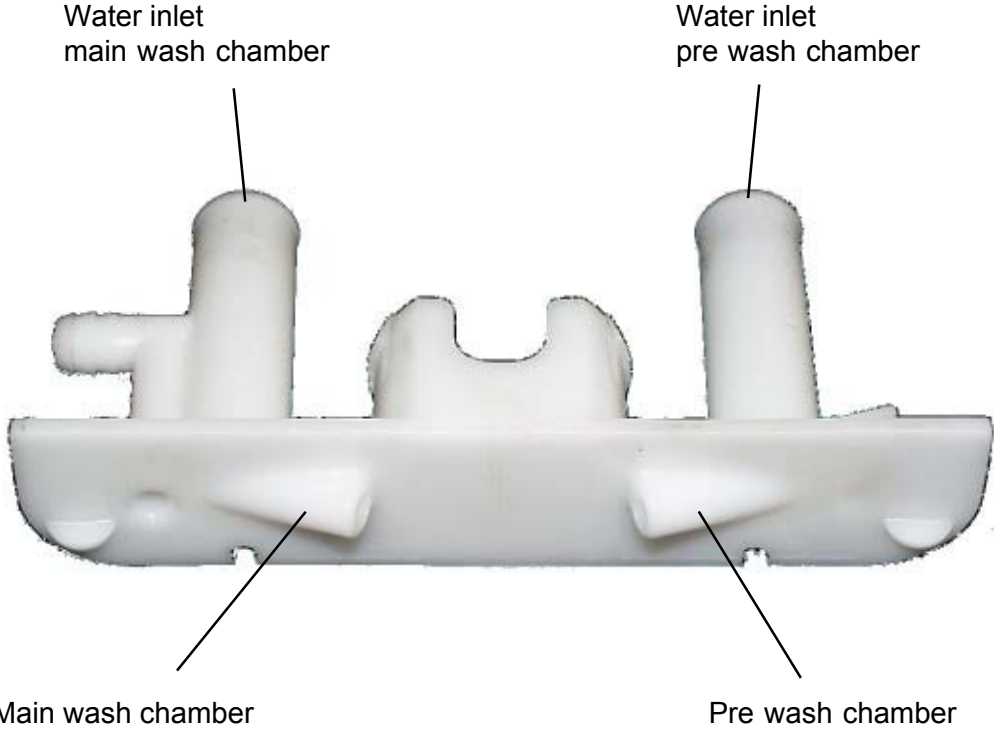

Analogic pressure switch

The analogic pressure switch controls the water level in the tub, it is directly connected to the electronic modul.

If the pressure switch does not work correctly, the programm in progress is cancelled:

1. Pressure switch hose connection
 2. Diaphragm
 3. Coil (self)
 4. Electronic circuit (oscillator)
 5. Magnet
 6. Spring
 7. Adjusting screw
 8. Connector
- Kontakt 1 = Out
Kontakt 2 = GND
Kontakt 3 = 5V DC

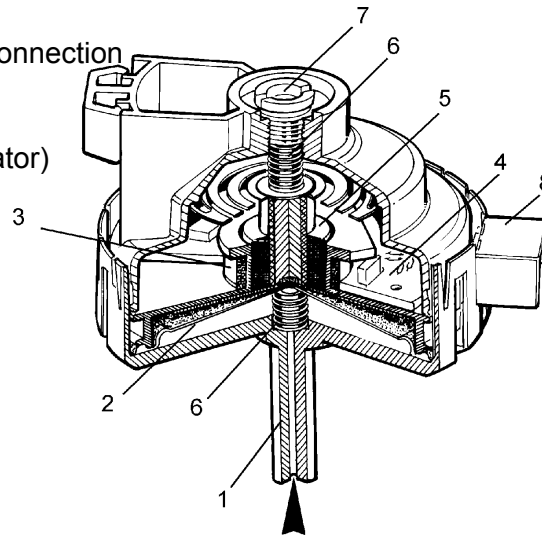

When the tub is full, the pressure inside the hydraulic circuit acts on the diaphragm which moves the magnet inside the coil.

This moving modifies the inductance of self and consequently the frequency delivered by the scillatory circuit. the μP , after frequency reading, recognizes the water level inside the tub. (see Page **Service - Program** fault display E30)

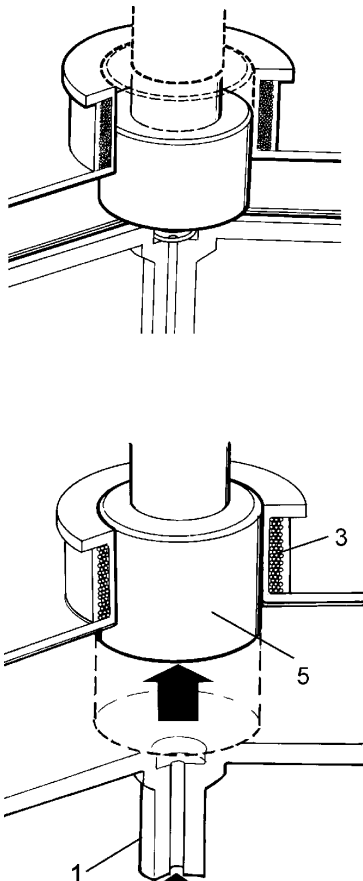

Frequency delivered follow the pressure (± 50 Hz)

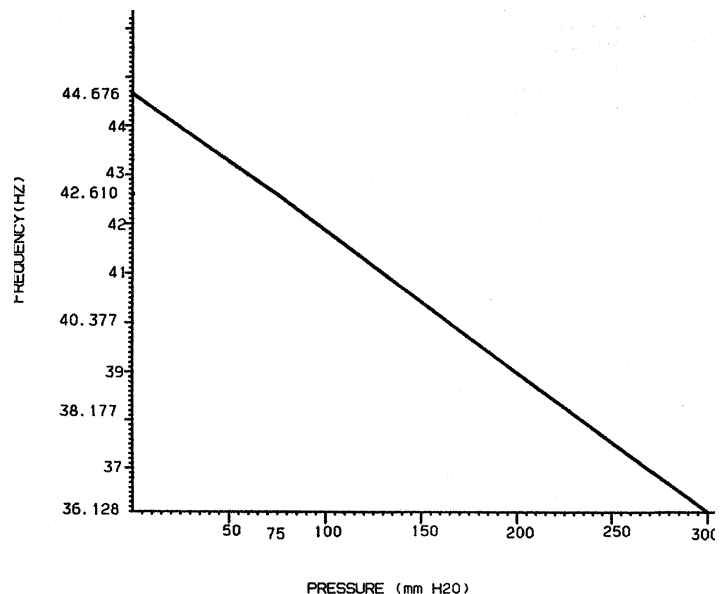

Heating element



Connection: 230V; 50Hz;
 Power: 1950W
 Fuse: 10A

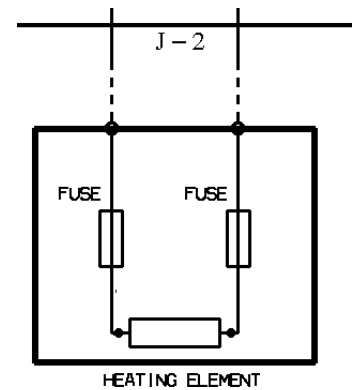

The heating element is supplied with power directly from the control electronics by means of a relay. For security reasons, 2 switching contacts of the pressure switch are connected in series. The switching positions are monitored by control electronics via 2 control lines.

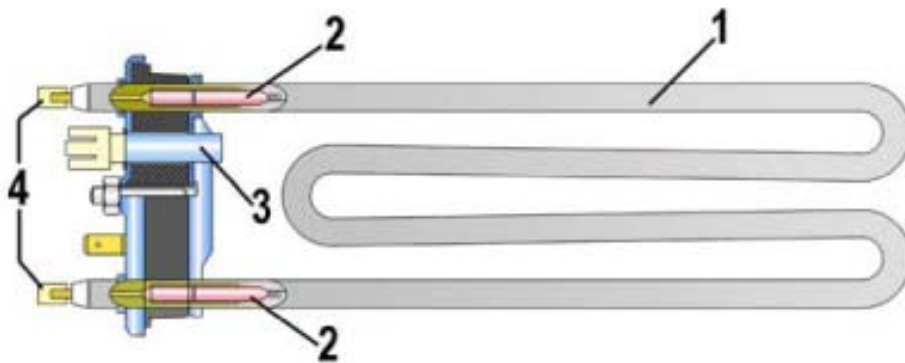

1. Heating element
2. Temperature fuse
3. NTC-sensor
4. Connection

Check of insulation resistance with the heating

Wash a cycle for approx. 10 minutes. Switch off the appliance, unplug the plug and remove the side panel.

Draw off the connecting lines from the heater.

Measure the resistance between heating (depending on connection) and mass.

Resistance > 200 kOhm → heater OK.

Resistance < 168 kOhm → error E68

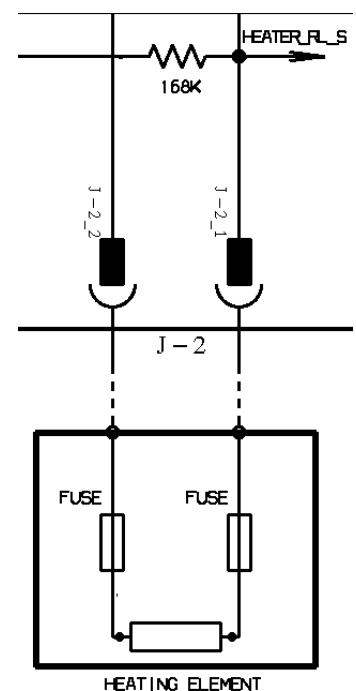

Heating Circuit

The cycle temperature is fixed by the μP depending on the selected program.

The temperature control is guaranteed by the μP through the NTC temperature sensor. The temperature sensor reduces its resistance according to the temperature increase.

The reduction in the ohmic value of the temperature sensor is detected by the μP ; as soon as the selected temperature is reached the power supply to the heating element will be paused.

The NTC sensor is integrated in the heating element.

NTC-Sensor

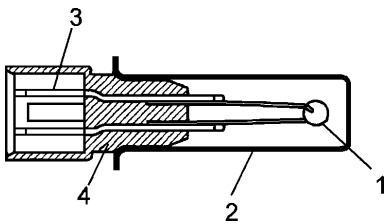

1. NTC resistance
2. Metallic casing
3. Connections
4. Plastic casing

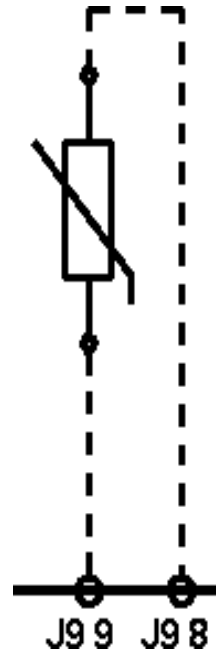

To check the NTC sensor function you can measure the ohmic resistance between the contacts J9/8 and J9/9.

Variations of NTC resistance

Temperature ($^{\circ}\text{C}$)	Resistance (Ohm)
25	4815 \pm 207
40	2563 \pm 102,5
60	1196 \pm 26,31
80	602 \pm 19,89

Security

- The μP will be break off if an anomaly on the termistance circuit is detected : cut or short-circuit. (see Page **Service-Program** fault display E70)
- The heating phase is not executed.

Drain pump

The drain pump is directly controlled via triac from the control electronics.

Motor

Electronic EWM1100

The motor is directly phase-controlled via triac from the control electronics.

Relays K2, K3 are responsible for commuting the sense of rotation.

Field switching (if any) is controlled by relay K4.

Speed is monitored by tachometer generator g1 and controlled by control electronics.

Integral overheat protection disconnects the motor from power supply at 115°C.



Connection:

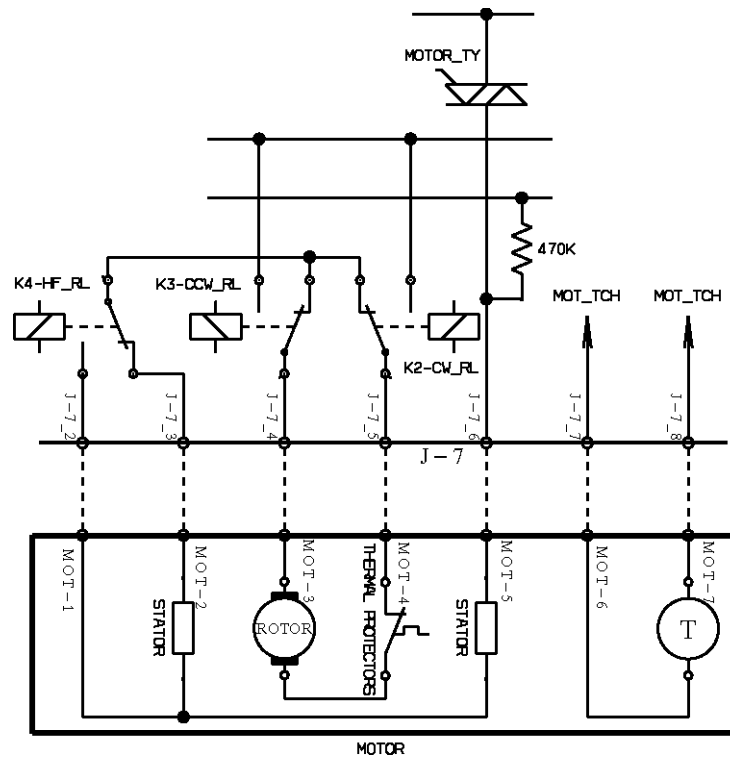

Safety

- If the triac for the motor is in short-circuit, or if the tachometer generator is interrupted, 4 trials are executed in intervals of 5 minute each. After a break of 20 minutes, the fifth and last trial is started. If the motor does not run this time, the programme is aborted. (see Page **Service-Program** fault display E60)

Drum movements

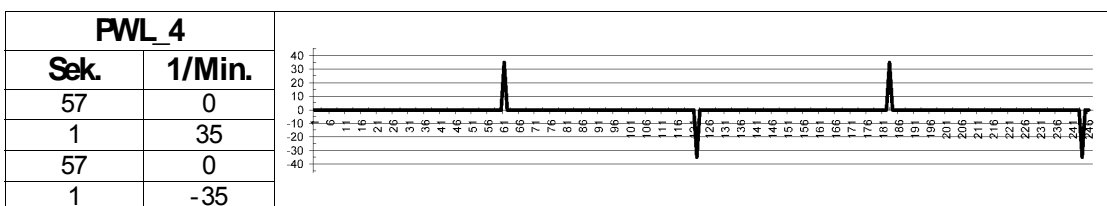
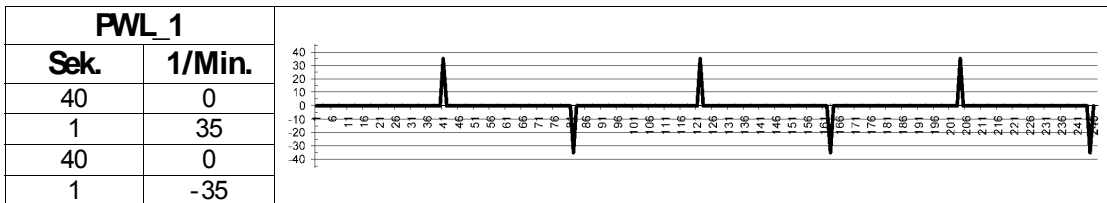
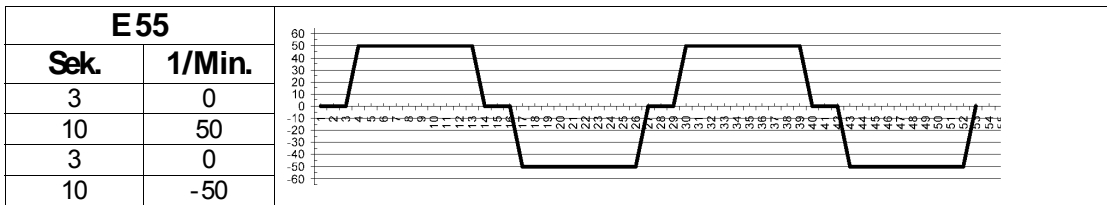
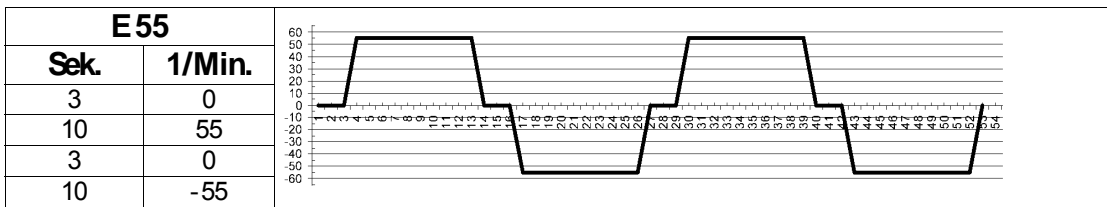
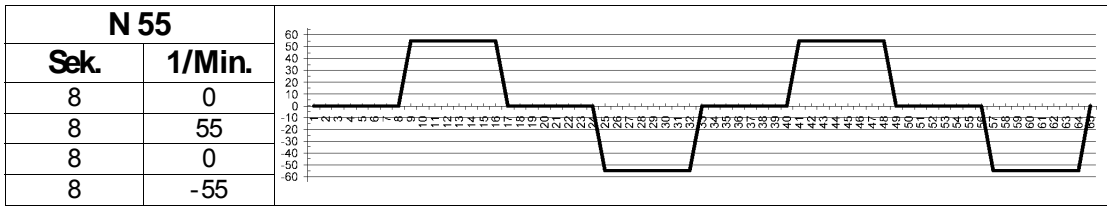
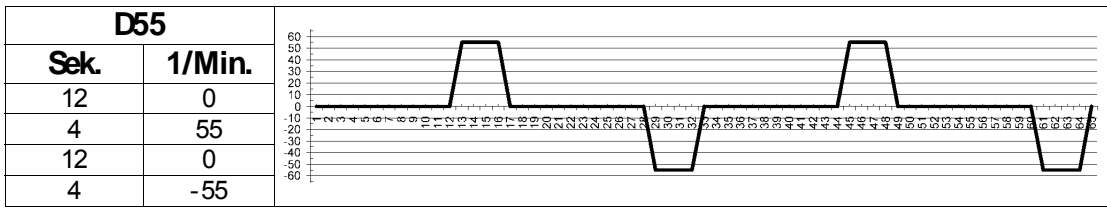

Spin profiles

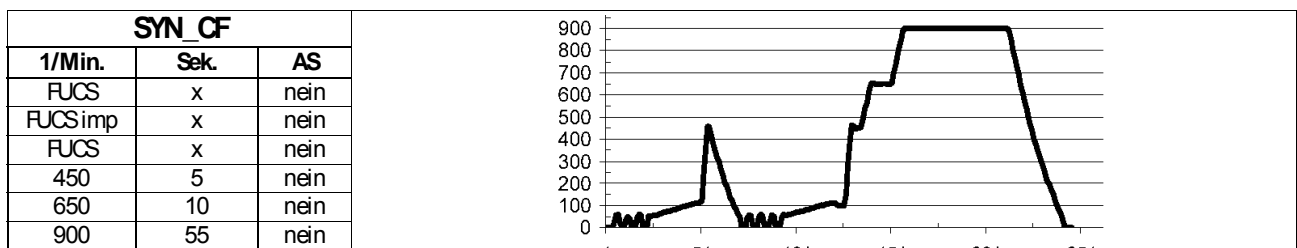
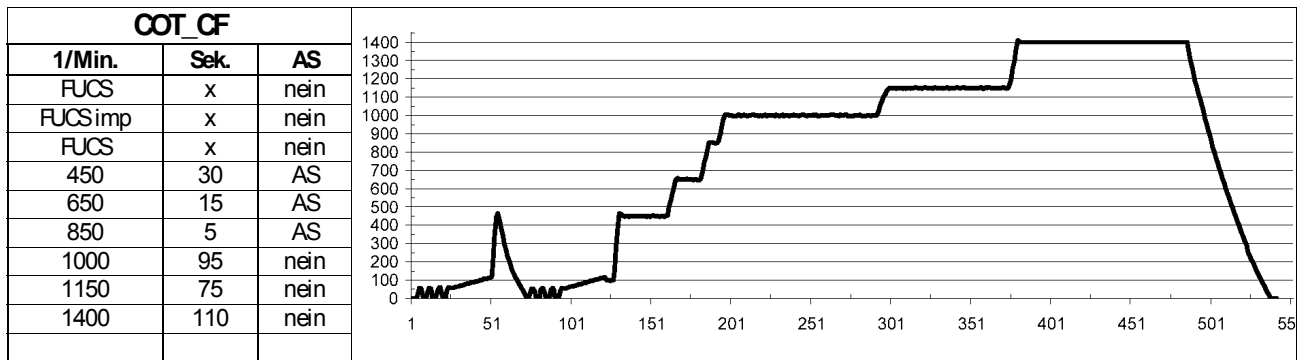
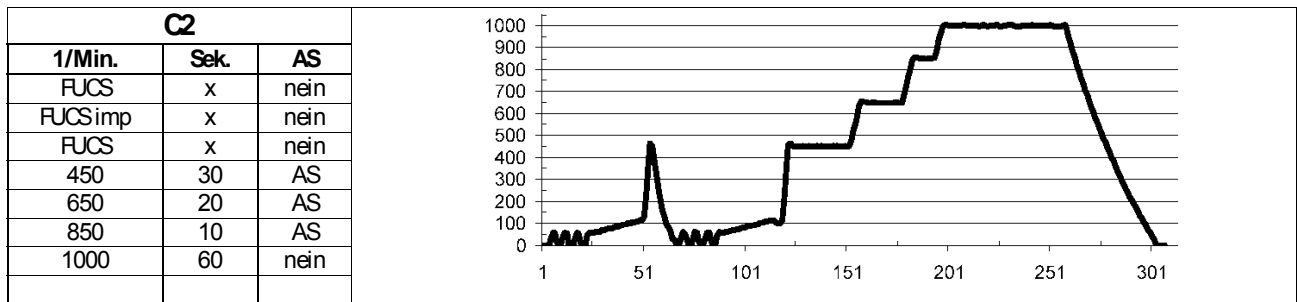
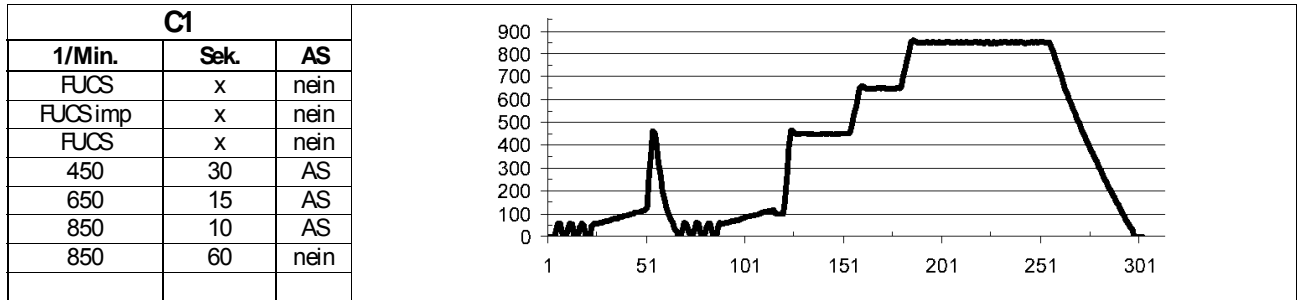
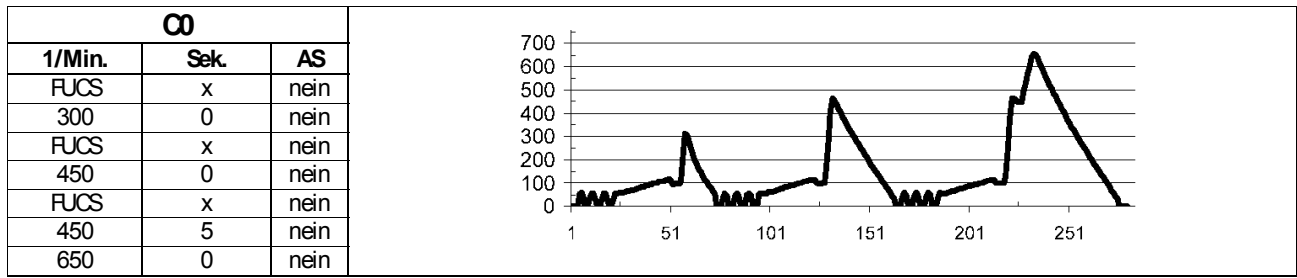

Spin profiles

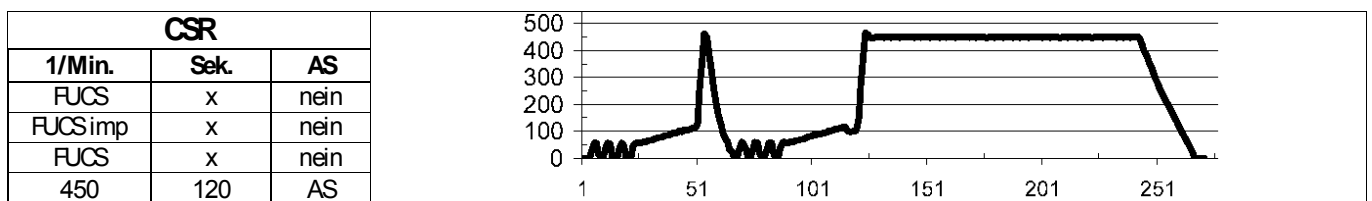
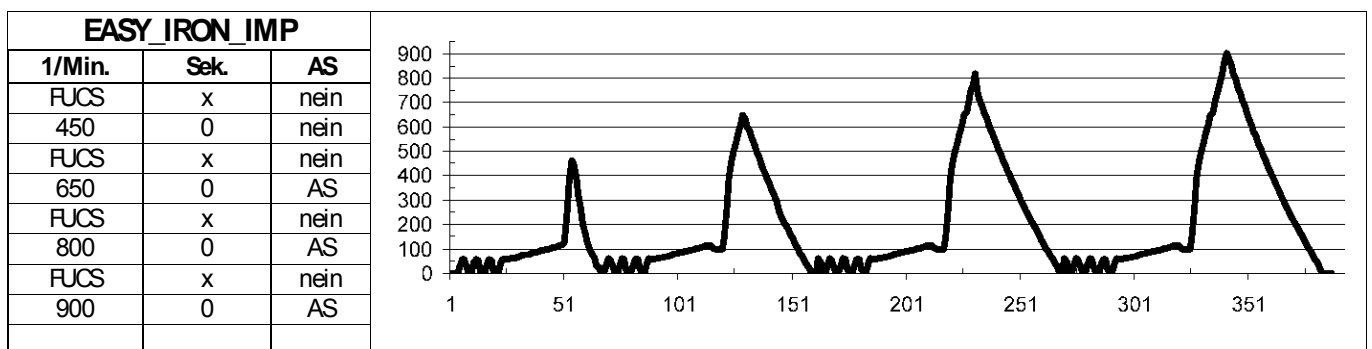
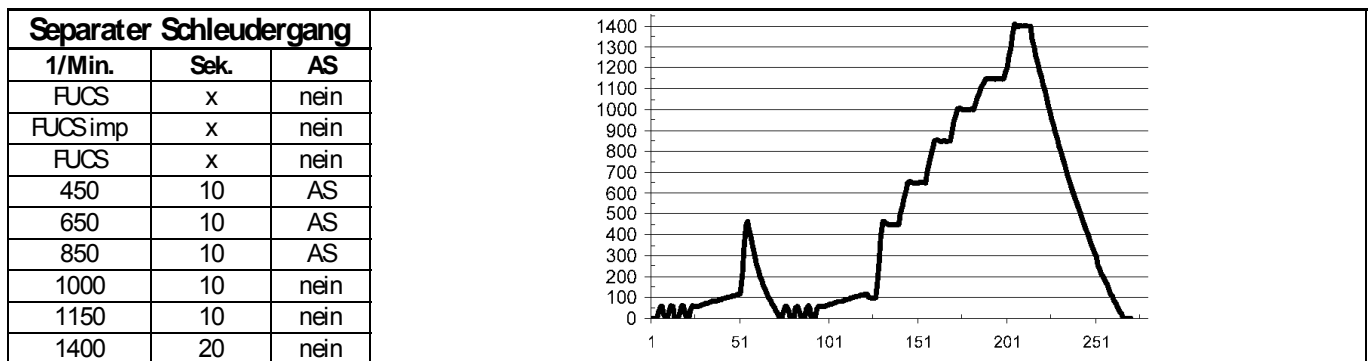
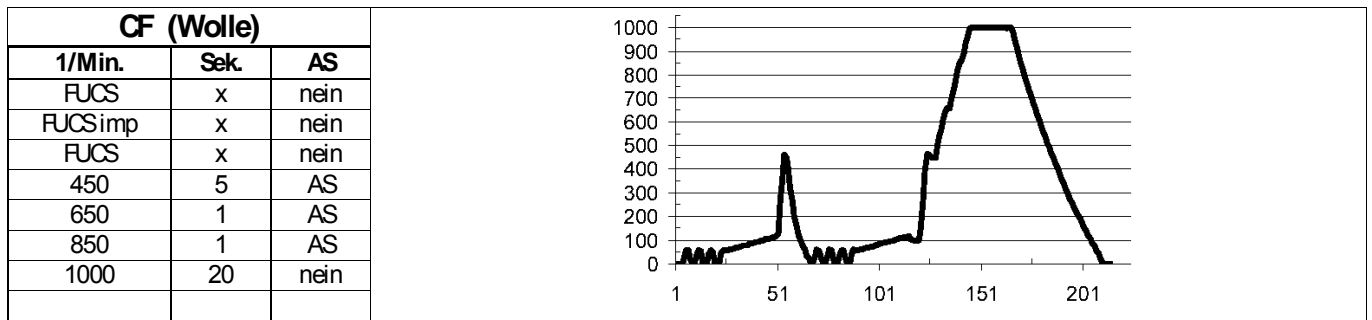
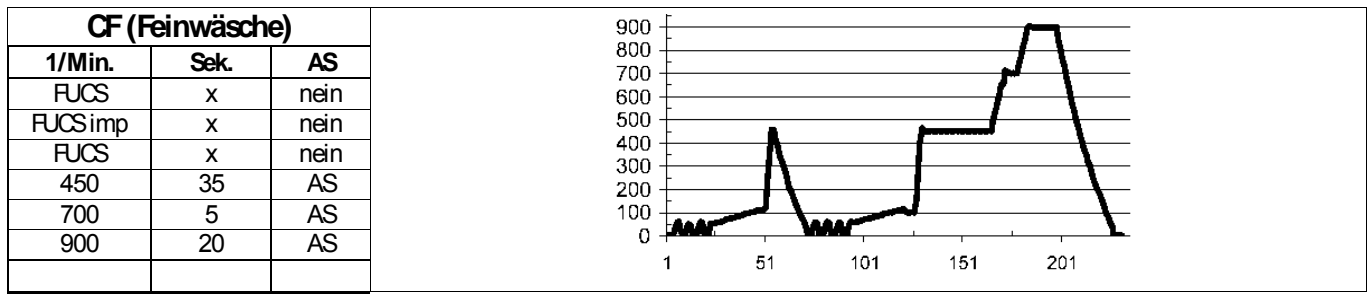

AS indicates that the anti-foam function is active.

Function of the FUCS

“FUCS” is an English expression and means “Fast Unbalanced Control System”

Function:

The unbalance control includes 4 phases. These phases are of different duration and have different limits of unbalance. The magnitude of the unbalance is calculated every 300 ms, hereby the magnitude is compared to the fixed unbalance limits, and then it is decided whether the speed will be increased or reduced by 2 1/min. FUCS starts at 55 1/min and ends ideally when reaching 115 1/min.

- Phase 0: When the unbalance threshold (850gr.) of the first phase is reached, the appliance performs a spin cycle with 100 1/min for 5 sec followed by a spin cycle pulse of 470 1/min.
- Phase 1: The first phase (350gr.) takes max. 120 sec to obtain the required speed of 115 1/min. If the speed is not reached after this 120 sec, the spinning cycle will be stopped. The laundry is dispersed and it is changed to phase 2.
- Phase 2: Phase 2 (650gr.) takes max. 60 sec. Here it is tried to obtain the speed of 115 1/min with various unbalance limits. If the speed is not reached after 60 sec, the spinning cycle will be stopped again. The laundry is dispersed and it is changed to phase 3.
- Phase 3: In phase 3 (1100gr.), the required speed is reduced to 85 1/min. Within 90 sec, speed should be reached, the machine then runs a spin-dry cycle at 100 1/min for 5 sec. and a subsequent spin-dry pulse at 470 1/min, then again starting by phase 1. If the speed is reached, a reduced spin-dry cycle at 650 1/min is carried out. If the speed is not reached, spin-dry is skipped.

Perfect balance

- Reversing
- FUCS phase 0 with spin-dry pulse
- Reversing
- FUCS phase 1
- regular spin-dry

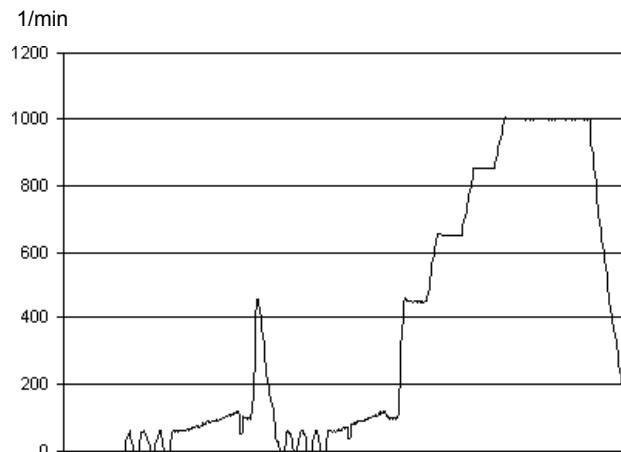

Balancing after two attempts

- Low speed
- FUCS phase 0
- FUCS phase 1
- FUCS phase 2

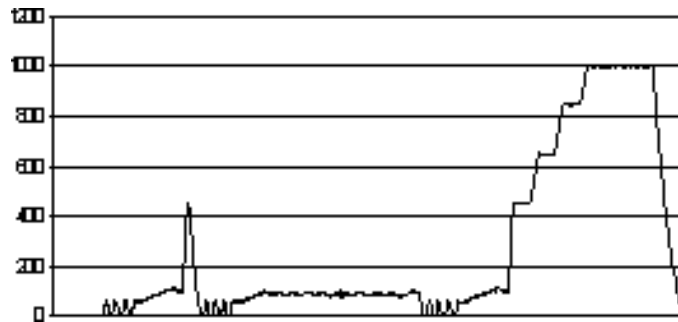

Balancing after the third phase (normal spin-speed)

- FUCS phase 0 with spin pulse
- FUCS phase 1
- FUCS phase 2
- FUCS phase 3 with spin pulse
- FUCS phase 1
- FUCS phase 2
- FUCS phase 3
- Normal spin

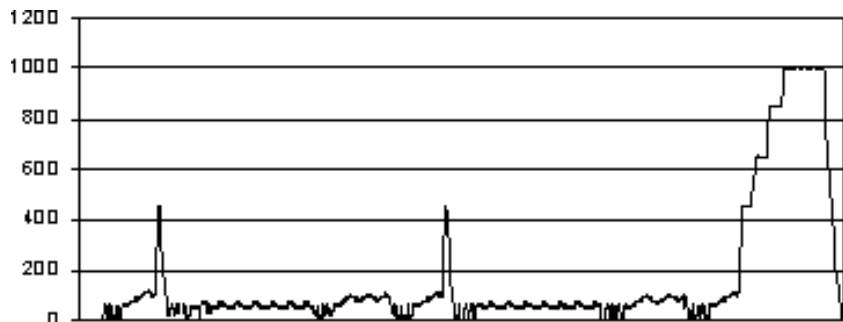

Balancing after the third phase (reduced spin-speed)

- FUCS phase 0
- FUCS phase 1
- FUCS phase 2
- FUCS phase 3 with spin pulse
- FUCS phase 1
- FUCS phase 2
- FUCS phase 3
- reduced-speed spin

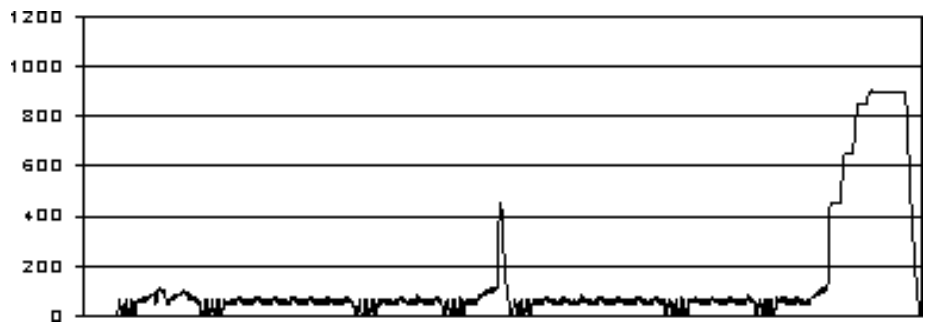

Unalancing after the third phase

- FUCS phase 0
- FUCS phase 1
- FUCS phase 2
- FUCS phase 3
- FUCS phase 1
- FUCS phase 2
- FUCS phase 3
- no spin

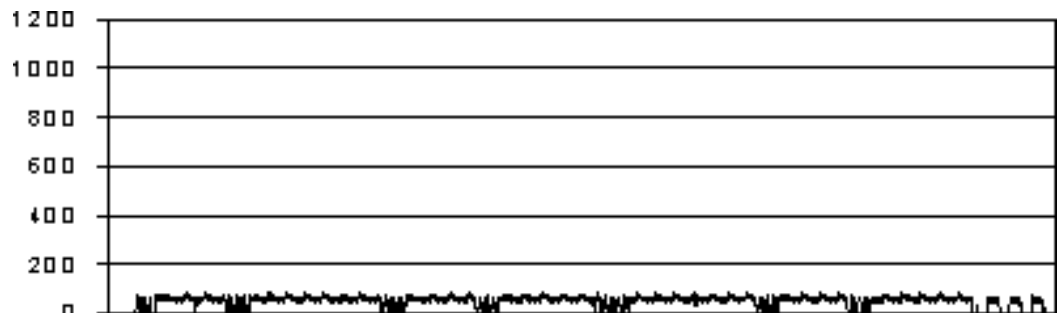

Foam Detection

Anti-foam control is excited via analog pressure switch.

Spin-dry phase without foam:

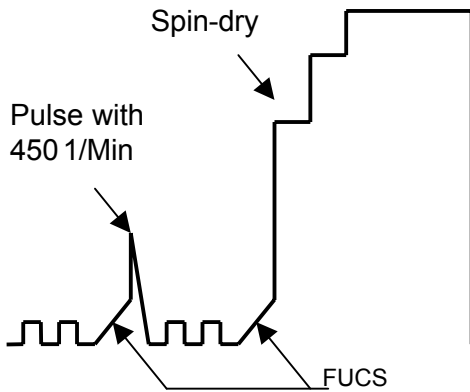

Spin-dry phase with little foam:

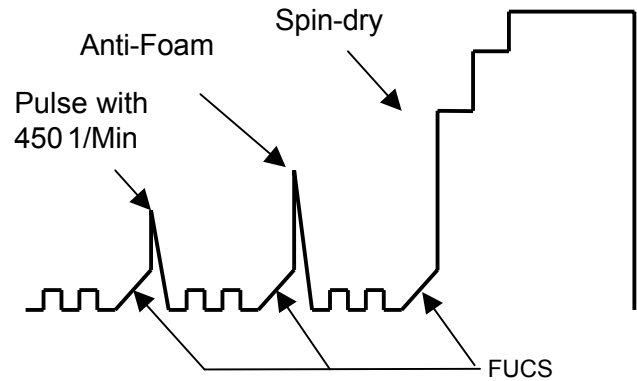

Spin-dry with little foam:

When the analogous pressure switch detects foam (45 mm "full"), the spinning cycle is stopped and the drain pump keeps on running until the foam level will be fallen below (15 mm "empty") and the spinning cycle is continued.

Spin-dry with excess foam:

When the analogous pressure switch detects a foam 5 times (45 mm "full"), the spinning will be skipped. Draining is carried out for 1 minute with the motor at stop. If too much foam is detected during any wash cycle, an additional rinse cycle is added.

Service Program

Fault indication by start / pause LED

- Switch off the appliance.
- Hold buttons 4 and 3 pressed simultaneously and turn the program selector one position to the right.
- Hold the two selected buttons pressed until possibly a buzzer will sound and/or the LED will give a light.
- By the program selector it is possible to interrogate the desired checking function according to the table.

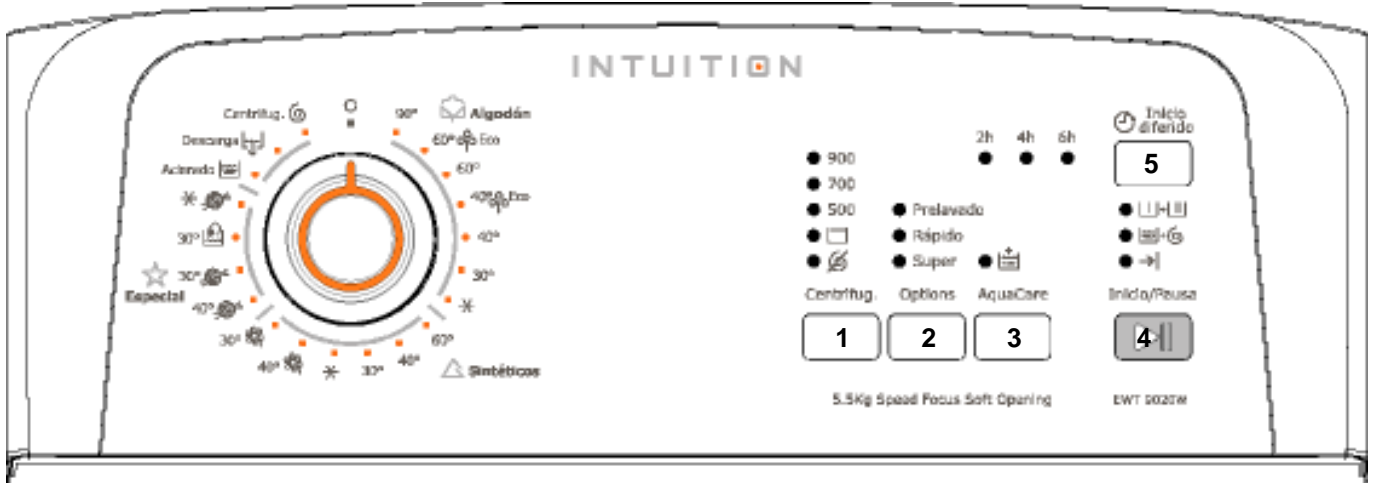

Position of the rotary switch	Button	Test function
Off		Off
21 - 15 Positions		
01	Button 4 and Button 3	1) Start of the customer service testprogram 2) LED - Test LEDs are step by step illuminated. If you press a button the according LED is on.
02		Water channel mainwash Water intake up to safety level fS Time max. 5 min Valve mainwash
03		Water channel prewash Water intake up to safety level fS Time max. 5 min Valve prewash
04		Water channel softener Water intake up to safety level fS Time max. 5 min Valve mainwash and prewash
05		Water channel spots Water intake up to safety level fS Time max. 5 min Valve spots or hotwater
06		Heating and circulation pump Heating up to 90°C Time max. 10 min Water intake over mainwash chamber
07		Tub leakage test Water intake over mainwash chamber up to 1. Niv. Motor rotation 250 1/min
08		Draining and spinning Draining Spinning up to maximum spin speed, if level < fSch
09		DSP The drum is positioned if level < fSch
10		Displaying the error code

Service Program

Fault indication by start / pause LED

Fault code	Type of fault	Remedy	Alarm Code	E N V 0 6											
				E	W	M	2	0	0	0	0	E	N	V	0
E60	E61	Insufficient heating Maximum heating time expired NTC defective Heating element defect Connection heating element interrupted	3	E W M 3 0 0 0 0 0											
				E	W	M	3	0	0	0	0	0	0	0	0
E62	Overheating: Temperature greater 88°C for a time longer than 5 min NTC defective Cable defective	Replace NTC Replace heating element Replace cable	2	E W M 2 0 0 0 0 0 0 0 0 0 0 0											
				E	W	M	2	0	0	0	0	0	0	0	0
E66	Heating element defect Incongruence between antiboil 2 and relay	Replace NTC Replace heating element Replace cable	2	E W M 2 0 0 0 0 0 0 0 0 0 0 0											
				E	W	M	2	0	0	0	0	0	0	0	0
E66	Heating element defect Incongruence between antiboil 1 and relay	Replace NTC Replace heating element Replace cable	2	E W M 2 0 0 0 0 0 0 0 0 0 0 0											
				E	W	M	2	0	0	0	0	0	0	0	0
E68	Leakage current in the appliance too high.	Replace heating element or replace other components	7	E W M 7 0 0 0 0 0 0 0 0 0 0 0											
				E	W	M	7	0	0	0	0	0	0	0	0
E70	NTC short circuit NTC interruption	Replace NTC, Replace electronic Replace cable	3	E W M 3 0 0 0 0 0 0 0 0 0 0 0											
				E	W	M	3	0	0	0	0	0	0	0	0
E74	NTC isn't in the correct position in the tub	Check the position	3	E W M 3 0 0 0 0 0 0 0 0 0 0 0											
				E	W	M	3	0	0	0	0	0	0	0	0
E80	Wrong selector reset position detection Wrong selector reading	Replace electronic Wrong configuration of the machine Replace electronic	4	E W M 4 0 0 0 0 0 0 0 0 0 0 0											
				E	W	M	4	0	0	0	0	0	0	0	0
E84	Recirc. pump sensing failure Input voltage always 0V or 5V	Replace electronic	1	E W M 1 0 0 0 0 0 0 0 0 0 0 0											
				E	W	M	1	0	0	0	0	0	0	0	0
E85	Recirculation pump defect Triac defective	Replace recirculation pump Replace electronic	2	E W M 2 0 0 0 0 0 0 0 0 0 0 0											
				E	W	M	2	0	0	0	0	0	0	0	0
E90	Interrupted communication between In/Output electronic and main electronic Incongruence between In/Output electronic and electronic	Replace cable, Replace electronic Replace In/Output electronic	0	E W M 0 0 0 0 0 0 0 0 0 0 0 0											
				E	W	M	0	0	0	0	0	0	0	0	0
E92	Incongruence between In/Output electronic and electronic with electronic	In/Output electronic is incompatible with electronic	1	E W M 1 0 0 0 0 0 0 0 0 0 0 0											
				E	W	M	1	0	0	0	0	0	0	0	0
E93	Configuration error	Wrong configuration of the machine	1	E W M 1 0 0 0 0 0 0 0 0 0 0 0											
				E	W	M	1	0	0	0	0	0	0	0	0
E94	Lost of cycle datas	Wrong configuration of the machine Replace electronic	1	E W M 1 0 0 0 0 0 0 0 0 0 0 0											
				E	W	M	1	0	0	0	0	0	0	0	0

Service Program

Fault indication by start / pause LED

Fault code	Type of fault	Remedy	Alarm Code		E W M 2 0 0 0 0 0		E W M 1 0 0 0 0 0 0		E W M 1 0 0 0 0 0 0		E W M 2 0 0 0 0 0 0		E W M 2 3 0 0 0 0		E N V 0 6		
			2 A	S	6 A	2 A	0	0	0 A	0 A	0 A	2 A	2 A	X	X	X	X
EC0	EC1	Inlet valve blocked	Replace inlet valve, Replace electronic														
	EC2	Turbidity sensor defect	Replace wiring														
EF0	EF1	Filter dirty Drainhose closed Time for draining to long	Replace turbidity sensor Cleaning drainhose and filter Checking drainpump														
	EF2	Detergent overdosing Too much foam during the drain phase Filter dirty Drainhose closed	Cleaning drainhose and filter Checking drainpump Not overdosing														
EF3		Aqua Control system activated	Leakage in the machine														
		Drain pump cable defective Drain pump interruption	Replace cable Replace drain pump														
EF4		No signal from flow meter with electro valves switched on	Water tap closed or mains pressure insufficient.														
EF5		Interrupted the spinning phase Unbalance to high, unbalance >1200gr	Pay attention to the quantity of laundry, check stationary behaviour of washer														
EH0	EH1	Power supply frequency out of limits	Wrong or disturbed power supply line Replace electronic														
	EH2	Power supply voltage too high	Wrong or disturbed power supply line Replace electronic														
	EH3	Power supply voltage too low	Wrong or disturbed power supply line Replace electronic														
EHF	EHE	Line Safe relay faulty	Replace electronic														
	EHF	Line Safe "sensing" faulty	Replace electronic														

Service Program

Fault indication by start / pause LED

Composition alarm codes		
Alarm state		Reactivate the machine with
0	Program cycle interrupted	S Start Button
1	Program cycle interrupted Door locked	A Off / On
2	Program cycle stopped Drain pump is activated	
3	Heating step is skipped	
4	Program canceled	
5	DSP-function is skipped	
6	after 5 attempt	

Service Program

Rapid reading of alarm codes

The last alarm code can be displayed even if the programme selector is not in the 10th position (service test mode) or if the appliance is in normal operating mode (e.g. during the execution of an washing programme):

- Keep buttons 4 and 3 pressed in together.
- The alarm sequence continues as long as the two buttons are held down
- While the alarms are displayed, the appliance continues to perform the cycle or, if in the programme selection phase, maintains the previously-selected options in memory.

Indication of error code through LEDs

The error code is additionally indicated by the START/PAUSE LED.

The START/PAUSE LED is a double LED with colors red and green.

When the red LED is flashing (0.5 sec on, 0.5 sec off), the alarm family will be indicated, when the green LED is flashing afterwards, the alarm number will be indicated.

e.g. EA4

- **EA4** ----> red LED flashes 10 x
- pause of 1.5 sec
- **EA4** ----> green LED flashes 4 x
- pause of 2.5 sec, then repetition



Alarm codes	flashing
1	1 x
:	:
9	9 x
A	10 x
B	11 x
:	:
H	17 x

Cancelling the last alarm

- Enter service test program (page 30)
- Press buttons 4 and 3 in together and keep them pressed in until the LCD E00.

It is good practice to cancel the last alarm:

- after reading the alarm code, to check whether the alarm re-occurs during diagnostics
- after repairing the appliance, to check whether it re-occurs during testing.

Demo-Programm

Activate the demo - program

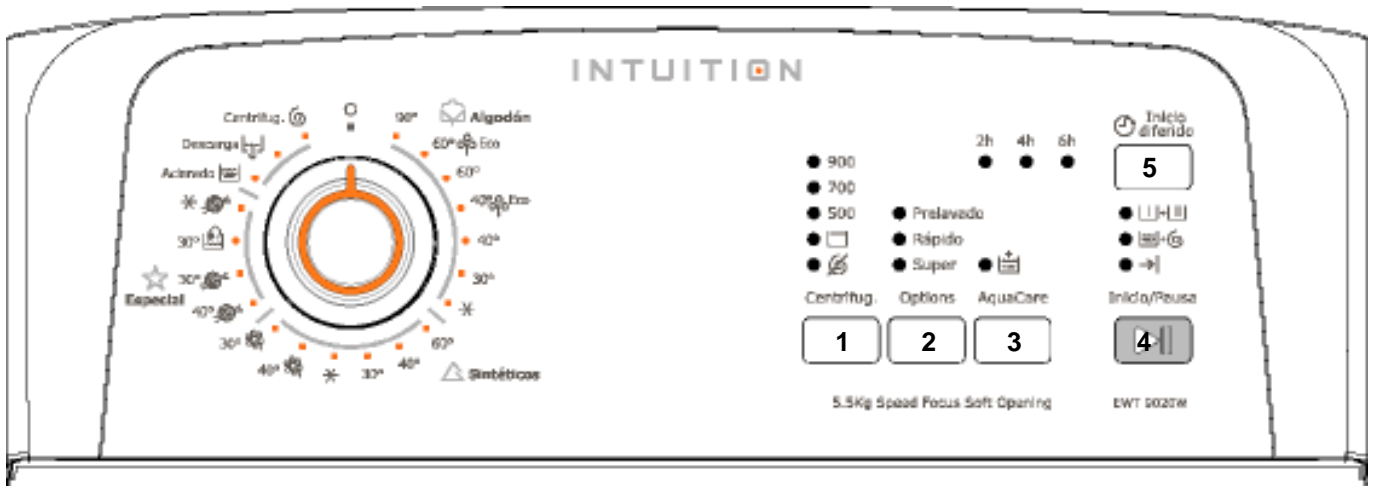

These appliances have a Demo-Mode for demonstration purposes.

main electronic EWM1100

Software **WAC101..**

1. Access to demo program

- Switch off the appliance.
- Keep buttons 4 and 3 pressed in together and rotate the programme selector three positions to the right.
- Keep both selected keys pressed for about 2 seconds.
- You can select the individual programs and the associated option keys by using the program selector switch.
The key start/pause is disabled.
- The demo program will remain in the memory even if the appliance is switched Off.

2. Adandoning the demo program

- Switch off the appliance.
- Keep buttons 4 and 3 pressed in together and rotate the programme selector three positions to the right.
- Keep both selected keys pressed for about 2 seconds.
- Switch Off the appliance to deactivate the demo program.

Electronic-Test

Activate the electronic-test

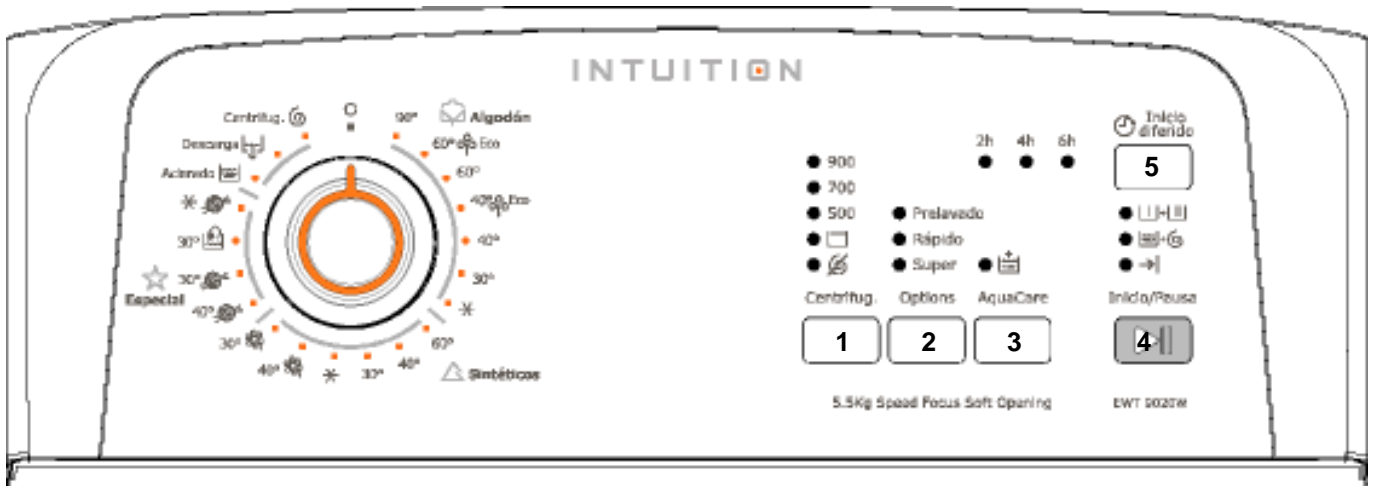

1. Access to the electronic-test

- Switch off the appliance.
- Hold buttons 4 and 3 pressed simultaneously and turn the program selector one position to the right.
- Keep both selected keys pressed for about 2 seconds.
- Hold buttons 4 and 3 together and pressed again.
- Switch off and on the appliance
- The electronic-test is running
 - Filling till 1. Niveau
 - Movement with 50 1/min.
 - Heating up to max. 50°C or 20min duration.

2. Abandoning the elektronik-test

- Switch off the appliance.

Circuit Diagram

Technical Specifications

GENERAL FEATURES

Supply voltage 230 V
Dimensions (height, width, depth) 85/40/60 cm
Dryclothes loading capacity 5,5 kg
Drum rotation speed (washing/spinning) 55/600-1500 r.p.m
Intermediate speed 1000 r.p.m
Intermediate speed 850 r.p.m

WATER LOAD CAPACITY (without clothes) :

Heating Level I 2 l
Heating Level II 2 l
Anti-overflow level 43 l

WATER PRESSURE :

Max./Min. 0,8/0,05 MPa

CONSUMPTIONS (COTTON 60°) :

see energie label

TECHNICAL PARTICULARS

DRAIN PUMP :

Maxi head 100 cm
Mini head 70 cm
Delivery rate 25 l/min
Power absorbed 30 W
Winding resistance 164/224 ohm

HEATING ELEMENT :

Power absorbed 1950 W
Resistance 27 ohm

WATER VALVE :

Delivery rate 5,5 l/min
Coil resistance 4300 ohm

CYCLING PUMP :

Delivery rate 12 l/min
Power absorbed 18 W
Winding resistance 200 ohm

DOOR INTERLOCK :

Type voltmetric
Internal door locking 0,02 s
Internal door release 0,02 s

DOOR INTERLOCK :

Type voltmetric
Internal door locking 6 s
Internal door release 40-120 s

WATERSAFETY SYSTEM :

Type 110539011

TEMPERATURE PROBE (NTC) 6 kohm at 20°C

PRESSURE SWITCH ANALOGIC :

Analogic Level 000 mm - 44,7 Hz
Analogic Level 300 mm - 36,1 Hz

USER INTERFACE : EWM1100

Identification mark 13251500.
Identification mark 13251501.
Identification mark 13251502.
Identification mark 13251503.

DOOR POSITIONNING (electric):

Identification mark 146132000

CONNECTION :

Water supply connection 1,5 m long
Water discharge connection height mini 70 / maxi 100 cm
Total power 2300 W

COLLECTOR MOTOR :

Pulley ratio 10,2
 Insulation class F
 Spinning speed 1450 r.p.m
 Winding resistance (1-2) 5,44 ohm
 Winding resistance (3-2) 5,44 ohm
 Winding resistance (1-3) 5,44 ohm

TACHOGENERATOR:

Resistance (5-4) 115 ohm

Pulley ratio 10,4
 Insulation class B/F
 Spinning speed 1450 r.p.m
 Winding resistance (3-4) 2,20 ohm
 Winding resistance (1-2-5) 0,55 ohm
 Winding resistance (2-5) 1,10 ohm

TACHOGENERATOR:

Resistance (6-7) 135 ohm

Pulley ratio 10,4
 Insulation class B/F
 Spinning speed 1450 r.p.m
 Winding resistance (3-4) 1,78 ohm
 Winding resistance (1-2-5) 0,60 ohm
 Winding resistance (2-5) 1,75 ohm

TACHOGENERATOR:

Resistance (6-7) 68,7 ohm

Pulley ratio 12
 Insulation class B/F
 Spinning speed 1250 r.p.m
 Winding resistance (3-4) 1,73 ohm
 Winding resistance (1-2-5) 1,10 ohm
 Winding resistance (2-5) 1,70 ohm

TACHOGENERATOR:

Resistance (6-7) 15,1 ohm

Pulley ratio 12
 Insulation class B/F
 Spinning speed 1250 r.p.m
 Winding resistance (3-4) 1,65 ohm
 Winding resistance (1-2-5) 0,62 ohm
 Winding resistance (2-5) 1,23 ohm

TACHOGENERATOR:

Resistance (6-7) 135 ohm

Pulley ratio 12
 Insulation class B/F
 Spinning speed 1150 r.p.m
 Winding resistance (3-4) 1,90 ohm
 Winding resistance (2-5) 1,30 ohm

TACHOGENERATOR:

Resistance (6-7) 68,7 ohm

Pulley ratio 14
 Insulation class B/F
 Spinning speed 1050 r.p.m
 Winding resistance (3-4) 1,62 ohm
 Winding resistance (2-5) 1,67 ohm

TACHOGENERATOR:

Resistance (6-7) 15,1 ohm

Pulley ratio 14
 Insulation class B/F
 Spinning speed 1050 r.p.m
 Winding resistance (3-4) 2,46 ohm
 Winding resistance (2-5) 1,86 ohm

TACHOGENERATOR:

Resistance (6-7) 68,7 ohm

Pulley ratio 18
 Insulation class B/F
 Spinning speed 850 r.p.m
 Winding resistance (3-4) 1,62 ohm
 Winding resistance (2-5) 1,67 ohm

TACHOGENERATOR:

Resistance (6-7) 15,1 ohm

Pulley ratio 18
 Insulation class B/F
 Spinning speed 850 r.p.m
 Winding resistance (3-4) 2,25 ohm
 Winding resistance (2-5) 1,83 ohm

TACHOGENERATOR:

Resistance (6-7) 68,7 ohm

Pulley ratio 21
 Insulation class B/F
 Spinning speed 600 r.p.m
 Winding resistance (3-4) 3,82 ohm
 Winding resistance (2-5) 3,58 ohm

TACHOGENERATOR:

Resistance (6-7) 68,7 ohm

Circuit Diagram

Wiring Diagram

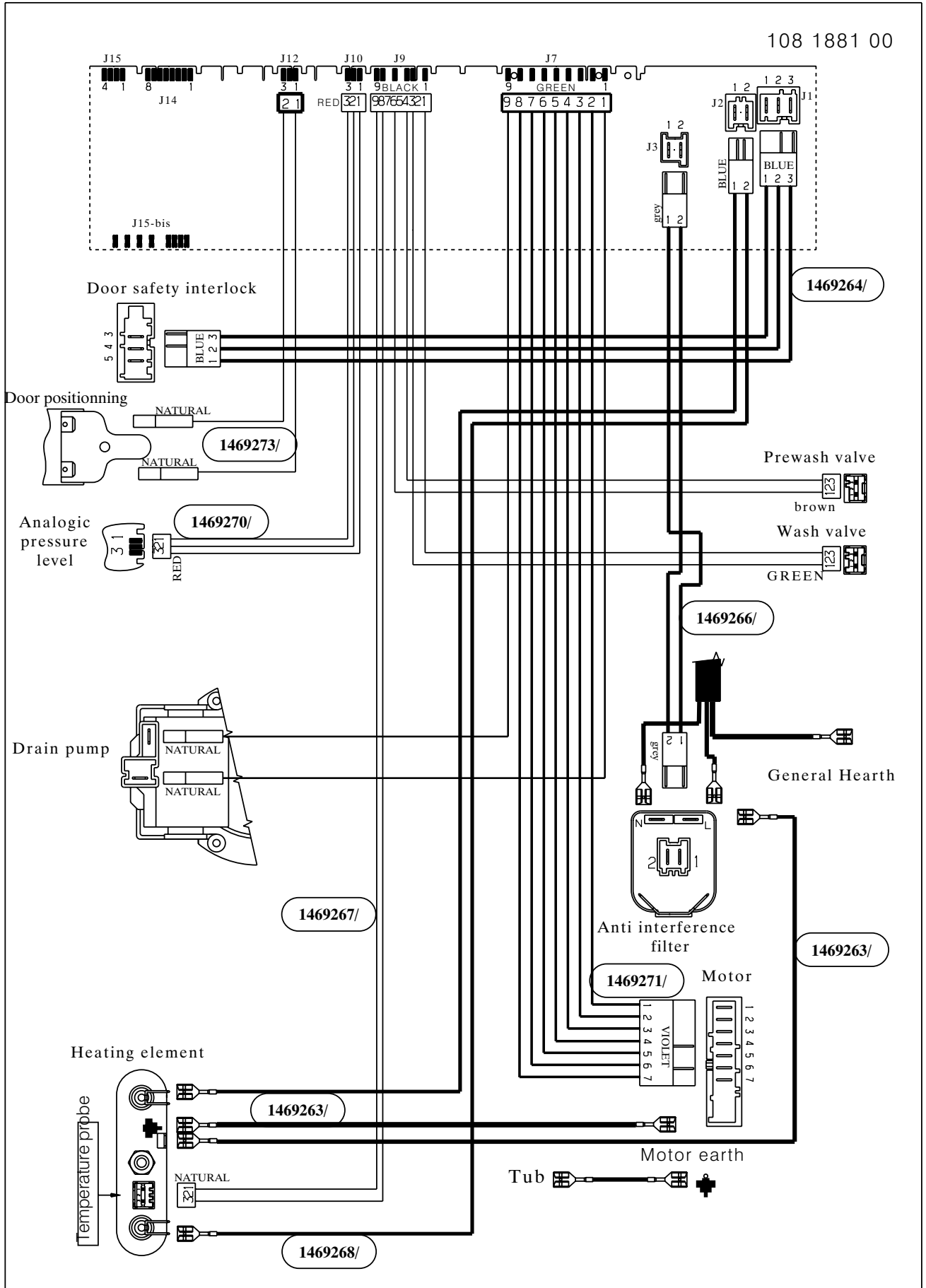

Circuit Diagram

Elementary Diagram

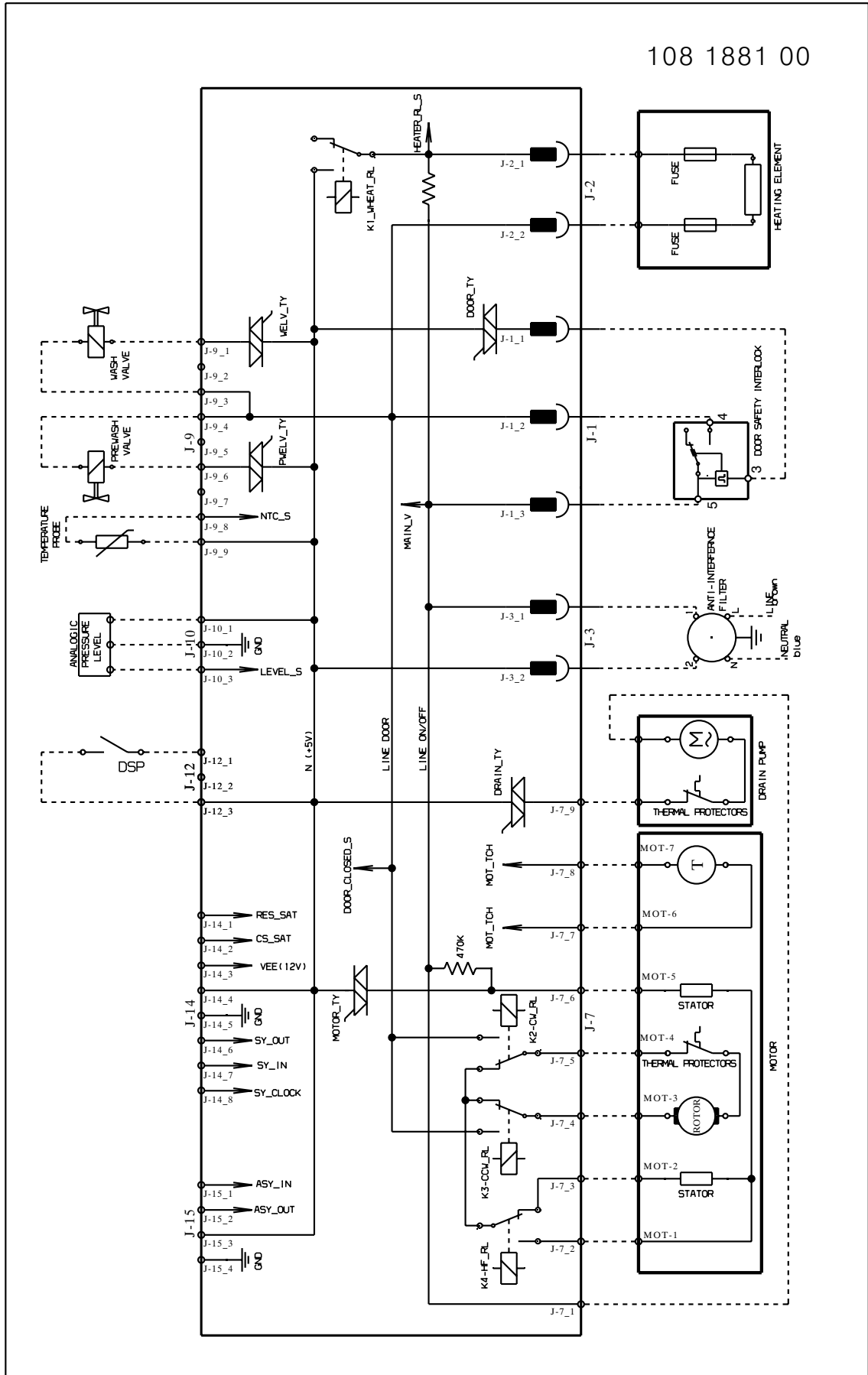

Program cycles

Cotton / Coloured 60° ECO (without options) Software WAC101..

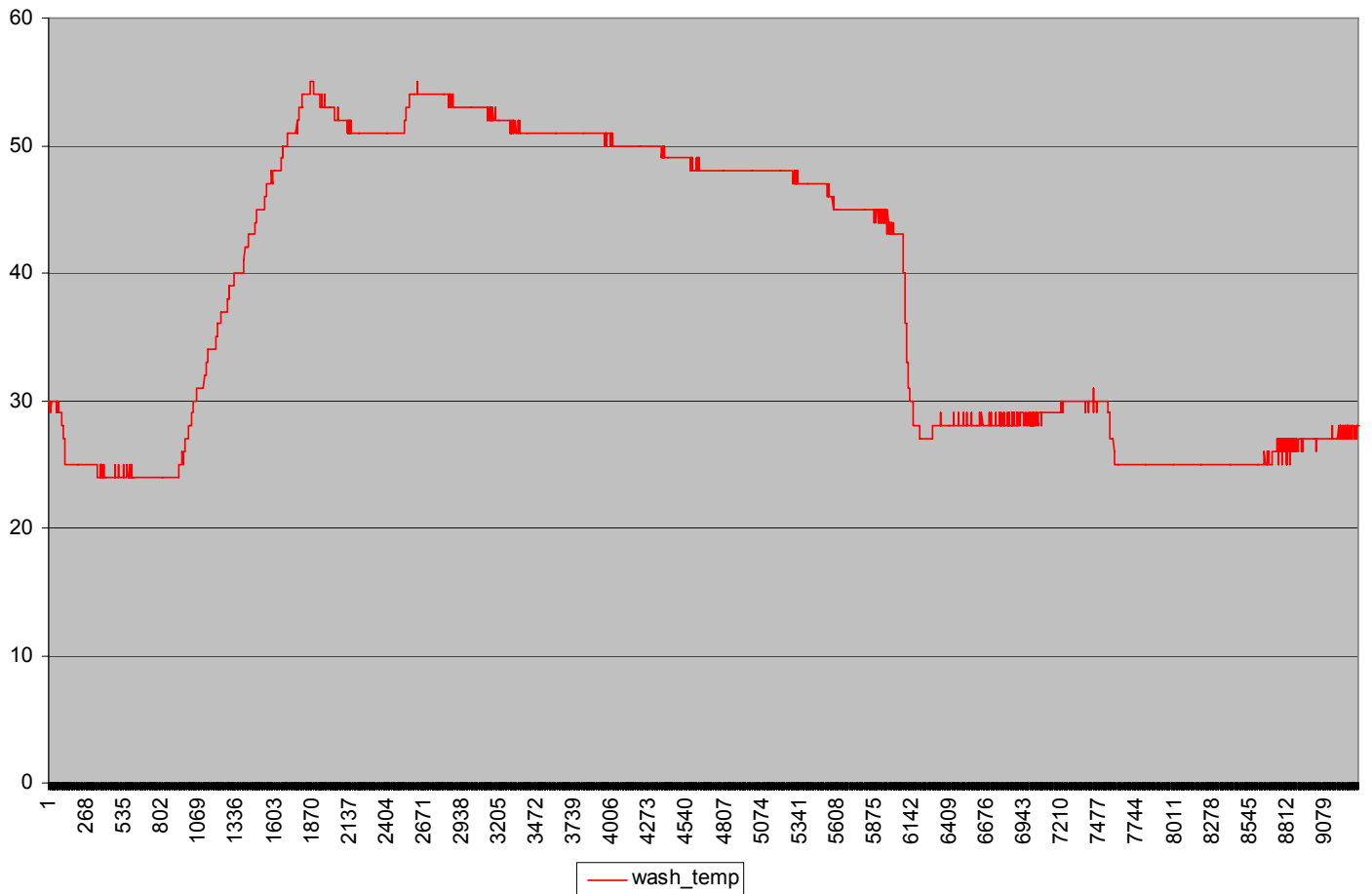
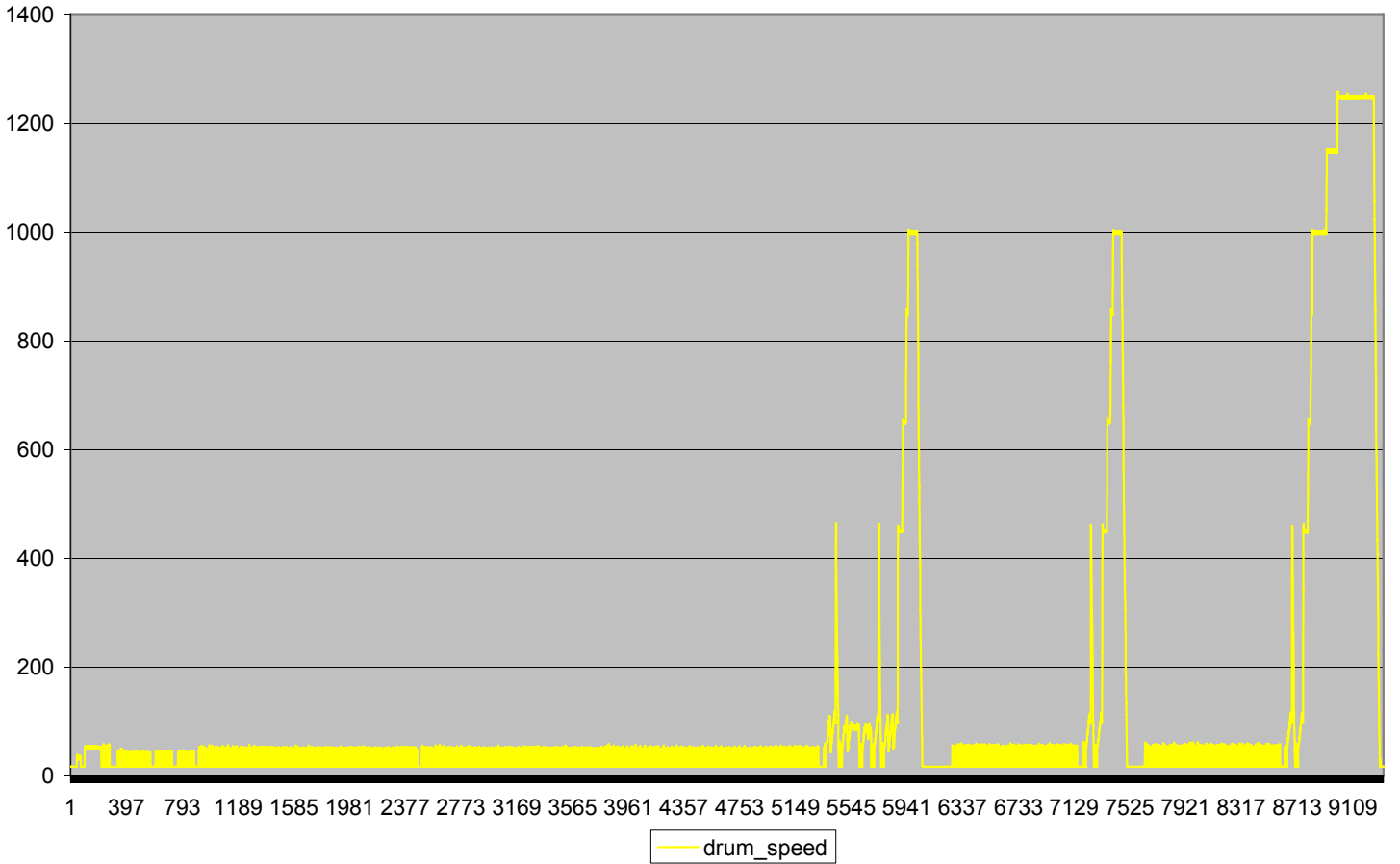

Program cycles

Cotton 60° (without options) Software WAC101..

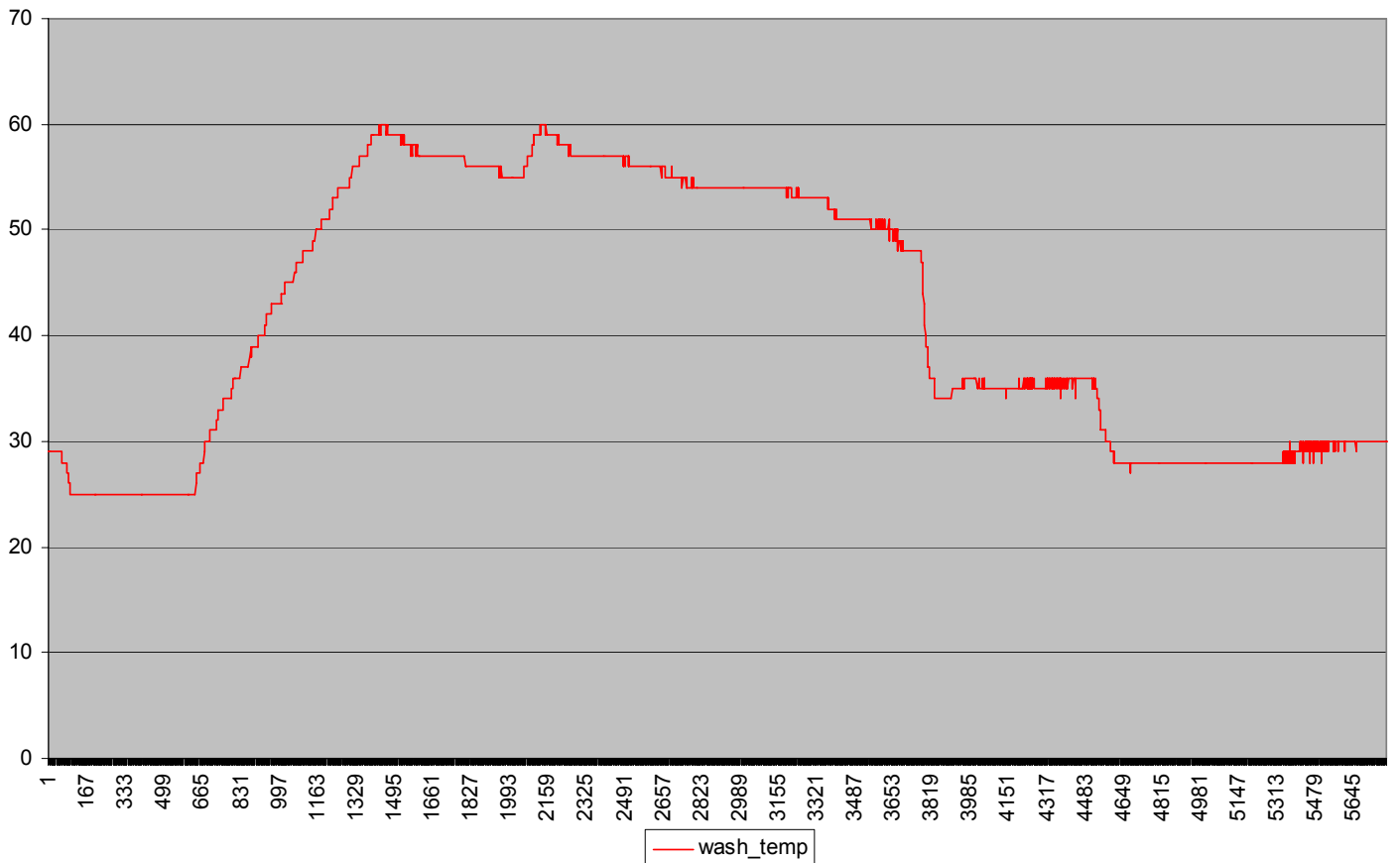
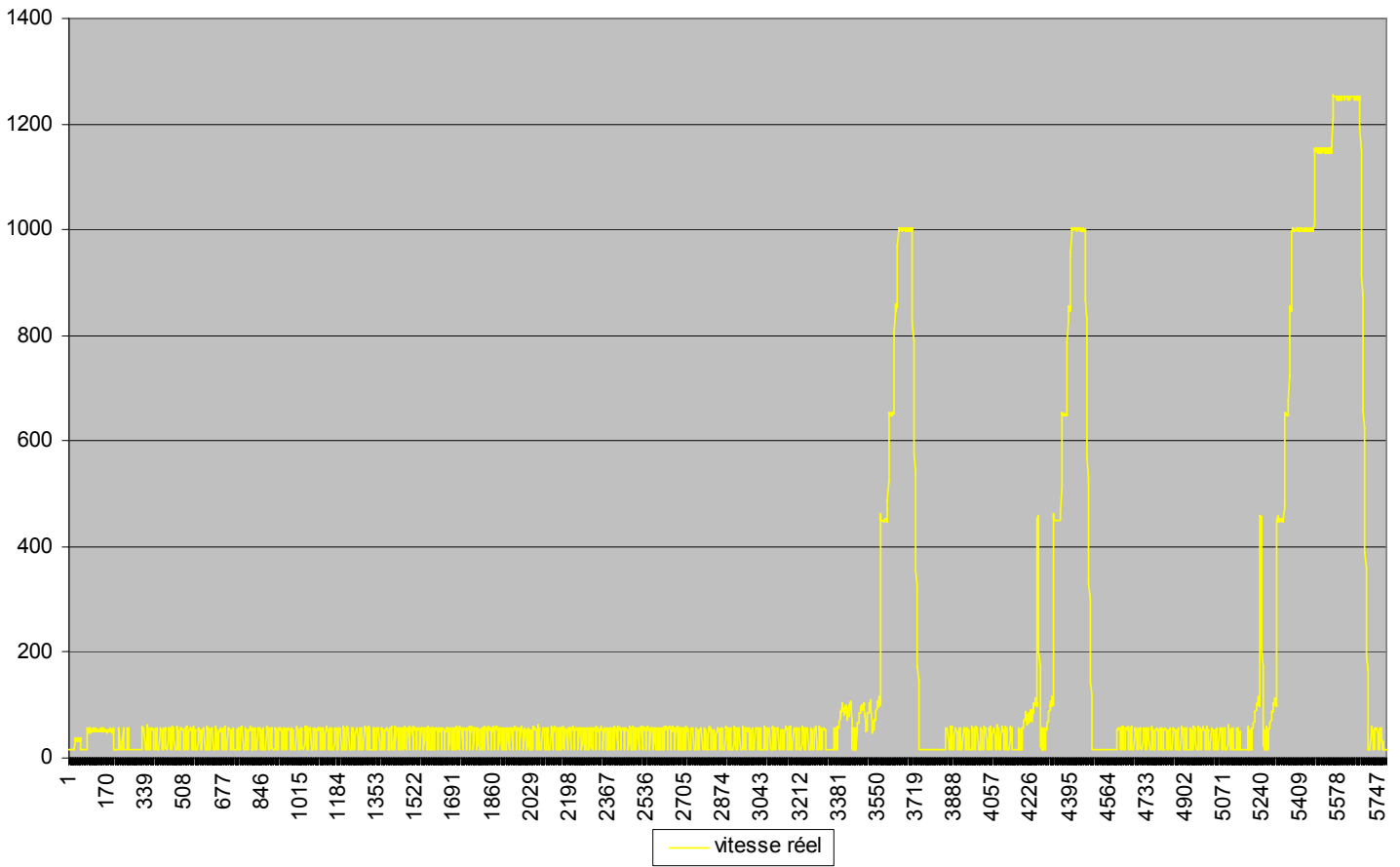

Program cycles

Cotton / Cloured 60° + Rinse+ Software WAC101..

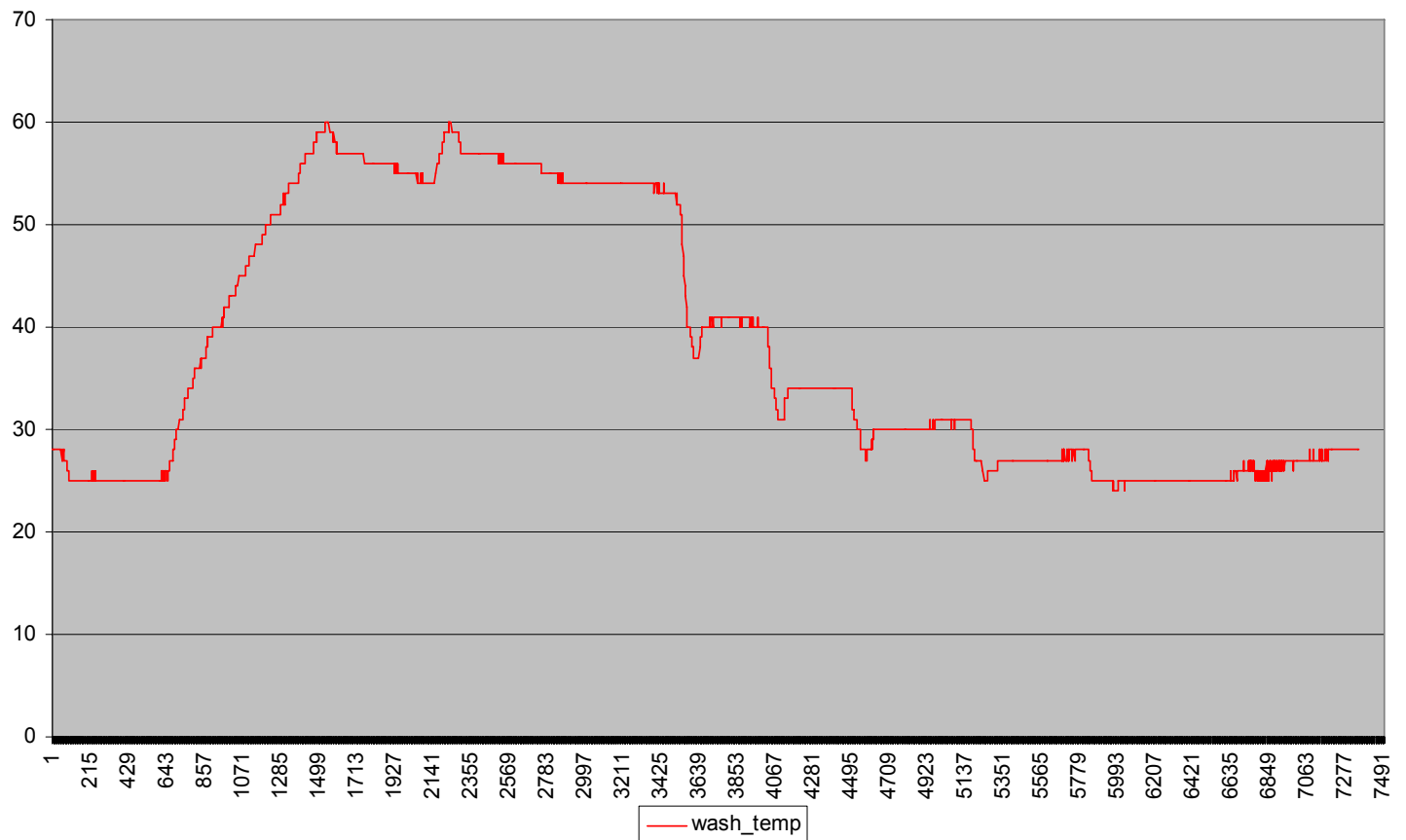
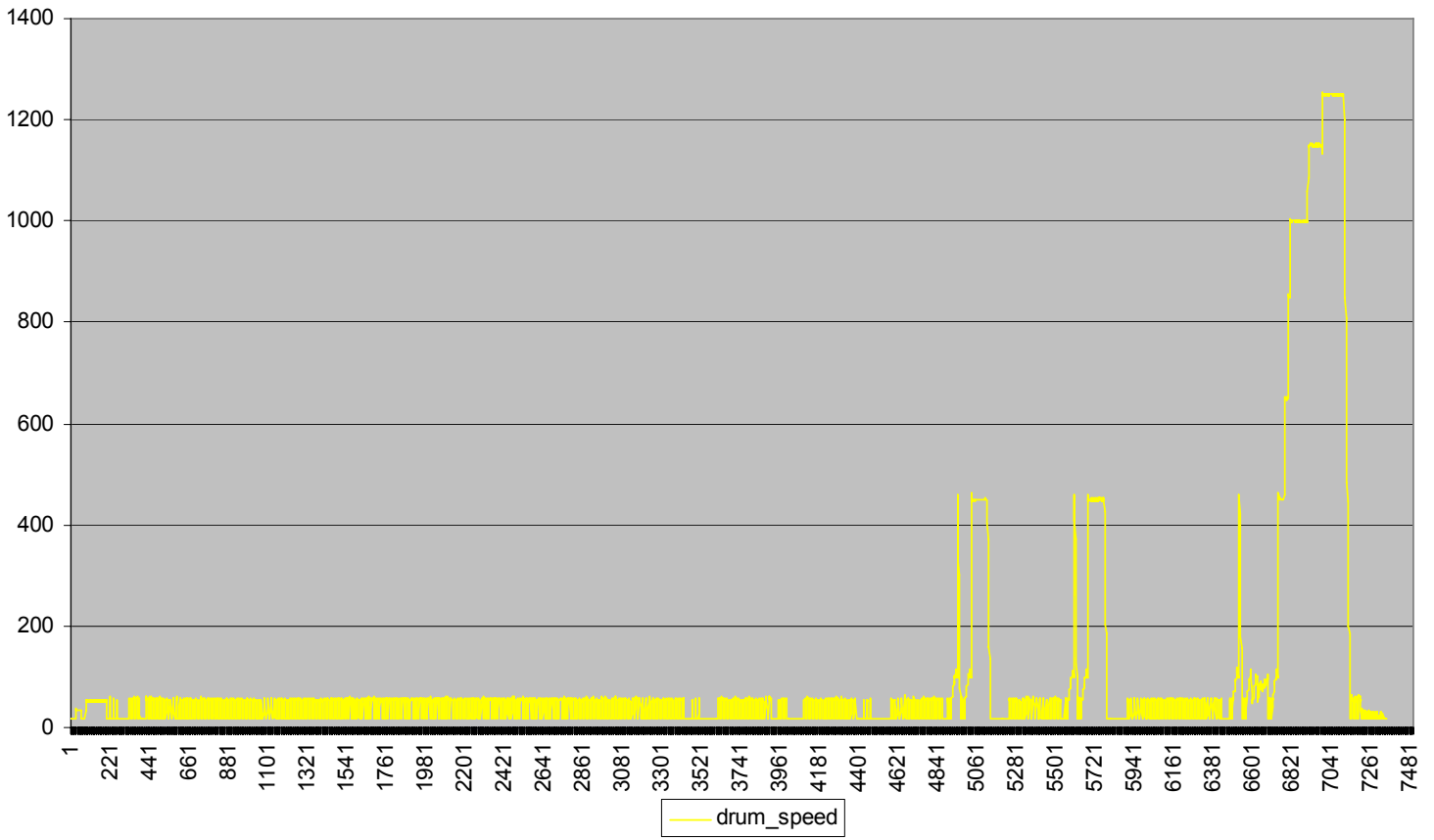

Program cycles

Cotton / coloured 60° ECO + Night cycle Software WAC101..

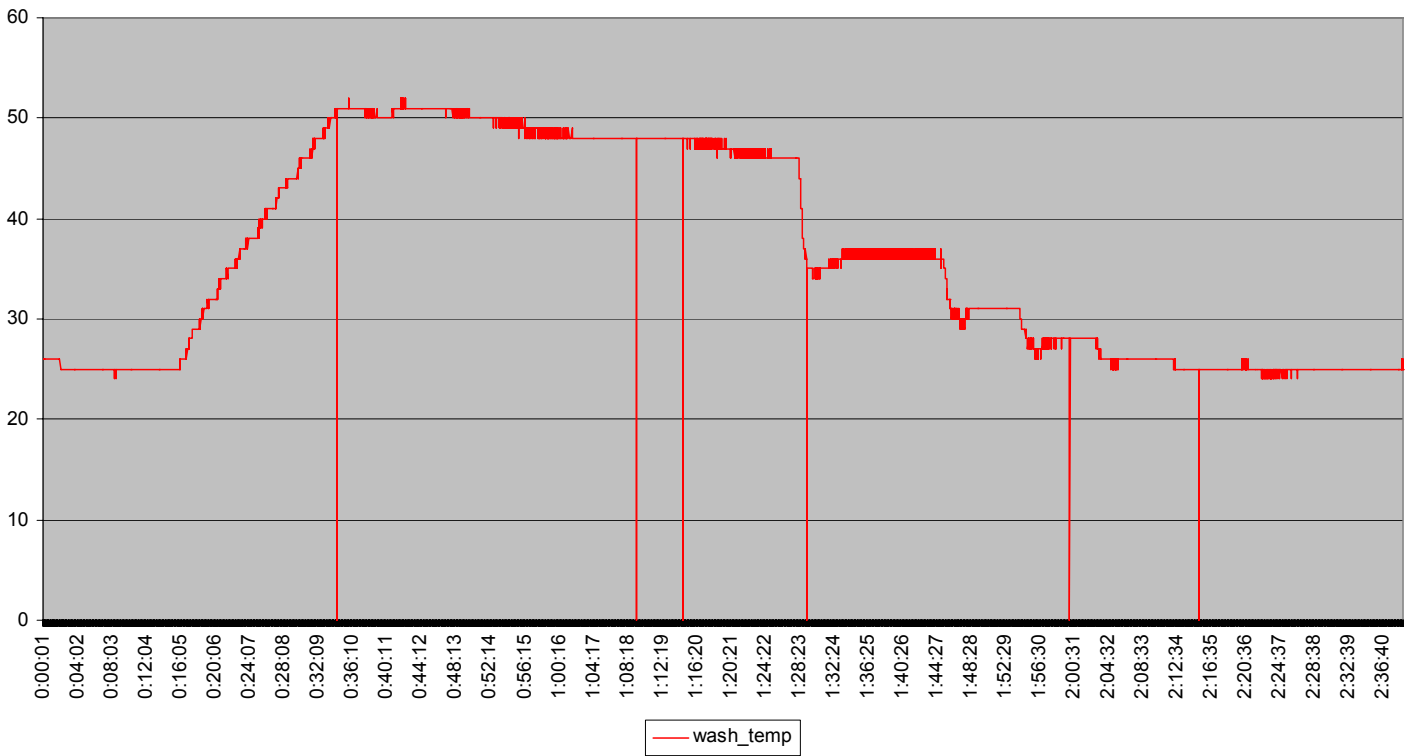
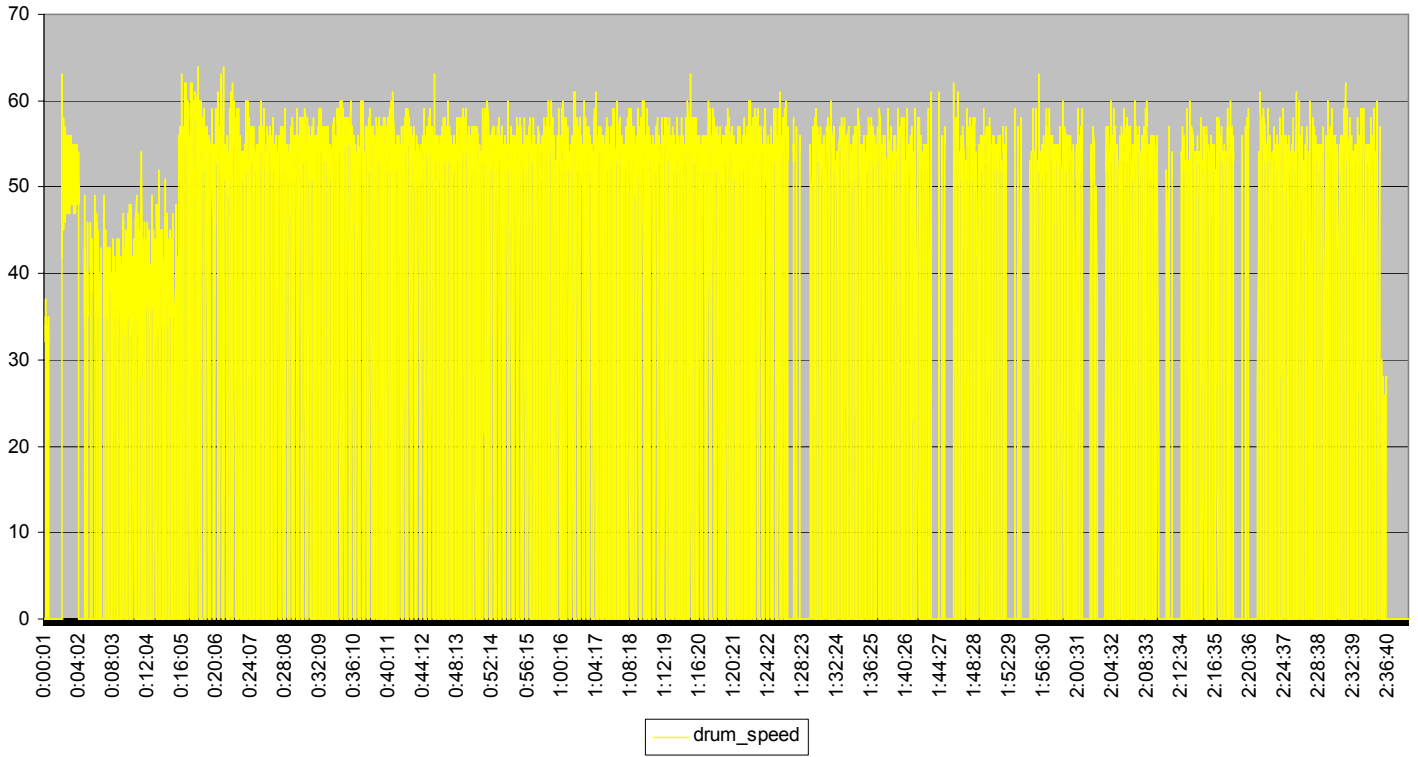

Program cycles

Synthetic 60° (without options) Software WAC101..

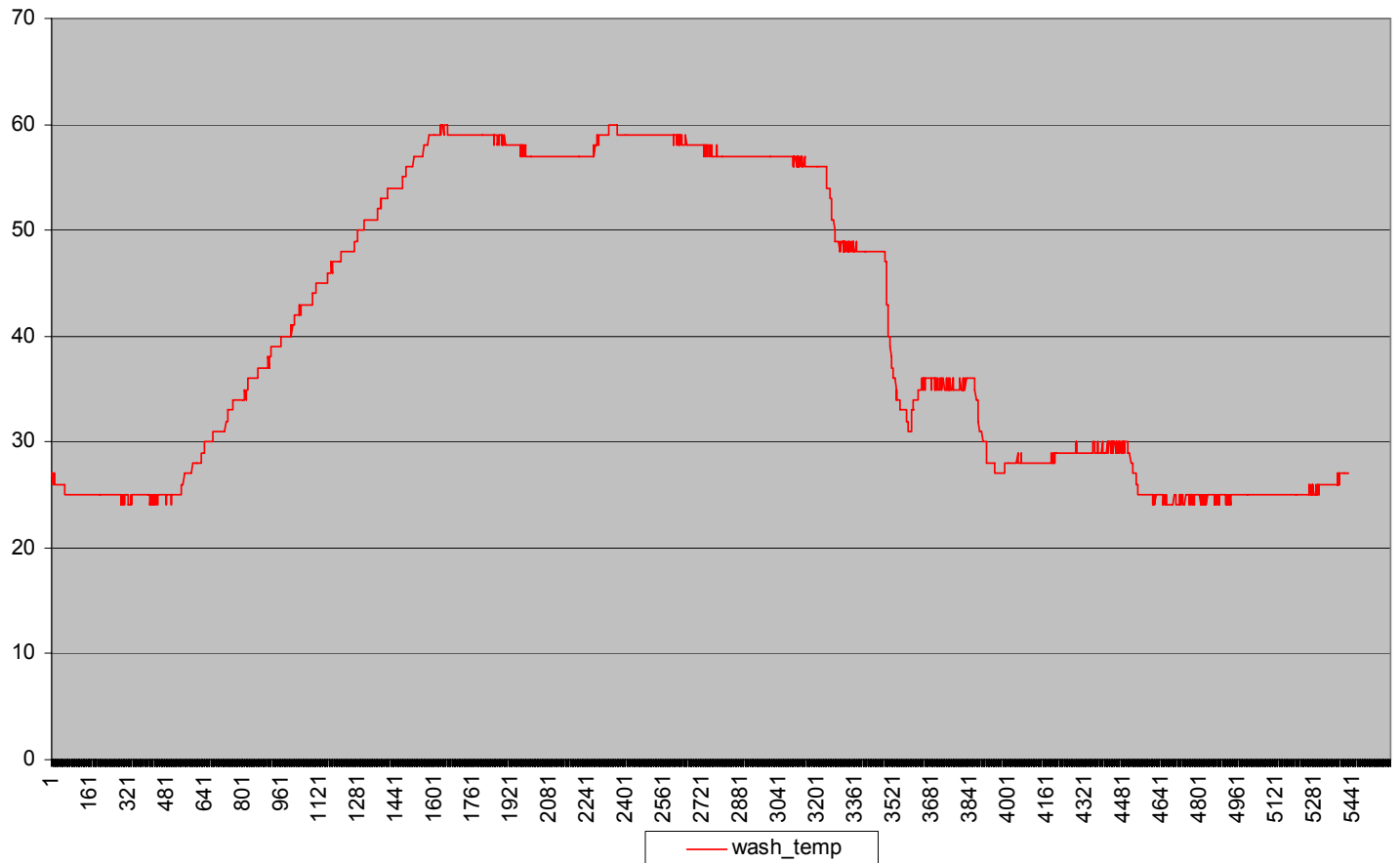
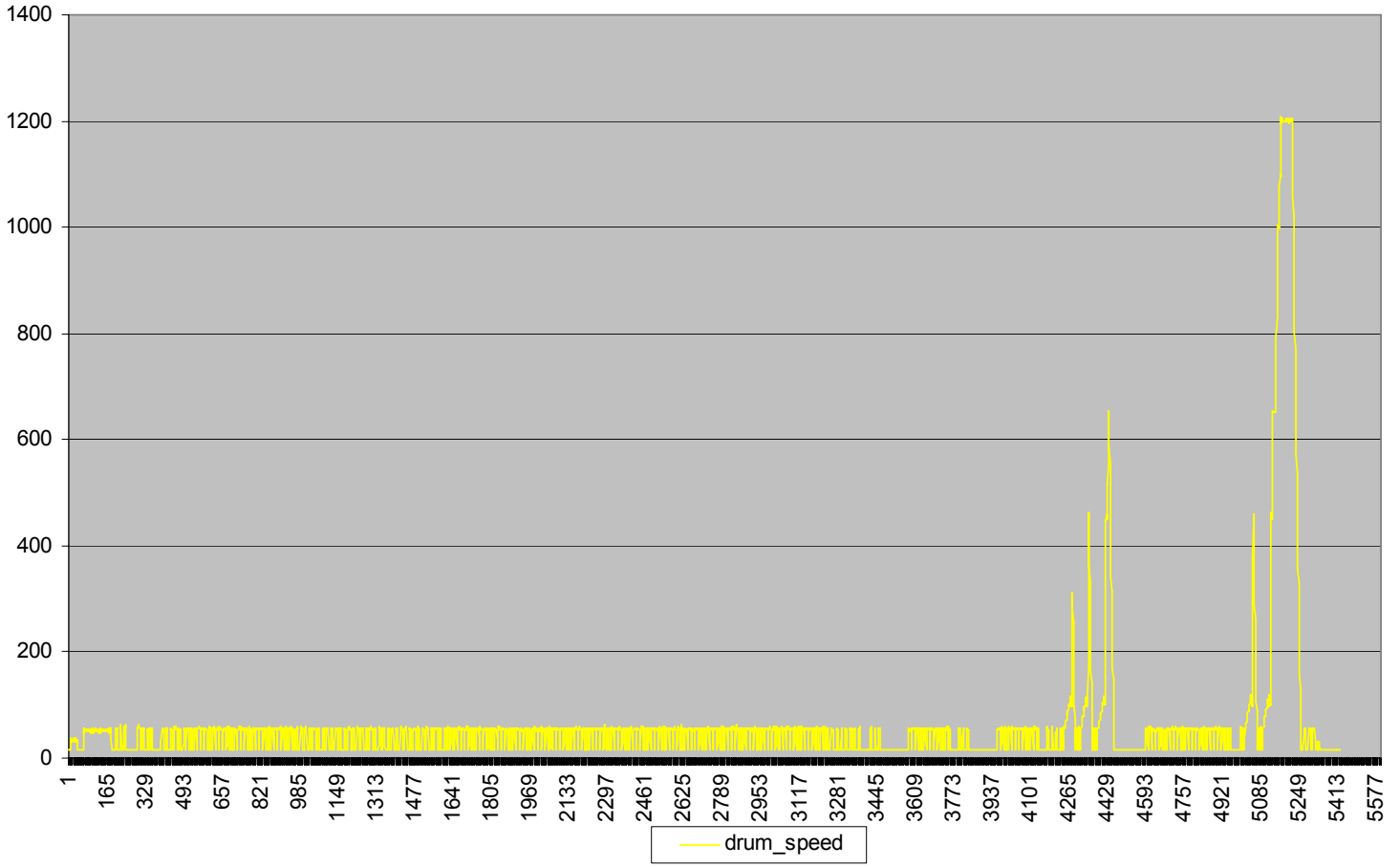

Program cycles

Delicates 40° (without options) Software WAC101..

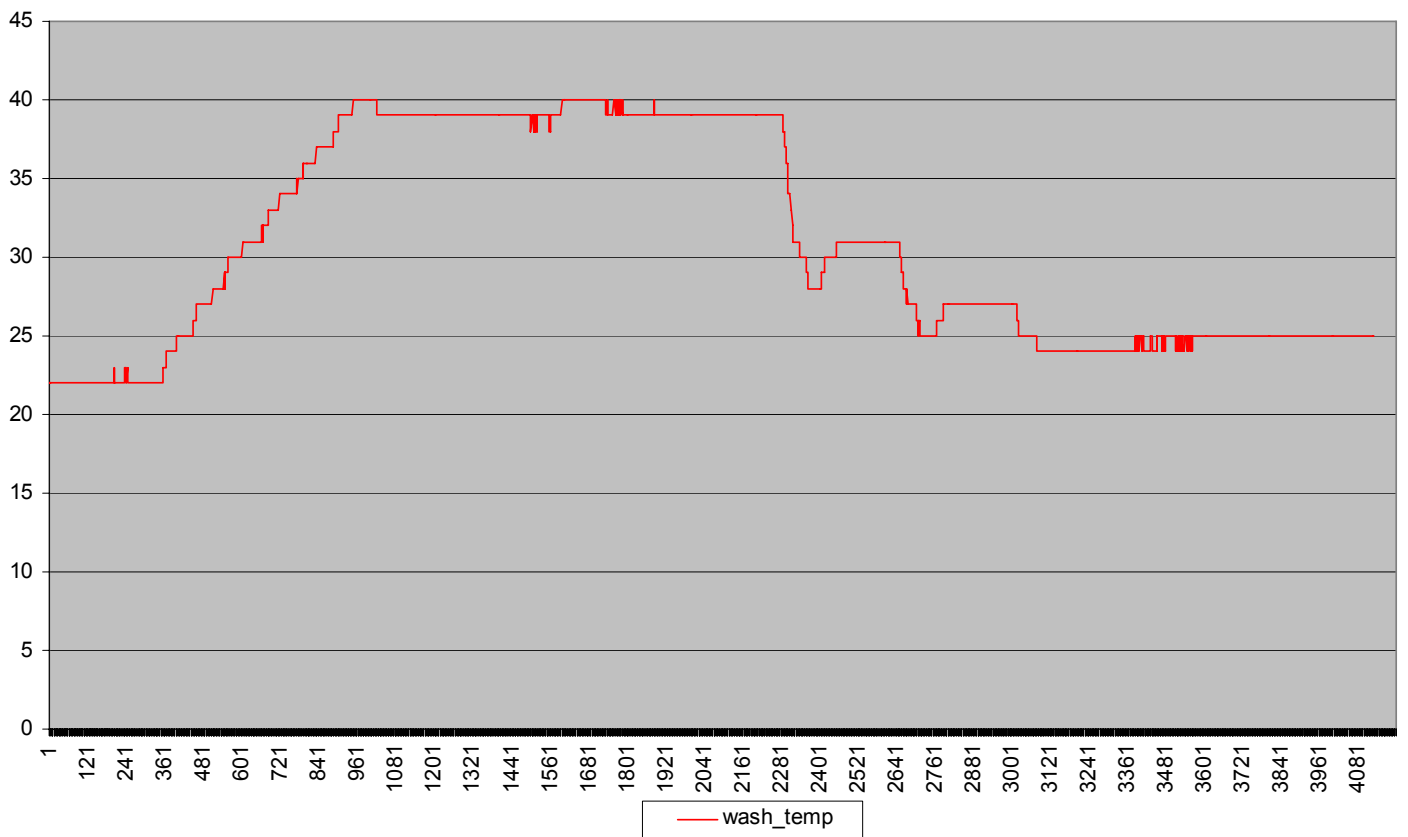
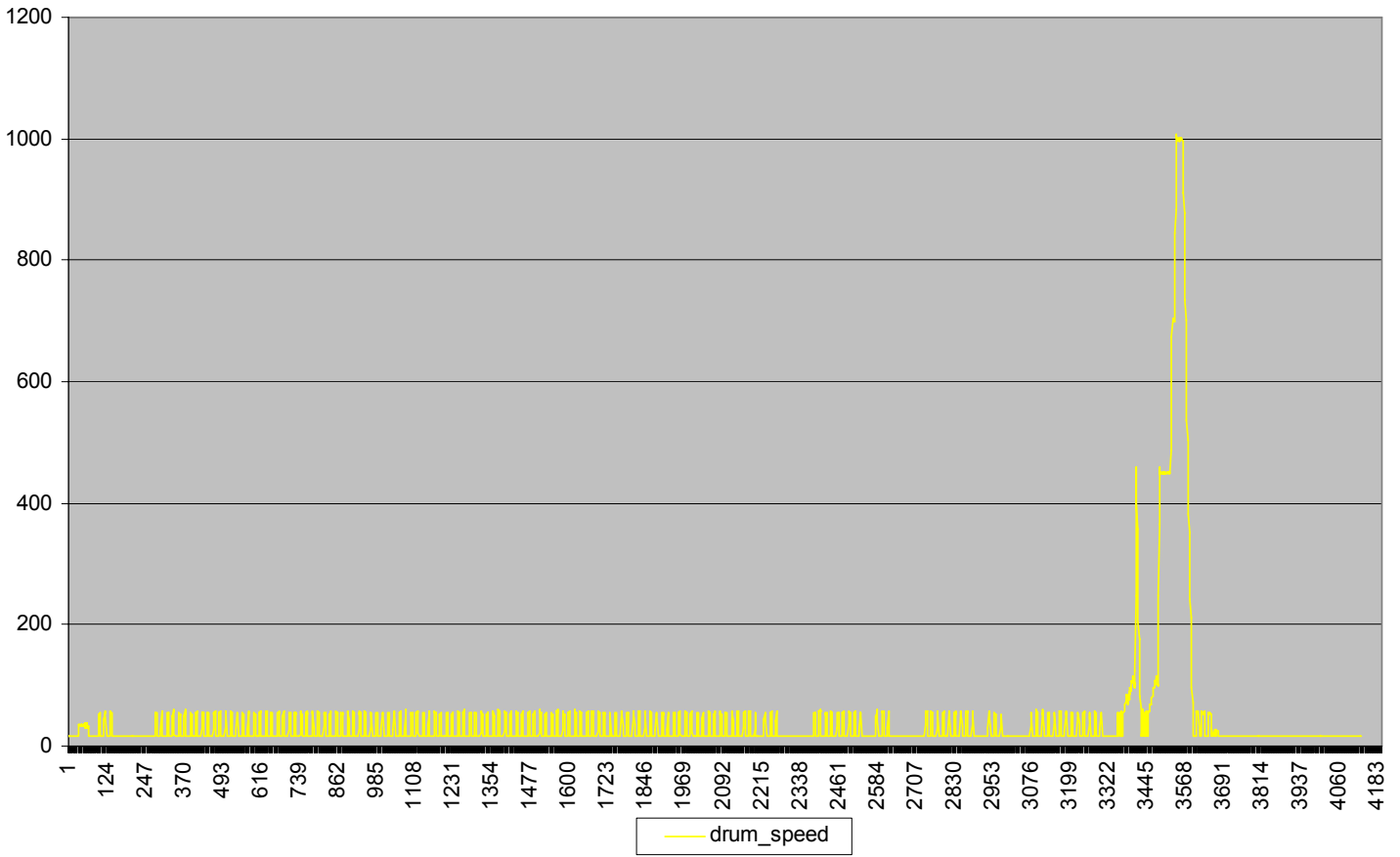

Program cycles

Wool 40° (without options)

Software WAC101..

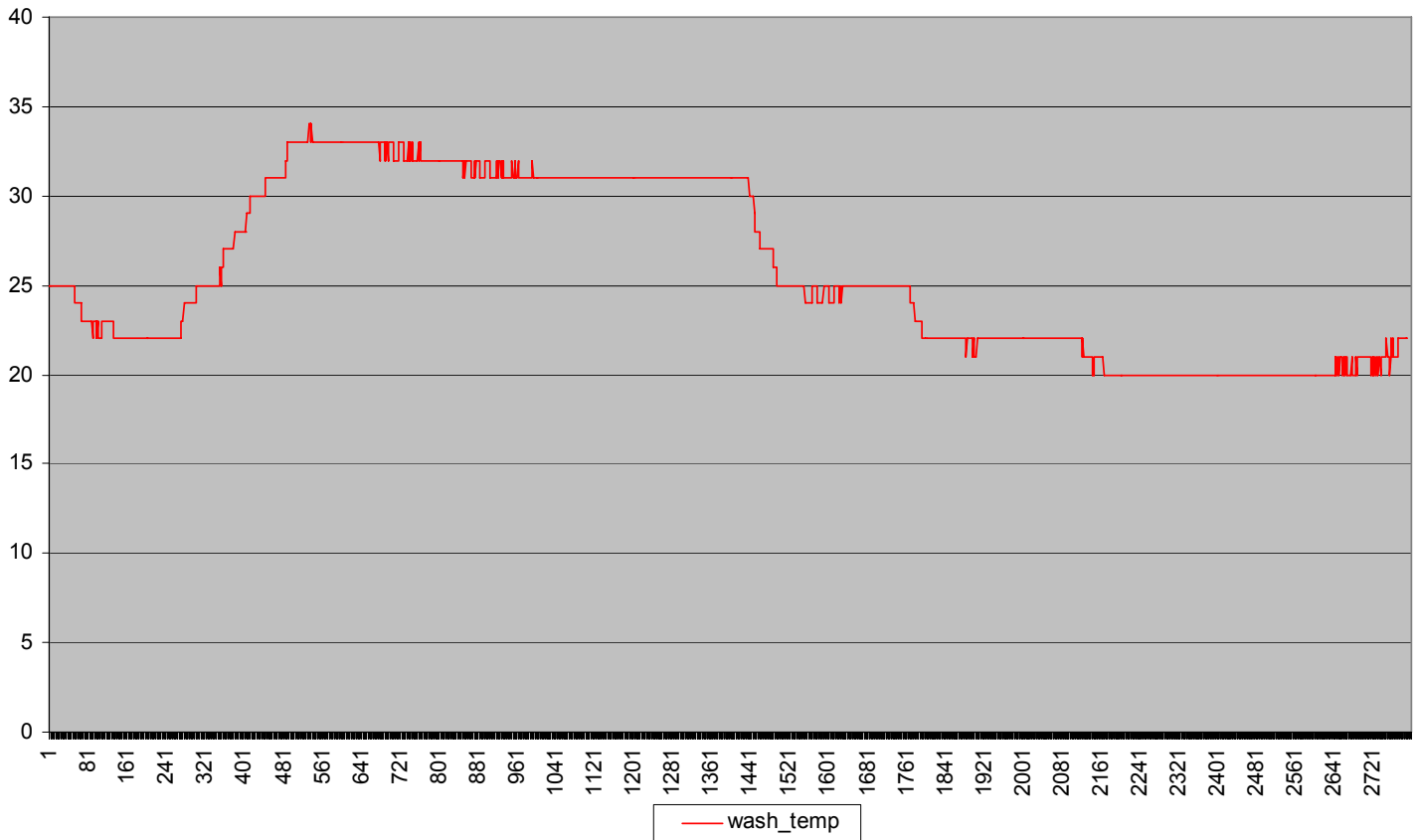
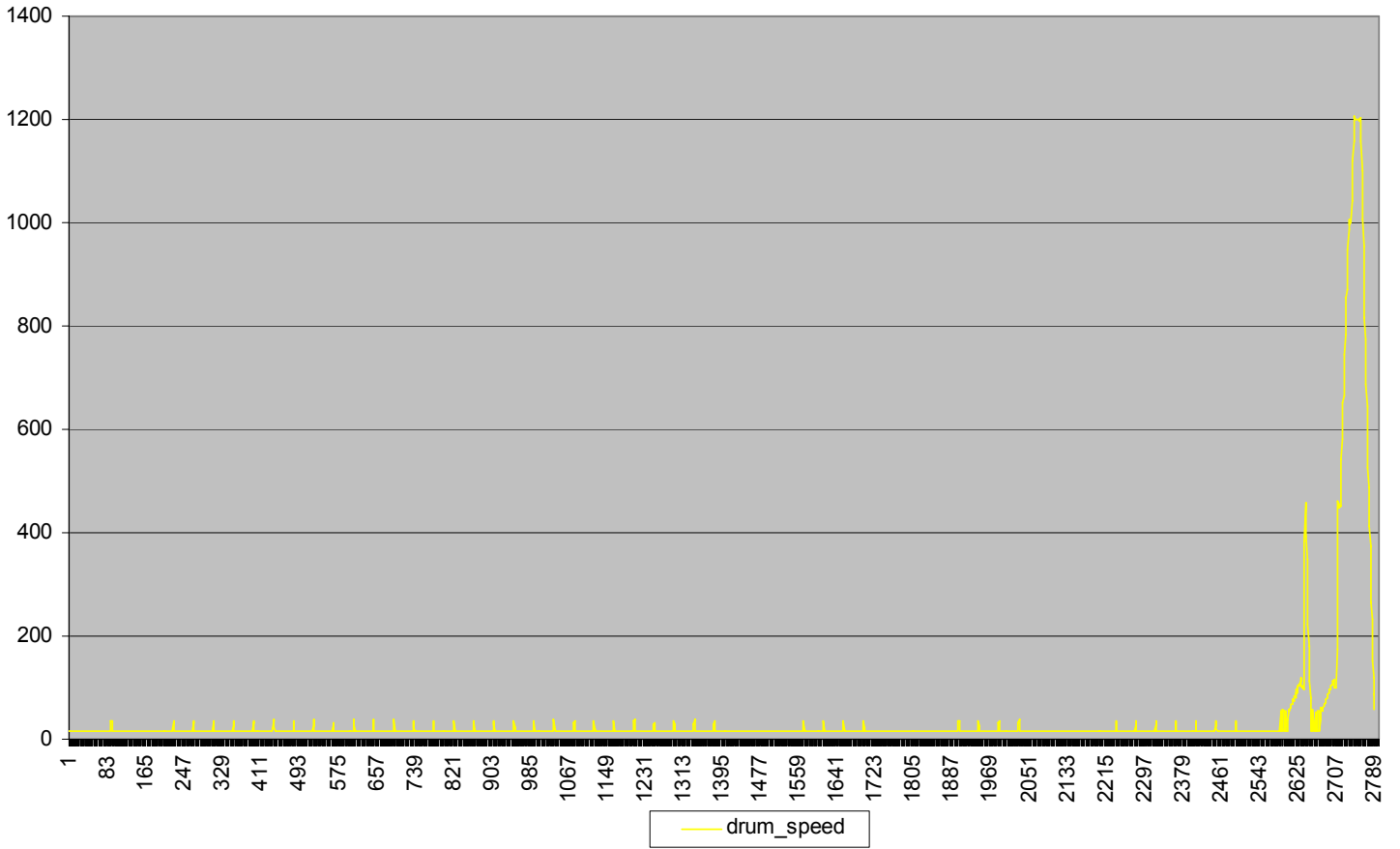

Changes

Date	Page changed
18.12.2006	4,5,8,11,14,17,21