



© ELECTROLUX ZANUSSI S.p.A.
Spares Operations Italy
Corso Lino Zanussi, 30
I - 33080 PORCIA /PN (ITALY)

Fax +39 0434 394096

Edition: 2007-03-06

Publication no.

599 38 67-66

EN

**Washing machines with
electronic control system
EWM1100**

**Technical and functional
characteristics**

ENV06

Styling

AF1 & AF2

Contents

1	Purpose of this manual	4
2	PRECAUTIONS	4
3	GENERAL CHARACTERISTICS	5
4	CONTROL PANEL	6
4.1	AF1 Styling	6
4.2	AF2 Styling	6
4.3	Configuration of control panel	7
4.3.1	Programme selector (S1)	7
4.3.2	Secondary selector (S2) if featured	7
4.4	Pushbuttons and LEDs	8
5	WASHING PROGRAMMES AND OPTIONS	10
5.1	Programmes	10
5.2	Options	11
5.2.1	Compatibility between Options	13
5.3	Description of options	14
5.3.1	No spin	15
5.3.2	Temperature adjustment	15
5.3.3	Modifying the spin speed	16
5.4	Modification of rinses on the basis of the options	17
6	TECHNICAL CHARACTERISTICS	18
6.1	Control system memory	18
6.1.1	General structure of the memory system	18
6.1.2	FLASH	18
6.1.3	RAM	19
6.2	Door interlock	20
6.2.1	Operating principle	20
6.3	Water drain system	20
6.4	Analogue pressure switch of water level control in the tub	21
6.5	Detergent dispenser	22
6.5.1	“Short” detergent dispenser	22
6.5.1.1	Operating principle	23
6.5.2	“Long” detergent dispenser	24
6.5.2.1	Operating principle	25
6.6	Drain pump	26
6.7	Heating	27
6.8	Temperature sensor	27
6.9	Motor	28
6.10	Power supply to motor	28
6.11	Anti-foam control system	28
6.12	“FUCS” (Fast Unbalance Control System)	29
7	DEMO MODE	31
7.1	Exiting DEMO mode	31
8	DIAGNOSTICS SYSTEM	31
8.1	Access to diagnostics mode	31
8.2	Exiting diagnostics mode	31
8.3	Diagnostics phases	32
9	ALARMS	33
9.1	Displaying the alarms to the user	33
9.2	Reading the alarm codes	33
9.2.1	Displaying the alarm	34
9.2.2	Examples of alarm display	34
9.2.3	Operation of alarms during diagnostics	34
9.3	Rapid reading of alarm codes	35
9.4	Cancelling the last alarm	35
9.5	Table of alarm codes	36
9.6	Basic circuit diagram	39
9.7	Key to circuit diagram	40
10	ACCESSIBILITY TO THE ELECTRONIC CONTROL SYSTEM	41
10.1.1	Work top	41
10.1.2	Control panel	41

1 Purpose of this manual

The purpose of this manual is to provide service engineers who are already familiar with the repair procedures for traditional washing machines with information regarding appliances fitted with the ENV06 electronic control system and produced in Porcia (Italy).

The characteristic of the ENV06 electronic control system is to use only an electronic pressure switch to check the various water levels in the tub (with the elimination of the mechanical pressure switches: anti-overflow, anti-boiling, 1st-2nd level), and a new heater with two thermal fuses which interrupt if the temperature degree overcomes the values by which they are calibrated.

The following are described:

- general characteristics
- control panel and washing programmes
- technical and functional characteristics
- access to the electronic control system

For detailed information concerning hydraulic circuit, structural characteristics of the appliances and accessibility, please refer to Service Manual:

- *Publication no. 599 37 47-13 – washing machines with HEC cabinet.*

2 PRECAUTIONS



- **Electrical appliances must be serviced only by qualified Service Engineers.**
- **Always remove the plug from the power socket before touching internal components.**
- **In case of replacement of the heater, replace it with one with the same characteristics in order not to compromise the safety of the appliance.**

3 GENERAL CHARACTERISTICS

The ENV060 electronic control system consists of a single PCB, which incorporates the power, control and display functions. The PCB is mounted on a casing fitted to the control panel.

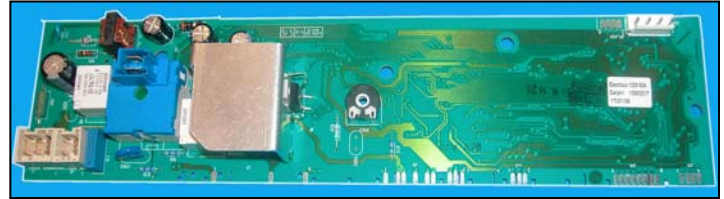

There are two basic versions of the board:

- ◆ one with the programme selector only;
- ◆ one with the programme selector and another selector that can regulate the temperature or the spin speed.

Version AF1	
Version AF2	
Number of buttons	▪ Max. 5 (4 options + start/pause)
Number of LEDs	▪ Max. 17
Programme selector	▪ 15-21 positions with main switch (incorporated in the PCB)
Secondary selector	▪ 6 positions for TC5 version only (incorporated in the PCB)
Serial port	▪ DAAS-EAP communications protocol up to 115.200 baud
Power supply	▪ 220/240V ▪ 50/60 Hz (configurable)
Type of washing	▪ Traditional ▪ With “eco-ball” sphere
Rinsing system	▪ Traditional
Motor	▪ Collector, with tachometric generator
Spin speed	▪ 600 ÷ 1600 rpm
Anti-unbalancing system	▪ FUCS
Water fill	▪ 1 solenoid valve with 1 inlet - 2 outlets
Detergent drawer	▪ 3 compartments: prewash/stains, wash, conditioners ▪ 4 compartments: prewash/stains, wash, conditioners, bleach
Control of water level in the tub	▪ Electronic/analogue pressure switch
Door safety device	▪ Traditional (with PTC)
Power of heating element	▪ 1950W with thermal fuse incorporated
Temperature control	▪ NTC sensor incorporated in the heater

4 CONTROL PANEL

4.1 AF1 Styling

- max. 5 buttons
- 15 or 21-position programme selector
- 6-position second selector
- 17 LEDs



4.2 AF2 Styling

- max. 5 buttons
- 15 or 21-position programme selector
- 17 LEDs



- Disposition of LEDs and buttons

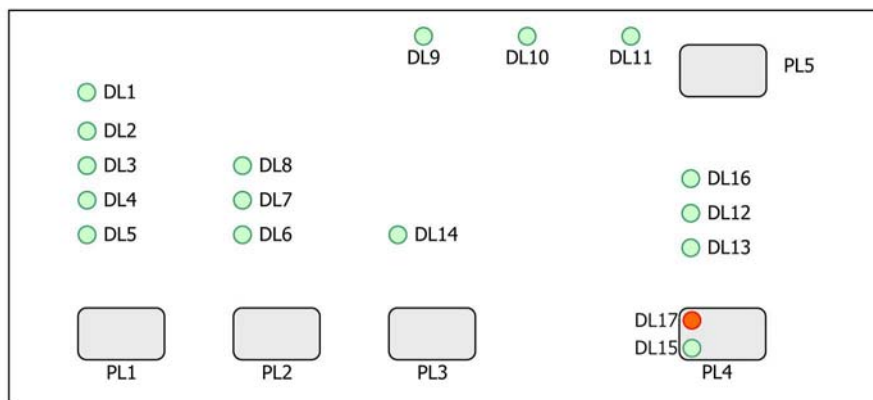

4.3 Configuration of control panel

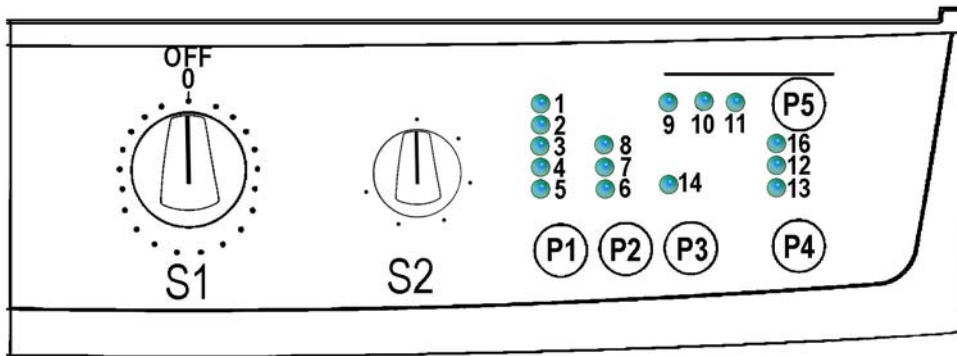

The washing programmes, the functions of the selector knob and the various pushbuttons vary according to the model, since these are determined by the configuration of the appliance.

4.3.1 Programme selector (S1)

The selector features 15-21 positions and incorporates the ON/OFF switch. The various positions of the selector may be configured to perform different washing programmes; in the first position, the appliance is switched off and the current programme is cancelled. For each programme, the compatible options and other parameters are defined.



- **Programme configuration**

The table below lists the parameters that can be used to define the washing programmes.

Types of fabric	Cotton/linen, Synthetic fabrics, Delicates, Wool, Hand-wash, Shoes, Jeans, Duvet, Silk.
Special programmes	Soak, Miniprogramme, Easy-Iron, Conditioner, Rinses, Delicate rinses, Drain, Delicate spin, Spin.
Temperature	Normal, Maximum: the initial temperature is the maximum that can be selected for a specific washing programme.
Spin	Normal, Minimum, Maximum.
Options (Normal / Possible)	Rinse Hold, Night-time cycle, Pre-wash, Stains, Bleach, Economy (energy label), Extra rinse, Half-load, Easy-Iron, Reduced spin speed, No spin, Intensive, Daily, Light, Short, Very short.
Programme phases	Pre-wash, Wash, Rinses, Spin, Delayed start.

4.3.2 Secondary selector (S2) if featured

Certain models may also feature a 6-position secondary selector. The function of this selector is defined through the configuration of the appliance.

- **Temperature selector:** each position corresponds to a temperature or to the cold wash cycle.
- **Spin speed selector:** for each position, it is possible to select a spin speed that is compatible with the programme. In the final positions, the following options can also be configured: **No Spin, Rinse Hold, Night cycle.**

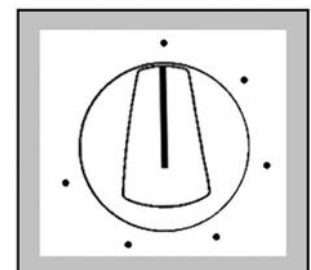

4.4 Pushbuttons and LEDs

The functions of each button are defined by the configuration of the appliance.

Version **AF1** with S2 selector configured as temperature regulator
Version **AF2**.

- **Button no. 1:** this button is connected to LEDs (L1÷L5); pressing it sequentially the spin speed varies from the max. speed, to no spin or to rinse hold.

Version **AF1**

With S2 selector configured as spin speed regulator.

- **Button no. 1:** this button is connected to LEDs (L1÷L5); pressing it sequentially the cycle temperature varies from max. to cold cycle.

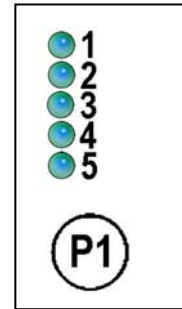

- **Button no. 2:** this button is configurable and is connected to LEDs (L6÷L8). (In some appliances it is connected to "Time driver").

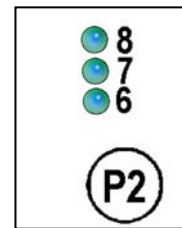

- **Button no. 3:** this button is configurable and is connected to LED (L14); it performs the super rinse function.

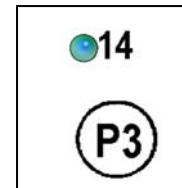

- **Button no. 4:** this button is configurable and has the function of START/PAUSE (inside it there are two LEDs, one red that flashes in case of alarm and one green that flashes when the appliance is in pause or in connection with the red one to indicate the alarm code).

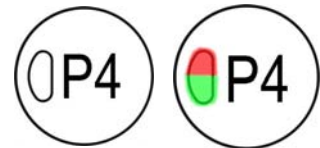

- **Button no. 5:** this button is configurable and is connected to LEDs (L9÷L11); it performs the function of delayed start, pressing it sequentially, three delay times appear with lighting of the relative LED.

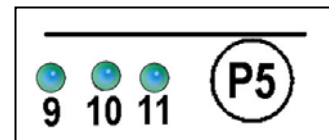

- **LED wash phase indicators:**

The LEDs L13, L12, L16 are configurable and are used as indicators of the wash phases.

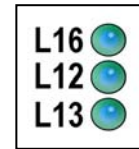

Indications	
Pre-wash	Lights during selection mode if the programme includes the pre-wash phase, and during the execution of the pre-wash
Wash	Lights during selection mode if the programme includes the wash phase, and during the execution of the wash
Pre-wash/Wash	Lights during selection mode if the programme includes the pre-wash or wash phases, and during the execution of these phases
Rinses	Lights during selection mode if the programme includes rinse phases, and during the execution of the rinses
Spin	Lights during selection mode if the programme includes the spin phase, and during the execution of the spin
Rinses / Spin	Lights during selection mode if the programme includes rinses and spin and during the execution of these phases
Drain	Lights during selection mode if the programme includes the drain phase, and during the execution of the drain
Extra rinse	Lights when this option has been memorized (if included in the cycle)
Rinse-hold	Lights if the programme includes the rinse-hold option and at the end of the cycle, when the appliance stops with water in the tub
Current cycle	Lights during execution of the cycle
End of cycle	Lights when the programme has been completed; also used to display alarm conditions
Door locked	Lights when the door lock prevents opening of the door, and switches off when the door can be opened. Flashes when the interlock is about to release the door (may be seen if PTC devices are used, as these require one or two minutes before releasing the lock)
Child lock	Lights when the child safety is on and all buttons are deactivated

5 WASHING PROGRAMMES AND OPTIONS

5.1 Programmes

The washing programmes can be configured. The basic programmes are listed in the table below.

Programme		Temperature (°C)	Number of rinses	Final spin (rpm)
Cotton	90	82	3	450/650/850/1000/1200/ 1300/1600
	90E	67	(**)	
	60	60	3	
	60E	54 (*)	(**)	
	50	50	3	
	50/40E	43 (*)	(**)	
	40	40	3	
	30	30	3	
	cold	20		
Synthetic fabrics	60	60	3	Max. 900
	60/50E	42 (*)	(**)	
	50	50	3	
	40	42		
	30	30		
	cold	20		
Mini Programme	30	30	3	Max. 900
	cold	20		
Delicates	40	40	3	450/700
	30	30		
	cold	20		
Wool Hand-wash	40	38	3	Max. 1000
	30	33		
	cold	20		
Shoes	40	40	3	Max. 1000
	30	30		
	cold	20		
Jeans	60	60	5	450/650/850/1000/1200/ 1300/1600
	50	50		
	40	40		
	30	30		
	cold	20		
Soak		30/20	----	----
Rinses		----	3	Max. 1600
Conditioner		----	1	Max. 1460
Drain		----	----	----
Spin		----	----	Max. 1600

The data are indicative.

(*) "Energy label" programmes

(**) In some countries the rinses are 3, in others 2

5.2 Options

The table below lists the possible options for the washing programmes, the compatibility of the various options and with the cycle, and when it is possible to select or modify the options.

The options can be selected in three ways:

- using the programme selector: in this case, the options are configured as special programmes;
- using the secondary selector (temperature or spin speed);
- using the pushbuttons.

		OPTIONS															
		Rinse-hold	Night cycle	Pre-wash	Stains	Bleach	Extra rinse	Easy-iron	Economy (*)	Normal	Daily	Light	Super Quick	Reduced spin speed	No spin	Half-load	
Compatibility with PROGRAMMES	Cotton	90°C	X	X	X	X	X	X	X	X	X	X	X	X	X	X	
		60°C	X	X	X	X	X	X	X	X	X	X	X	X	X	X	
		50°C	X	X	X	X	X	X	X	X	X	X	X	X	X	X	
		40°C	X	X	X	X	X	X	X	X	X	X	X	X	X	X	
		30°C	X	X	X		X	X	X		X	X	X	X	X	X	X
		cold	X	X	X		X	X	X		X	X	X	X	X	X	X
	Synthetic fabrics	60°C	X	X	X	X		X	X	X	X	X	X	X	X	X	
		50°C	X	X	X	X		X	X	X	X	X	X	X	X	X	
		40°C	X	X	X	X		X	X	X	X	X	X	X	X	X	
		30°C	X	X	X			X	X		X	X	X	X	X	X	
		cold	X	X	X			X	X		X	X	X	X	X	X	
	Delicates	40°C	X	X	X	X		X			X	X	X	X	X	X	
		30°C	X	X	X			X			X	X	X	X	X	X	
		cold	X	X	X			X			X	X	X	X	X	X	
	Wool / Hand-wash	40°C	X	X										X			
		30°C	X	X										X			
		cold	X	X										X			
	Easy-iron	60°C	X		X			X	X		X			X	X		
		50°C	X		X			X	X		X			X	X		
		40°C	X		X			X	X		X			X	X		
		30°C	X		X			X	X		X			X	X		
		cold	X		X			X	X		X			X	X		
	Duvet	40°C									X			X			
		30°C									X			X			
	Jeans	60°C	X	X	X			X	X		X			X	X		
		50°C	X	X	X			X	X		X			X	X		
		40°C	X	X	X			X	X		X			X	X		
		30°C	X	X	X			X	X		X			X	X		
		cold	X	X	X			X	X		X			X	X		
	Shoes	40°C	X	X	X			X			X			X			
		30°C	X	X	X			X			X			X			
		cold	X	X	X			X			X			X			
	Lingerie	40°C	X	X										X	X		
30°C		X	X										X	X			
cold		X	X										X	X			
Silk	30°C	X	X									X	X	X			
	cold	X	X									X	X	X			
Baby	40°C	X	X	X			X			X			X	X			
	30°C	X	X	X			X			X			X	X			
	cold	X	X	X			X			X			X	X			
Mini, Flash, Sport, Light	30°C											X	X	X			
Hygienize	90°C	X	X	X	X	X	X		X				X	X	X		

(*) Economy

➤ Cotton: 90°C = Eco 67°C; 60°C = Energy Label; 50°-40°C = Eco 40° C AA

➤ Synthetics: 60-60°C= Eco 40°C

X Option included in the programme and cannot be deleted

		OPTIONS														
		Rinse-hold	Night cycle	Pre-wash	Stains	Bleach	Extra rinse	Easy-iron	Economy (*)	Normal	Daily	Light	Super Quick	Reduced spin speed	No spin	Half-load
Compatibility with PROGRAMMES	Sport	40°C	X	X	X			X			X			X	X	
		30°C	X	X	X			X			X			X	X	
		cold	X	X	X			X			X			X	X	
	Shirts	30°C										X	X			
	Mixed°	40°C	X	X	X	X	X		X				X	X	X	
	Hygienize	90°C	X	X		X		X	X	X				X	X	X
		60°C	X	X		X		X	X	X				X	X	X
		50°C	X	X		X		X	X	X				X	X	X
		40°C	X	X		X		X	X	X				X	X	X
	Soak	30°C											X			
	Rinses		X	X			X	X	X				X	X		
	Rinses delicates		X	X			X						X	X		
	Conditioner		X	X				X					X	X		
	Delicate conditioner		X	X				X					X	X		
	Drain															
Spin													X			
Delicate spin													X			

(*) Economy

➤ Cotton: 90°C = Eco 67°C; 60°C = Energy Label; 50°C = Eco 48°C; 40°C = Eco 44°C AA

➤ Synthetics: 60-60°C = Eco 40°C

X Option included in the programme and cannot be deleted

5.2.1 Compatibility between Options

		OPTIONS															
		Rinse-hold	Night cycle	Pre-wash	Stains	Bleach	Extra rinse	Easy-iron	Economy (*)	Intensive	Normal	Daily	Light	Super Quick	Reduced spin speed	No spin	Half-load
Compatibility with OPTIONS	Rinse-hold			X	X	X	X	X	X	X	X	X	X	X			X
	Night cycle			X	X	X	X		X	X	X	X	X	X			X
	Pre-wash	X	X		(*)	(*)	X	X	X	X	X	X	X	X	X	X	X
	Stains	X	X	(*)		(*)	X	X	X	X	X	X	X	X	X	X	X
	Bleach	X	X	(*)	(*)		X	X	X	X	X	X	X	X	X	X	
	Super rinse	X	X	X	X	X		X	X	X	X	X	X	X	X	X	X
	Easy-iron	X		X	X	X	X		X	X	X	X	X	X	X	X	X
	Economy	X	X	X	X	X	X	X							X	X	X
	Intensive	X	X	X	X	X	X	X							X	X	X
	Normal	X	X	X	X	X	X	X							X	X	X
	Daily	X	X	X	X	X	X	X							X	X	X
	Light	X	X	X	X	X	X	X							X	X	
	Super Quick	X	X	X	X	X	X	X							X	X	
	Reduced spin speed			X	X	X	X	X	X	X	X	X	X	X			X
	No spin			X	X	X	X	X	X	X	X	X	X	X			X
	Half-load	X	X	X	X		X	X	X	X	X	X			X	X	
Phases in which selection or modification are possible	Selection	X	X	X	X	X	X	X	X	X	X	X	X	X	X		
	Pre-wash	X	X		X	X	X	X							X	X	
	Wash	X	X		X	X	X								X	X	
	Rinses	X	X														
	Spin																

(*) Prewash, Stains and Bleach are compatible depending on which detergent drawer is used.

- The delayed start is compatible with all programmes, the max. time that can be selected is 20 hours.
- The spin selection is available for all programmes except for the drain.

The table below shows other limitations in the compatibility of the options due to the drawer type and electric valve number.

	4C-3V	4C-2V	3C-2V
PREWASH / SOAK	▶	▶	▶
BLEACHING	◆	▶	◇
STAINS	▶	▶	▶

4C= 4-compartment drawer

3C= 3-compartment drawer

3V= 3 electric valves

2V= 2 electric valves

◇ = Option not available

◆ = Option available

▶ = Only one of these options can be selected

5.3 Description of options

- **Rinse-hold**
 - Stops the appliance with water in the tub before the final spin cycle.
 - To drain the water, reset the programme and then select a drain or spin cycle.
- **Night cycle**
 - Eliminates all spin phases and adds **three** rinses in COTTON cycles and **two** rinses in SYNTHETICS cycles.
 - Stops the appliance with water in the tub before the final rinse.
 - To drain the water, reset the programme and then select a drain or spin cycle.
- **Pre-wash**
 - Adds a pre-wash phase at the start of the cycle with water heating to 30°C (or cold, if selected).
 - In COTTON and SYNTHETICS cycles, performs a short spin before passing to the washing phase.
 - This option cannot be selected for WOOL and HAND-WASH cycles.
- **Stains**
 - Adds a 5-minute motor movement phase after heating to 40°C.
 - Ducts water to the pre-wash/stains compartment in order to introduce the special stain-removal product.
 - This option cannot be selected for DELICATES, WOOL and HAND-WASH cycles.
- **Bleach**
 - Ducts water through the bleach compartment at the beginning of the first rinse in COTTON cycles.
- **Economy / Energy label**
 - Modifies the structure of the COTTON 40-60 and SYNTHETICS 50/60 programmes in order to reduce energy consumption.
 - Reduces the washing temperature.
 - Increases the duration of the wash phase.
- **Super-rinse**
 - Adds **two** rinses in the COTTON, SYNTHETICS and DELICATES cycles.
 - Eliminates the intermediate spin cycles, with the exception of the final rinse, which is reduced to 450 rpm.
- **Half-load**
 - Eliminates one rinse in COTTON programmes.
- **Easy-Iron**
 - In COTTON programmes:
 - adds **three** rinse cycles
 - eliminates the intermediate spin cycles
 - performs an impulse spin phase
 - adds an “untangling” phase after the spin cycle
 - In SYNTHETICS cycles:
 - reduces the heating temperature in 50/60° cycles to 40°C
 - increases the washing time
 - prolongs the cooling phase at the end of the washing phase
 - adds **one** rinse
 - adds an “untangling” phase after the impulse spin cycle
- **Reduced spin speed**
 - Reduces the speed of **all** spins as shown in the table.

Maximum spin speed (rpm)	600	700	800	900	1000	1100	1200	1300	1400	1550
Reduction for COTTON (rpm)	450	450	450	450	500	550	600	650	700	750
Reduction for ALL OTHER CYCLES (rpm)	450	450	450	450	450	450	450	450	450	450

- **Intensive**
 - Performs a specific intensive cycle.

5.3.1 No spin

- Eliminates **all** the spin phases.
→ If selected, three rinses are added in the COTTON cycle and one in the SYNTHETICS cycle.
- **Daily**
→ Modifies the structure of the COTTON - SYNTHETICS - DELICATES cycles to obtain very short washing times.
- **Light**
→ Modifies the structure of the wash phase of the COTTON - SYNTHETICS - DELICATES cycles in a short time.
- **Very short**
→ Modifies the structure of the wash phase of the COTTON - SYNTHETICS - DELICATES cycles for half load.
- **Delayed-start time**
→ Adds a pause before the start of the programme. The delay time is displayed on the corresponding LEDs starting from a 2-hour till a 20-hour delay.
→ To start the cycle immediately after selecting a delayed start:
 - press START/PAUSE, cancel the delay time by pressing the appropriate button, then press START/PAUSE again.

Example of "delay time" button

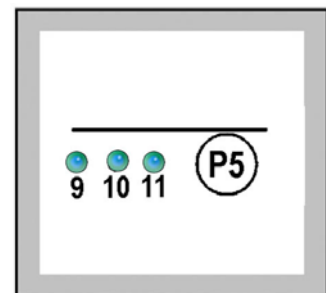

5.3.2 Temperature adjustment

- Used to select the washing temperature compatibly with the limit temperature for the cycle.
- Can be used during the cycle selection phase: the temperature can be modified only if the heating phase has not started (in pause mode).

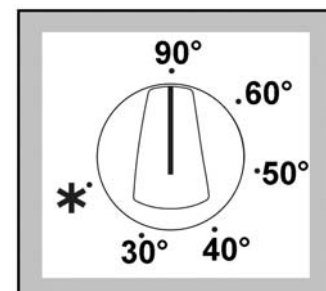

5.3.3 Modifying the spin speed

- Reduces the speed of **all** spin cycles as shown in the table.
- The last position can be used for NO SPIN, RINSE-HOLD or NIGHT-TIME CYCLE.
- If the NO-SPIN option is selected, three rinses are added in the COTTON cycle, and two in the SYNTHETICS cycle.

The tables below list examples of modification of the spin speed.

6-position selector										
1 - Max. spin speed	600	700	800	900	1000	1100	1200	1300	1400	1600
2	550	600	700	800	900	900	900	1100	1200	1200
3	500	500	600	700	700	700	700	900	900	900
4	450	400	500	500	500	500	500	700	700	700
5	No spin or Night cycle	No spin or Night cycle	No spin or Night cycle	No spin or Night cycle	No spin or Night cycle	No spin or Night cycle	No spin or Night cycle	No spin or Night cycle	No spin or Night cycle	No spin or Night cycle
6 - Last position	Rinse-hold	Rinse-hold	Rinse-hold	Rinse-hold	Rinse-hold	Rinse-hold	Rinse-hold	Rinse-hold	Rinse-hold	Rinse-hold

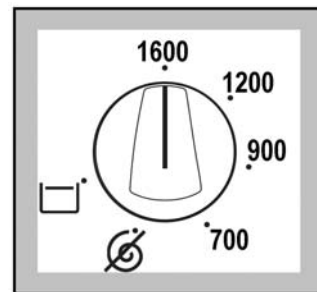
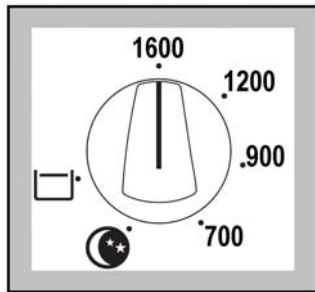

Button with 5 LEDs						
1 - Max. spin speed	600/700	800/900	1000÷1600	1000÷1600	1300÷1600	1400÷1600
2	500	700	900	900	1100	1200
3	400	500	700	700	900	900
4	No spin or Night cycle	No spin or Night cycle	No spin or Night cycle	500	700	700
5 - Last value	Rinse-hold	Rinse-hold	Rinse-hold	No spin or Rinse-hold	No spin or Rinse-hold	No spin or Rinse-hold

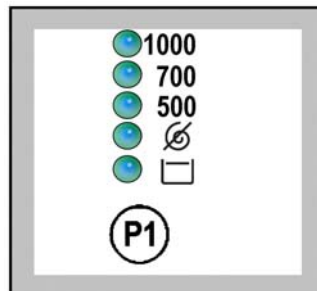

5.4 Modification of rinses on the basis of the options

		No. of rinses with the options							
		Normal	Super rinse	Night cycle	Easy-iron	No spin	Half load	(Night cycle Easy-iron No spin) and Super-rinse	
PROGRAMMI	COTTON (D,N, B) Low	Eco 90°	3	5	6	6	6	2	7
		Eco 60°	2	4	5	5	5	2	6
		Eco 40°-50°	3	5	6	6	6	2	7
		Intensive	3	5	6	6	6	2	7
		Normal	3	5	6	6	6	2	7
		Daily	3	5	6	6	6	2	7
		Light	2	4	5	5	5	2	6
		Short	2	4	5	5	5	2	6
		Very short	2	4	5	5	5	2	6
	COTTON (I, F, UK, E) Medium	Eco 90°	3	5	6	6	5	2	7
Eco 60°		3	5	6	6	6	2	7	
Eco 40°-50°		3	5	6	6	6	2	7	
Intensive		3	5	6	6	6	2	7	
Normal		3	5	6	6	6	2	7	
Daily		3	5	6	6	6	2	7	
Light		2	4	5	5	5	2	6	
Short		2	4	5	5	5	2	6	
Very short		2	4	5	5	5	2	6	
COTTON (SWE) High	Eco 90°	3	5	6	6	6	2	7	
	Eco 60°	3	5	6	6	6	2	7	
	Eco 40°-50°	3	5	6	6	6	2	7	
	Intensive	3	5	6	6	6	2	7	
	Normal	3	5	6	6	6	2	7	
	Daily	3	5	6	6	6	2	7	
	Light	2	4	5	5	5	2	6	
	Short	2	4	5	5	5	2	6	
	Very short	2	4	5	5	5	2	6	
SYNTHETICS	Eco 60'	3	4	5	5	5	2	6	
	Eco 40°- 50°	3	4	5	5	5	2	6	
	Intensive / Normal	3	4	5	5	5	2	6	
	Daily	3	4	5	5	5	2	6	
	Light	2	3	4	4	4	2	5	
	Short / Very short	2	3	4	4	4	2	5	
DELICATES	Intensive / Normal	3	4	5	5	5	2	6	
	Daily	3	4	5	5	5	2	6	
	Light	2	3	4	4	4	2	5	
	Short / Very short	2	3	4	4	4	2	5	
DUVETS	Normal	3	4			4		5	
WOOL	Normal	3	3			3		3	
HAND WASH	Normal	3	3			3		3	
SILK	Normal	2	3			4		5	
JEANS	Normal	5				8			

The half-load option reduces of 1 rinse all cotton programmes except the Very short (Quick).

6 TECHNICAL CHARACTERISTICS

6.1 Control system memory



6.1.1 General structure of the memory system

The system features an EEPROM memory module, fitted externally to the microprocessor, which serves to memorize the configuration data, the description of the cycle, the status of the appliance in the event of a power failure, and the alarms.

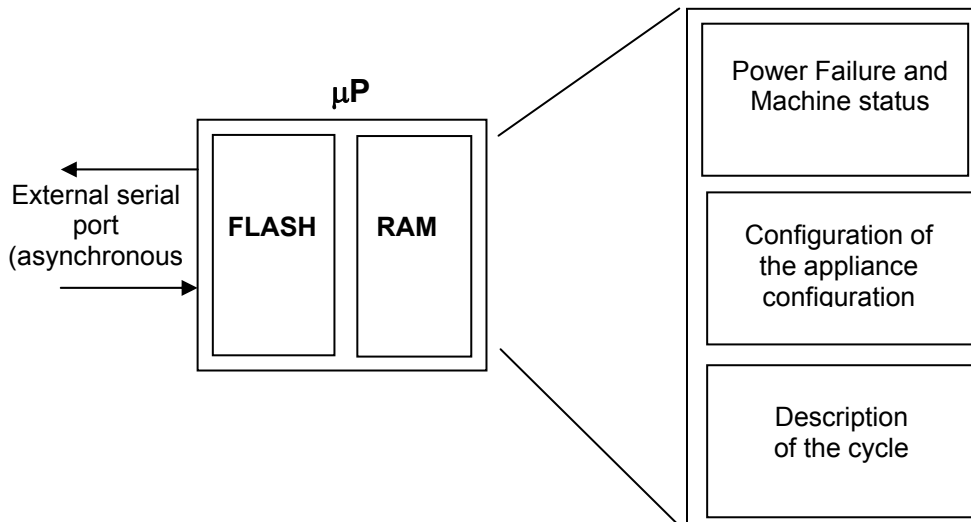

6.1.2 FLASH

This area memory contains the firmware code relative to the functions of the appliance:

- ⇒ Control of electrical loads (motor, pump, solenoid valves etc.).
- ⇒ Control of the sensors (pressure switches, motor speed, door status etc.).
- ⇒ Control of the user interface
- ⇒ Control of the serial port
- ⇒ Control of power failure procedure and alarms
- ⇒ Execution of the washing programme
- ⇒ Power failure, i.e. the information necessary to restart the appliance in the event of a power failure:
 - Selected cycle and options
 - Current phase and sub-phase
- ⇒ Machine status, used to perform special cycles such as:
 - Electrical test (used in the assembly line)
 - Continuous cycles (used in the factory workshop)
- ⇒ Machine configuration: the data contained in the EEPROM define the characteristics of the model and are interpreted by the function software. The variables are as follows:
 - Type of appliance (front-loader, top-loader, compact)
 - Type of door interlock (PTC or instantaneous)
 - Anti-flooding safety device
 - Transmission ratio between drum pulley and motor pulley
 - Structure of the washing group
 - Power supply frequency (50/60 Hz)
 - Type of PCB (horizontal or vertical buttons)
 - Detergent drawer (3 or 4 compartments)
 - Final spin speed (600 – 1400 rpm)
- ⇒ Identification of the appliance:
 - Prod. N.
 - ELC
 - Serial number
- ⇒ Configuration of the user interface:
 - Programmes on main selector
 - Function of secondary selector (if featured)
 - Number and functions of buttons
 - Functions of the LEDs
 - Operation of the buzzer

- ⇒ Washing cycle tables: Each washing cycle consists of a series of phases (steps); the steps are the basic instructions which comprise the description of the cycle, which is common to all appliances having the same characteristics:
 - Water fill
 - Motor movement
 - Reset
 - Heating
 - Drain
 - Spin
 - "IF" conditions (options, temperatures etc.)
- ⇒ Configuration of the washing cycle: for each family of appliances, certain parameters associated with the washing programme are defined:
 - Operational limits (voltage/frequency)
 - Transmission ratios
 - Parameters for control of the signal from the tachometric generator
 - Parameters for half-range operation of the motor
 - Structure of the washing group
 - Control parameters for the FUCS anti-unbalancing system
 - Water fill control algorithm
 - Alarm control system
 - Sensor parameters (flowmeter etc...)

6.1.3 RAM

The RAM (Random-Access Memory) contains the variables, i.e. all the dynamic information used during execution of the programme:

- ⇒ Motor speed
- ⇒ Water temperature
- ⇒ Alarms
- ⇒ Cycle selected
- ⇒ Machine status

The RAM is cancelled when the power supply is disconnected (power failure or appliance switched off).

The contents of the RAM can be read using a computer connected via a DAAS interface.

The same system can be used to send commands to the electronic control unit such as:

- ⇒ Select remote control mode
- ⇒ Action the various loads in remote mode
- ⇒ Select diagnostics mode
- ⇒ Select a cycle and options, and start the cycle

6.2 Door interlock

The voltmetric device with PTC takes 1÷3 minutes before opening the door after the end of the cycle.

- 14 PCB
- 12 Door interlock
- 11 Suppressor

ON/OFF = Main switch (programme selector)

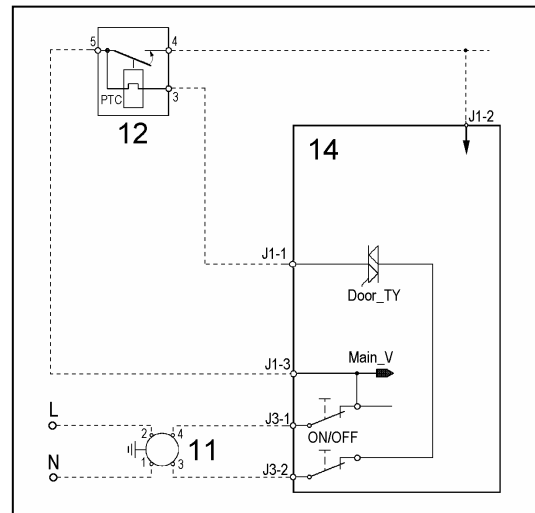

6.2.1 Operating principle

- When the washing programme is started by pressing the START/PAUSE button, the bi-metal PTC (contacts 3-5) is powered by the triac on the PCB: after 2 – 4 seconds, this closes the switch (5-4) which powers the electrical components of the appliance (only if the door is closed).
- The door interlock prevents aperture of the door while the appliance is in operation.
- At the end of the washing programme, the PCB disconnects the interlock from the power supply, but the door remains locked for 1 to 2 minutes (PTC cooling time).

6.3 Water drain system

The electric valves are powered by the PCB by means of the triac and the control of the water level in the tub is carried out by the analogue pressure switch.

- 1 Analogue pressure switch
- 3 Prewash electric valve
- 4 Wash electric valve
- 14 PCB

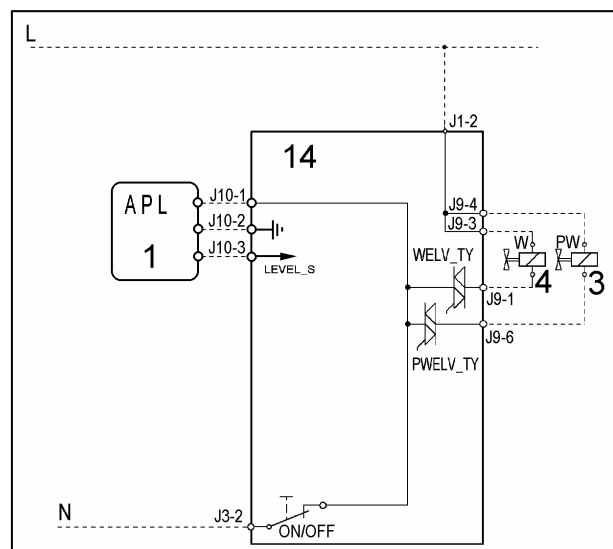

6.4 Analogue pressure switch of water level control in the tub

General features

The electronic pressure switch is an analogue device that controls the water level in the tub, used in the models with electronic control and it is directly connected to the main PCB.

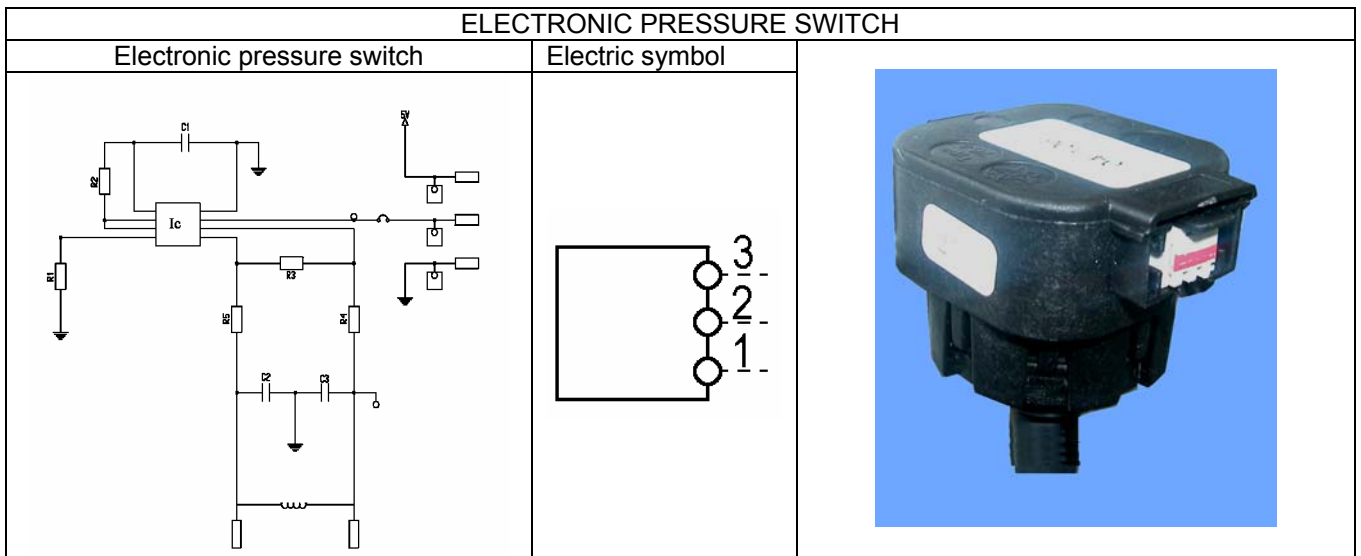

The pressure switch is connected by a hose to the pressure chamber.

When the tub is filled with water, the pressure created inside the hydraulic circuit expands the diaphragm. This in turn modifies the position of the core inside the coil, thus changing the inductance and the frequency of the oscillating circuit.

The electronic PCB, according to the frequency, recognizes the quantity of the water in the tub.

1 hose
3 coil
5 core

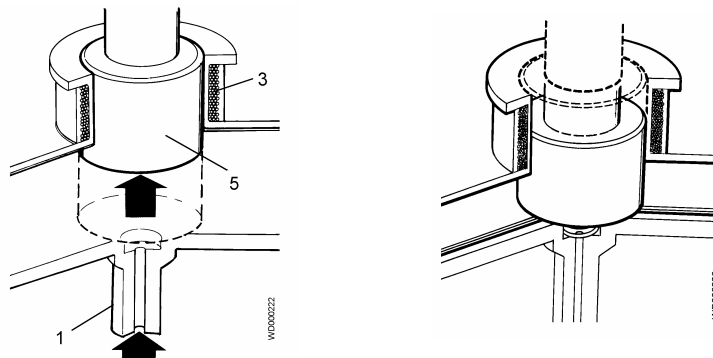

Frequency variation according to the water quantity in the tub

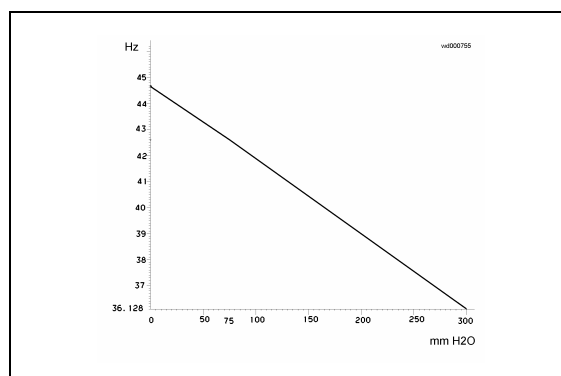

6.5 Detergent dispenser

There are two versions of the detergent drawer: one large drawer and one smaller (ecological) drawer.

6.5.1 "Short" detergent dispenser

1. Fill hose
2. Water fill solenoid
3. Hoses
4. Nozzle
5. Detergent dispenser duct
6. Siphon for conditioners
7. Detergent drawer
8. Detergent dispenser
9. Detergent intake tube
10. Clamp

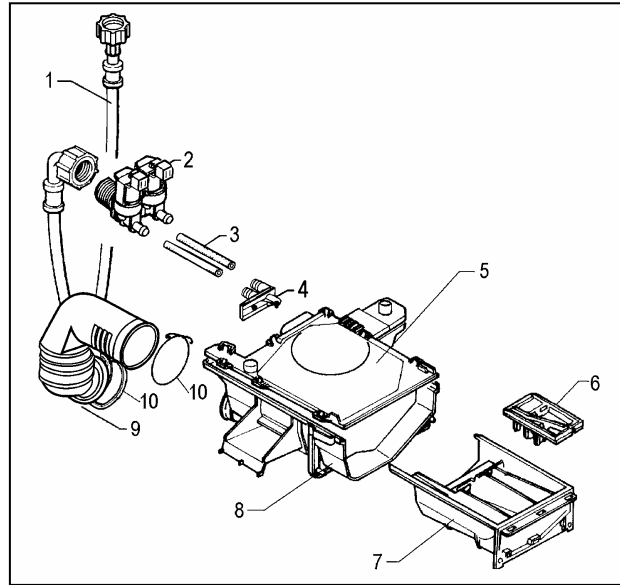

Version with three compartments	Version with four compartments
<ul style="list-style-type: none"> • Duct with 4 compartments, • Two-way water intake nozzle • 3-compartment detergent drawer 	<ul style="list-style-type: none"> • Duct with 4 compartments and fork • Two-way water intake nozzle • 4-compartment detergent drawer
3 - 4 compartments: 2-way solenoid valve	

6.5.1.1 Operating principle

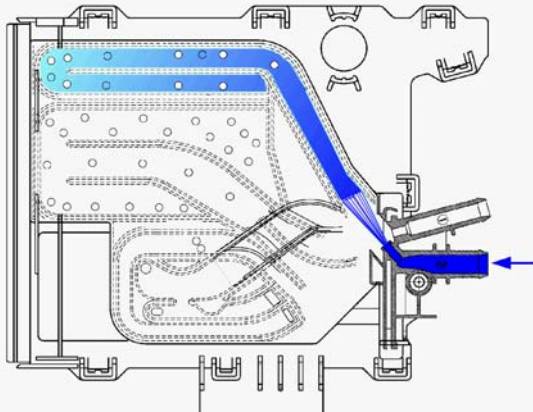
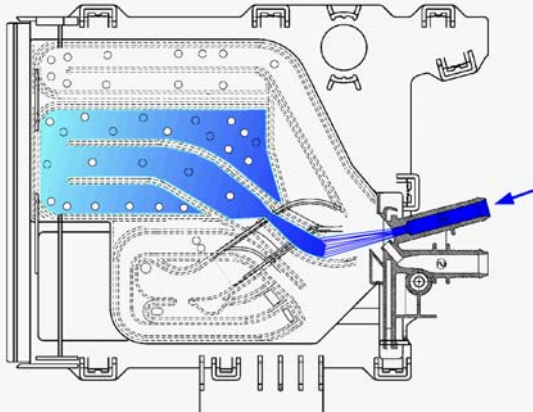
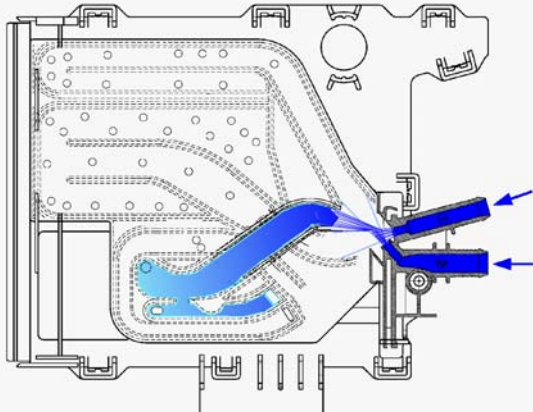
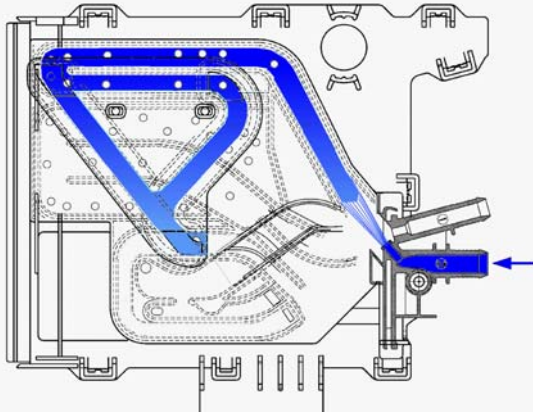
<p>Water fill to pre-wash compartment (pre-wash solenoid)</p> <ul style="list-style-type: none"> • This solution is used in models with 3-compartment detergent drawers. The detergent in compartment “a” is introduced at the beginning of the pre-wash phase. • In certain models featuring the “stains” option, compartment “a” may also be used for introduction of a stain-removal product, which is introduced during the washing phase. 	
<p>Water fill to wash compartment (wash solenoid)</p> <ul style="list-style-type: none"> • In all models, compartment “b” contains the detergent, which is introduced at the beginning of the washing phase. 	
<p>Water fill to conditioner compartment (pre-wash/wash solenoids)</p> <ul style="list-style-type: none"> • In all models, compartment “d” contains the conditioner, which is introduced at the beginning of the final rinse. 	
<p>Water fill to pre-wash and bleach compartments (pre-wash solenoid)</p> <ul style="list-style-type: none"> • In models with four compartments, water is ducted through compartments “a” and “c”, which are not used simultaneously. • If the user selects the pre-wash option, water is ducted through compartments “a” and “c” at the beginning of the pre-wash phase. • If this option is not selected, the water is ducted through the compartments at the beginning of the first rinse. 	

6.5.2 “Long” detergent dispenser

1. Fill hose
2. Water fill solenoid (cold)
3. Hose
4. Nozzle
5. Detergent dispenser duct
6. Siphon for conditioners
7. Detergent drawer
8. Clamp
9. Detergent intake tube
10. Detergent dispenser

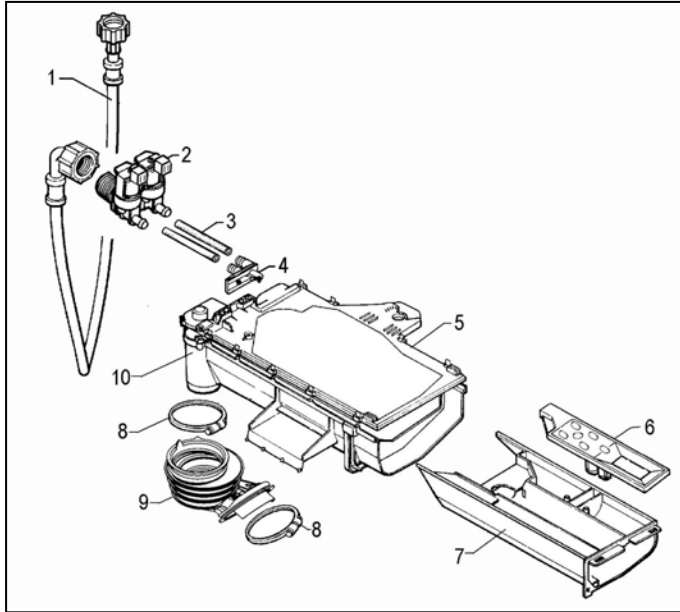

Version with three compartments

Version with four compartments

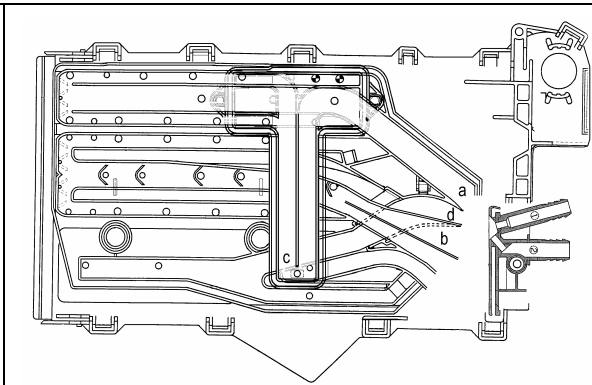
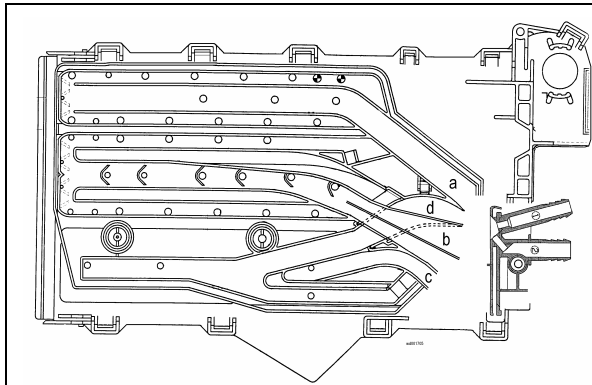

- Duct with 4 compartments
- Two-way water intake nozzle
- 3-compartment detergent dispenser

- Duct with 4 compartments and “flow deviator”
- Two-way water intake nozzle
- 4-compartment detergent dispenser

3 - 4 compartments: 2-way solenoid valve

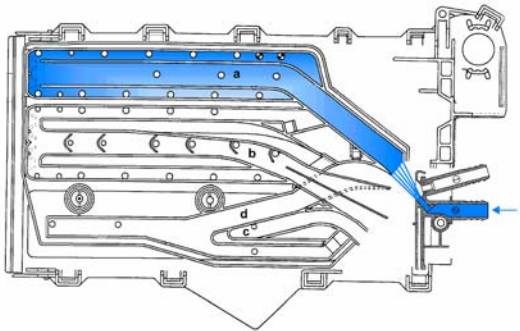
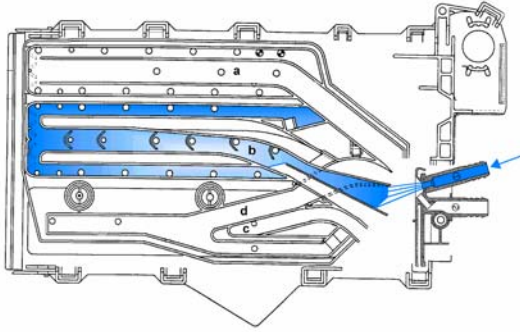
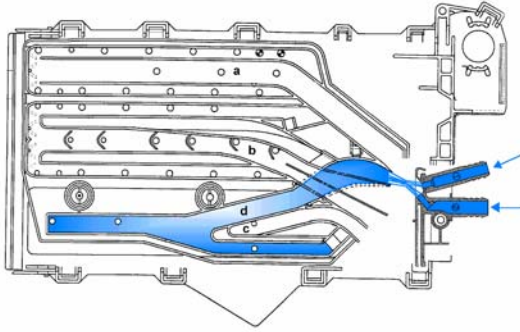
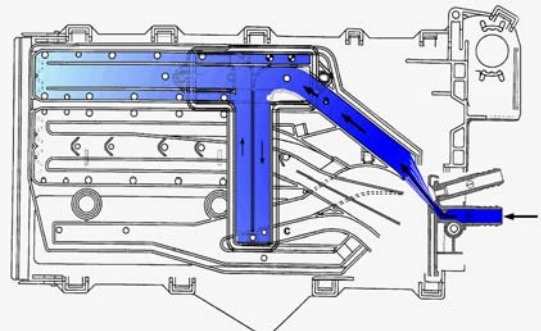

6.5.2.1 Operating principle

<p style="text-align: center;">Water fill to pre-wash compartment (pre-wash solenoid)</p> <ul style="list-style-type: none"> • This solution is used in models with 3-compartment detergent drawers. The detergent in compartment “a” is introduced at the beginning of the pre-wash phase. • In certain models featuring the “stains” option, compartment “a” may also be used for introduction of a stain-removal product, which is introduced during the washing phase. 	 <p>The diagram shows a cross-section of a detergent drawer with three compartments labeled 'a', 'b', and 'c'. Water is shown being poured into compartment 'a' from a solenoid on the right. The water level is high in 'a' and lower in 'b' and 'c'. The drawer is mounted in a machine housing.</p>
<p style="text-align: center;">Water fill to wash compartment (wash solenoid)</p> <ul style="list-style-type: none"> • In all models, compartment “b” contains the detergent, which is introduced at the beginning of the washing phase. 	 <p>The diagram shows the same detergent drawer. Water is now being poured into compartment 'b' from a solenoid on the right. The water level is high in 'b' and lower in 'a' and 'c'.</p>
<p style="text-align: center;">Water fill to conditioner compartment (pre-wash/wash solenoids)</p> <ul style="list-style-type: none"> • In all models, compartment “d” contains the conditioner, which is introduced at the beginning of the final rinse. 	 <p>The diagram shows a detergent drawer with four compartments labeled 'a', 'b', 'c', and 'd'. Water is being poured into compartment 'd' from a solenoid on the right. The water level is high in 'd' and lower in 'a', 'b', and 'c'.</p>
<p style="text-align: center;">Water fill to pre-wash and bleach compartments (pre-wash solenoid)</p> <ul style="list-style-type: none"> • In models with 4 compartments, water is ducted through compartments “a” and “c”, which are not used simultaneously. • If the user selects the pre-wash option, water is ducted through compartments “a” and “c” at the beginning of the pre-wash phase. • If this option is not selected, the water is ducted through the compartments at the beginning of the first rinse. 	 <p>The diagram shows a detergent drawer with four compartments labeled 'a', 'b', 'c', and 'd'. Water is being poured into compartments 'a' and 'c' from a solenoid on the right. The water level is high in 'a' and 'c' and lower in 'b' and 'd'.</p>

6.6 Drain pump

- 9 Drain pump
- 10 Thermal protector
- 14 PCB

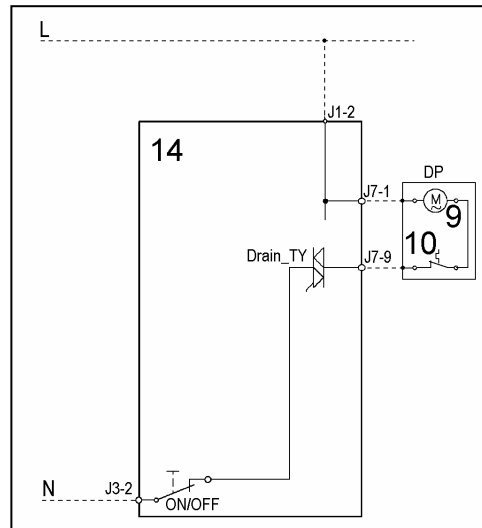

The PCB powers the drain pump via a triac as follows:

- until the anti-boiling pressure switch closes on EMPTY, after which the pump is actioned for a brief period or passes to the subsequent phase;
- for a pre-determined period (and eventually an alarm appears).

6.7 Heating



- 2 NTC temperature sensor
- 13 Heating element (with thermal fuses)
- 14 PCB
- K1 Relay

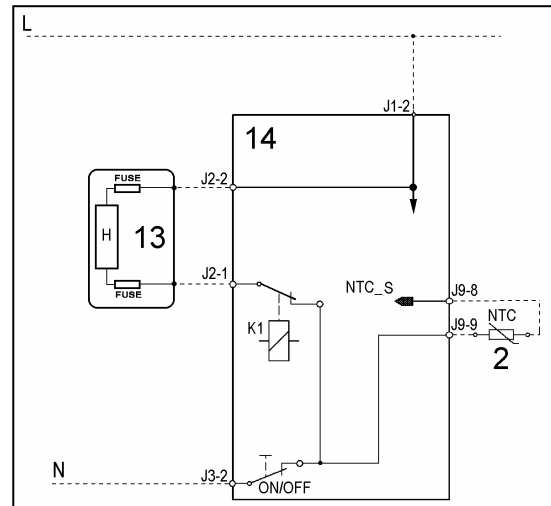

- 1. Tubular casing
- 2. Thermal fuses
- 3. NTC Sensor
- 4. Connectors

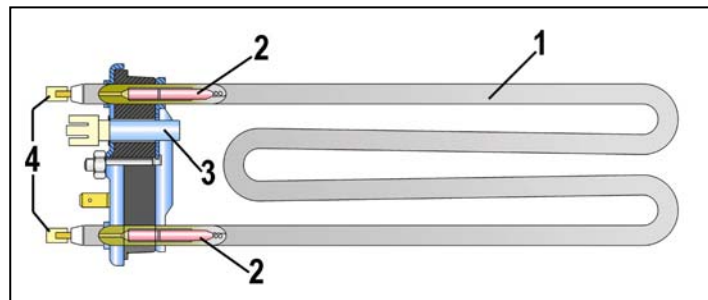

The heating element is powered by a relay (K1) of the electronic board and is provided with two thermal fuses, which interrupt if the temperature degree exceeds the values by which they are calibrated.

WARNING



In case of replacement of the heater, replace it with one with the same characteristics in order not to compromise the safety of the appliance.

6.8 Temperature sensor

The temperature is controlled by the PCB by means of a NTC temperature sensor incorporated in the heating element.

- 1. NTC resistor
- 2. Metallic capsule
- 3. Terminals
- 4. Plastic casing

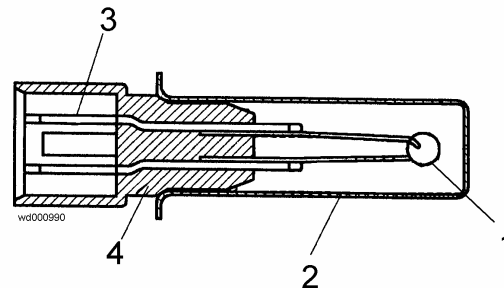

TEMPERATURE (°C)	RESISTANCE (Ω)		
	Nominal value	Maximum value	Minimum value
20	6050	6335	5765
60	1250	1278	1222
80	640	620	660

6.9 Motor

- 5 Stator
- 6 Rotor
- 7 Protector
- 8 Tachometric generator
- 14 PCB

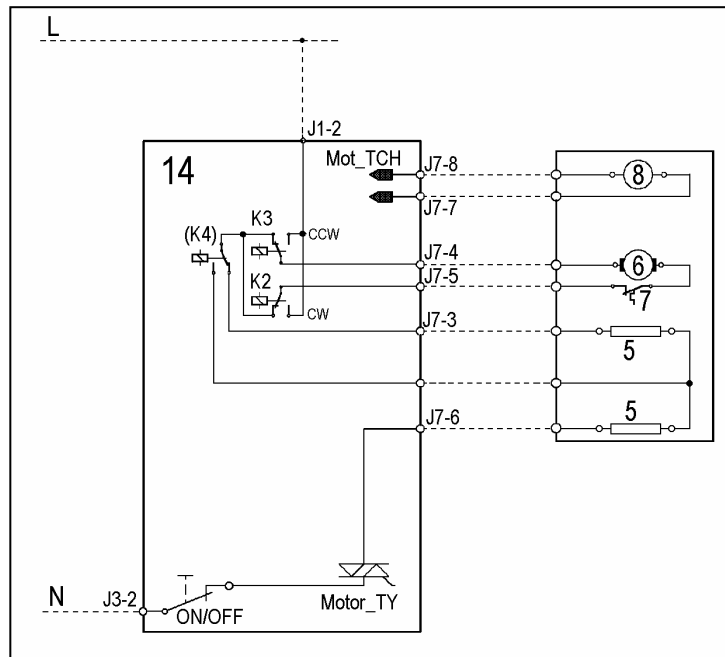

6.10 Power supply to motor

The PCB powers the motor via a triac. The direction of rotation is reversed by switching of the contacts on the two relays (K2-K3), which modify the connection between the rotor and the stator.

In certain models, a third relay (K4) is used to power the stator (full or half field) according to the spin speed. The speed of rotation of the motor is determined by the signal received from the tachometric generator.

During the spin phases, the microprocessor, depending on the software configuration, may perform the anti-foam control procedure and the anti-unbalancing control procedure.

6.11 Anti-foam control system

The anti-foam control procedure (if featured) is performed via the anti-boiling pressure switch.

Spin phase without foam

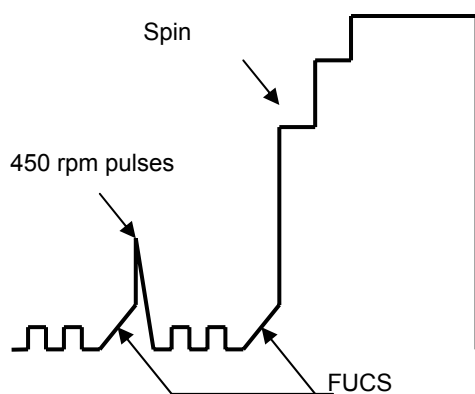

Spin phase with little foam

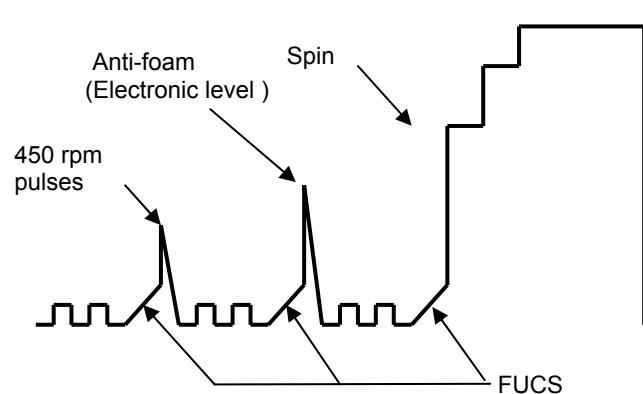

- **Spin with little foam:** if the contact of the electronic pressure switch closes on FULL, the spin phase is interrupted; the drain pump continues to operate and, when the contact returns to EMPTY, the spin phase is resumed.
- **Spin with excessive foam in the tub (critical situation):** The control system detects whether the electronic pressure switch commutates 5 times to FULL. In this case, the spin phase is skipped, and a one-minute drain cycle is performed with the motor switched off; in the case of a washing phase, a supplementary rinse is added.

6.12 “FUCS” (Fast Unbalance Control System)

The control procedure for unbalanced loads is performed dynamically, before each spin cycle, as follows:

- ↪ The phase begins at a speed of 55 rpm; the speed can never fall below this threshold, otherwise the check is repeated.
- ↪ At intervals of 300 ms, the balance is calculated and compared with predetermined limits. If the value is less than the lower limit, the speed of the drum is increased by a certain value depending on the transmission relation between motor pulley/drum; if the unbalancing is higher, it is decreased by the same value. The reduction in the speed of the drum distributes the washing correctly; this procedure is repeated until the wash load is completely balanced.
- ↪ Correct balancing of the wash load is achieved at a speed of 115 rpm, after which the spin cycle begins.

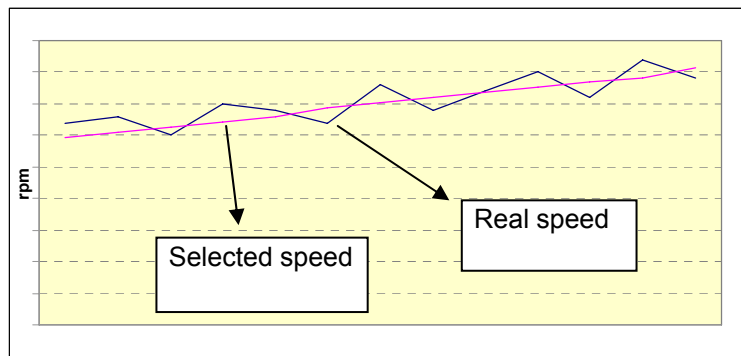

The Unbalancing Control function takes place in different phases: each phase is characterized by:

- ↪ an unbalancing index (0-1-2-3)
- ↪ an unbalancing threshold value (ex: 850, 350, 650, 1100rpm)
- ↪ a time out (max. time)

- **Ending of the FUCS balancing phase**

The phase is ended when:

- ↪ The drum rotation speed is 115 rpm (or 85rpm in some cases of unbalancing index). In this case the spin is performed.
- ↪ In some cases the optimal balancing value is not reached: a reduced spin is performed depending on the unbalancing.
- ↪ In the worst case, in which all phases are not sufficient to reach a minimum balancing value, the spin is not performed.

- **Example of perfect balancing**

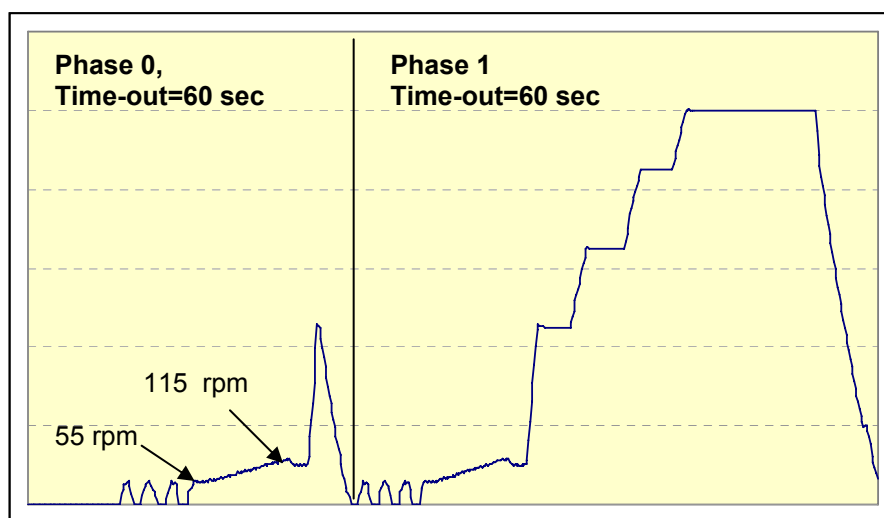

- **Balancing in the available longer interval**

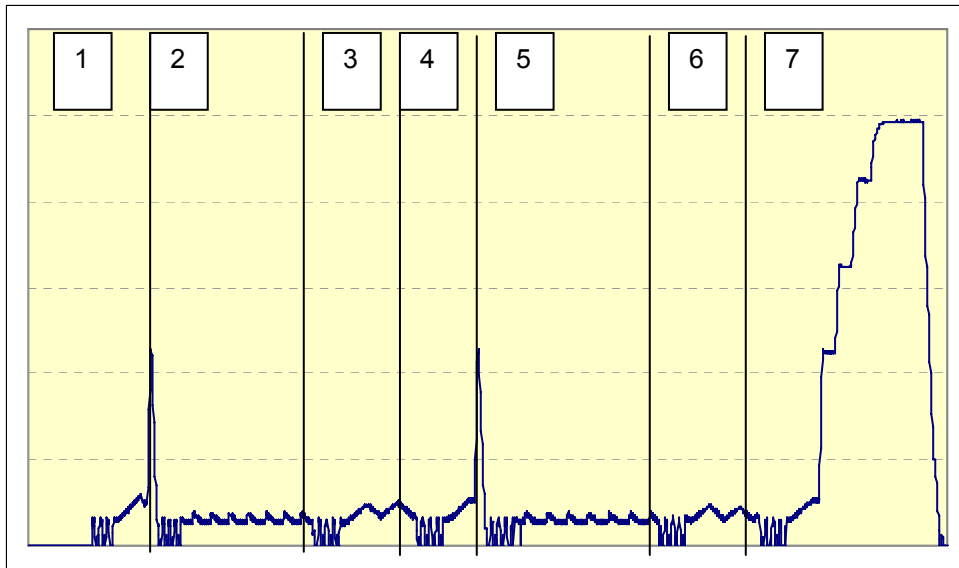

Phase	Unbalancing index	Time-out (sec)
1	0	60
2	1	120
3	2	60
4	3	90
5	1	120
6	2	90
7	3	90

- **Unbalancing after all phases**

In this case the spin (or impulse) is not performed

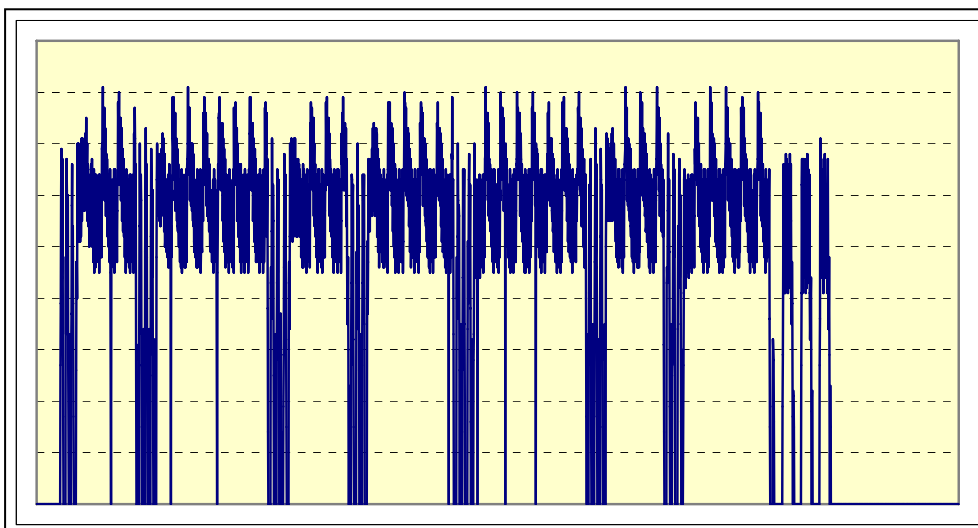

7 DEMO MODE

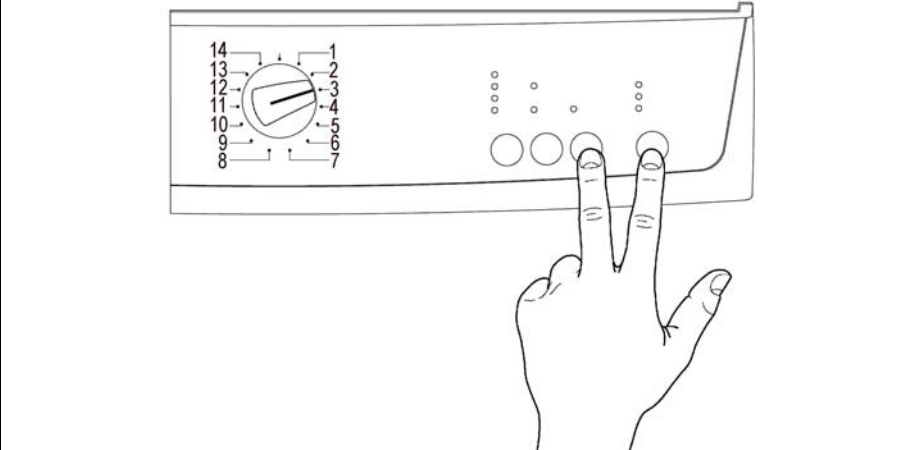

1. Switch off the appliance.
2. Press and hold down **START/PAUSE** button and the nearest **option button** simultaneously (as represented in figure).
3. Holding down both buttons, switch the appliance on by turning the programme selector by **three positions clockwise**.
4. Continue to hold down the buttons till the LEDs begin to flash (at least 5 seconds).

7.1 Exiting DEMO mode

To exit the demo cycle, switch the appliance off (programme selector in off/cancel position).

8 DIAGNOSTICS SYSTEM

8.1 Access to diagnostics mode

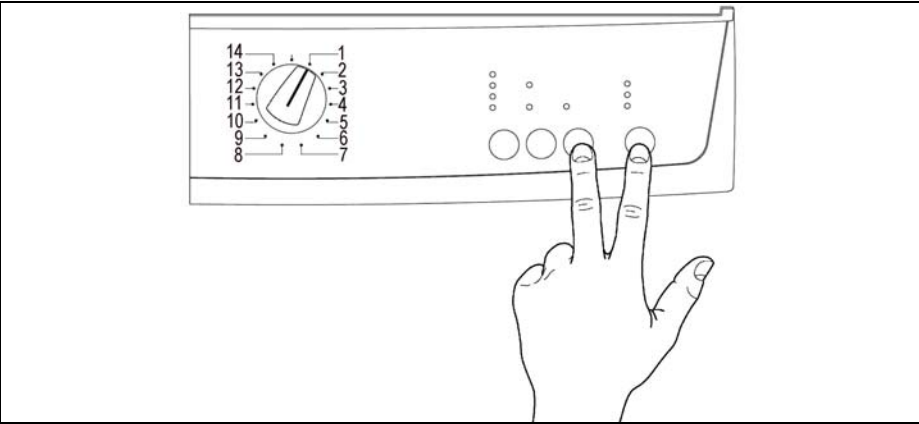

1. Switch off the appliance.
2. Press and hold down **START/PAUSE** button and the nearest **option button** (as represented in figure).
3. Holding down both buttons, switch the appliance on by turning the programme selector by **one position clockwise**.
4. Continue to hold down the button till the LEDs begin to flash (at least 2 seconds).

In the first position, the operation of the buttons and the relative LEDs is checked; turning the selector knob **clockwise** the diagnostics cycle for the operation of the various components and the alarm reading is activated.

8.2 Exiting diagnostics mode

→ To exit the diagnostics cycle, switch the appliance off, then on, and then off again.

8.3 Diagnostics phases

Irrespective of the type of PCB and the configuration of the programme selector it is possible, after entering diagnostics mode, to perform diagnostics on the operation of the various components and to read the alarms by turning the programme selector **clockwise**.

All the alarms are enabled during the diagnostics cycle.

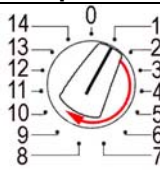
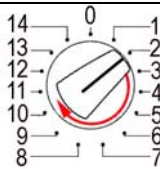
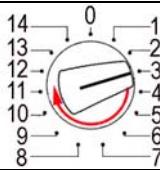
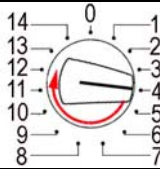
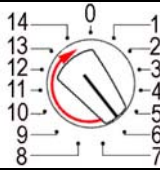
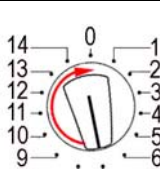
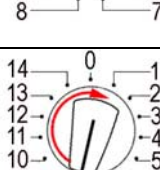
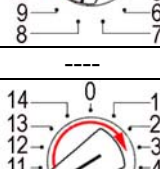
Selector position	Components actioned	Operating conditions	Function checked
 <p>1</p>	<ul style="list-style-type: none"> - All the LEDs light in sequence - When a button is pressed, the corresponding LED lights 	Always activated	Operation of the user interface
 <p>2</p>	<ul style="list-style-type: none"> - Door interlock - Wash solenoid 	Door locked Water level below anti-flooding level Maximum time 5 minutes	Water ducted through washing compartment
 <p>3</p>	<ul style="list-style-type: none"> - Door interlock - Pre-wash solenoid 	Door locked Water level below anti-flooding level Maximum time 5 minutes	Water ducted through pre-wash compartment (bleach)
 <p>4</p>	<ul style="list-style-type: none"> - Door interlock - Pre-wash and wash solenoids 	Door locked Water level below anti-flooding level Maximum time 5 minutes	Water ducted through conditioner compartment
 <p>6</p>	<ul style="list-style-type: none"> - Door interlock - Wash solenoid if the level of water in the tub does not cover the heater - Heating element 	Door locked Water level above the heater Maximum time 10 minutes or up to 90°C (*)	Heating
 <p>7</p>	<ul style="list-style-type: none"> - Door interlock - Wash solenoid if the level of water in the tub does not cover the heater - Motor (55 rpm clockwise, 55 rpm counter-clockwise, 250 rpm impulse) 	Door locked Water level above the heater	Check for leaks from the tub
 <p>8</p>	<ul style="list-style-type: none"> - Door interlock - Drain pump - Motor up to 650 rpm then at maximum spin speed 	Door locked Water level lower than anti-boiling level for spinning	Drain and spin; control of congruence in closure of level pressure switches
9	----	----	----
 <p>10</p>	<ul style="list-style-type: none"> - Reading/Cancellation of the last alarm 	-----	-----

(*) In most cases, this time is sufficient to check the heating. However, the time can be increased by repeating the phase without draining the water: pass for a moment to a different phase of the diagnostics cycle and then back to the heating control phase (if the temperature is higher than 80°C, heating does not take place).

(**) The check at the maximum speed occurs without control of the FUCS and no clothes have to be inserted inside the appliance.

9 ALARMS

9.1 Displaying the alarms to the user

The alarms displayed to the user are listed below:

- ↵ **Door open**
- ↵ **Drain difficulty (dirty filter)**
- ↵ **Water fill difficulty (closet tap)**

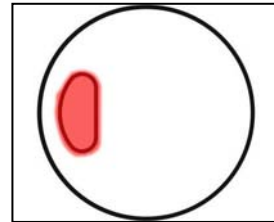

They are represented through the flashing of the red LED inside the START-PAUSE and can be solved directly by the user.

The alarms listed below, instead:

- ↵ **Water leakage (Aqua Control System)**
- ↵ **Low electric voltage**
- ↵ **Irregular frequency of the electric network**

are displayed to the user, but for their solution it is necessary the intervention of the Service.

The alarms are enabled during the execution of the washing programme, with the exception of alarms associated with configuration and the power supply (voltage/frequency), which are also displayed during the programme selection phase.

The door can normally be opened (except where specified) when an alarm condition has occurred on condition that:

- The level of the water in the tub is below a certain level
- Water temperature lower than 55°C
- Motor stopped

Certain alarm conditions require that a drain phase be performed before the door can be opened for safety reasons:

- Cooling water fill if the temperature is higher than 65°C
- Drain until the analogue pressure switch is on empty, during a max. 3-minute time.

9.2 Reading the alarm codes

It is possible to display the last three memorised alarms in the FLASH memory of the electronic board:

- Enter diagnostics mode (par. 9.1).
- Irrespective of the type of PCB and configuration, turn the programme selector **clockwise** to the **tenth position**.
- The last alarm is displayed.
- To display the previous alarms, press sequentially the left button of the START/PAUSE button (as represented in figure).

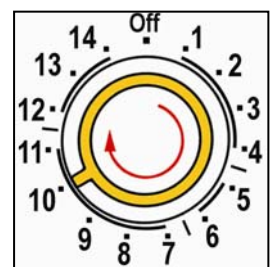

- To return to the last alarm press the START/PAUSE button.

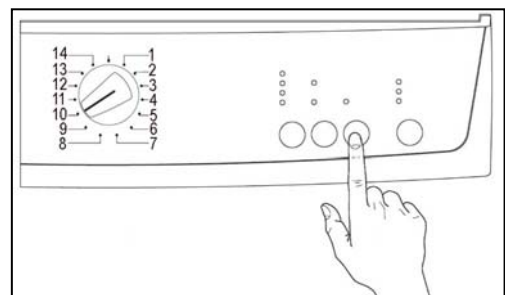

9.2.1 Displaying the alarm

The alarm is displayed by a repeated flashing sequence of the START / PAUSE button with red and green light (0,5 seconds on, 0,5 seconds off with a 2,5 second pause between the sequences).

- button indicator START / PAUSE with red light → indicates the first digit of the alarm code (family)
- button indicator START / PAUSE with green light → indicates the second digit of the alarm code (internal number of the family)

These two LEDs are featured in all models.

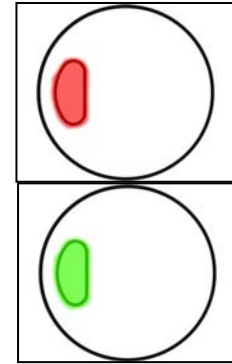

Notes:

- The first letter of the alarm code “E” (Error) is not displayed, since this letter is common to all alarm codes.
- The alarm code “families” are shown in hexadecimal; in other words:
 - **A** is represented by **10** flashes
 - **B** is represented by **11** flashes
 - ...
 - **F** is represented by **15** flashes
- Configuration errors are shown by the flashing of all the LEDs (user interface not configured).

9.2.2 Examples of alarm display

Example: Alarm E43 (problems with the door interlock Triac) will display the following:

- the sequence of four flashes of the START / PAUSE button with red light, indicates the first number **E43**;
- the sequence of three flashes of the START / PAUSE button with green light, indicates the second number **E43**;

START / PAUSE button with red light			START / PAUSE button with green light		
ON / OFF	Time (Sec.)	Value	ON / OFF	Time (Sec.)	Value
	0.5	1		0.5	1
	0.5			0.5	
	0.5	2		0.5	2
	0.5			0.5	
	0.5	3		0.5	3
	0.5			0.5	
	0.5	4		2.5	Pause
	0.5				
	1.5	Pause			

9.2.3 Operation of alarms during diagnostics

All alarms are enabled during the components diagnostics phase.

9.3 Rapid reading of alarm codes

The last three alarm codes can be displayed even if the programme selector is not in the tenth position (diagnostics) or if the appliance is in normal operating mode (e.g. during the execution of the washing programme):

- Press and hold down **START/PAUSE** and the nearest **option button** (as to enter the DIAGNOSTICS), for at least two seconds: the LEDs initially switch off, and then display the flashing sequence indicating the last alarm.
- To display the previous alarms press the left button of the START/PAUSE button sequentially.
- To return to the last alarm press the START/PAUSE button.
- The alarm sequence continues as long as the two buttons are held down.
- The alarm reading system is as described in paragraph 10.2.1.
- While the alarms are displayed, the appliance continues to perform the cycle or, if in the programme selection phase, maintains the previously-selected options in memory.

9.4 Cancelling the last alarm

It is good practice to cancel the last alarm:

- after reading the alarm code, to check whether the alarm re-occurs during diagnostics;
- after repairing the appliance, to check whether it re-occurs during testing.

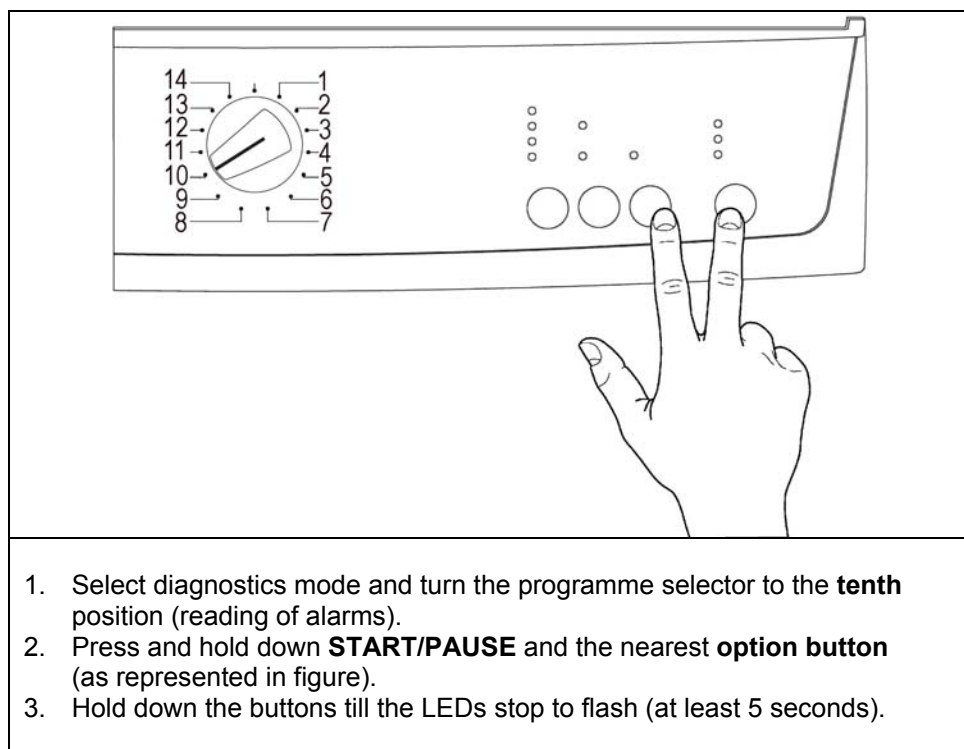

N.B. With this operation all the memorised alarms are deleted.

9.5 Table of alarm codes

Alarm	Possible fault	Action/machine status	Reset
E11	Tap closed or water pressure too low; Drain tube improperly positioned; Water fill solenoid valve is faulty; Leaks from water circuit on pressure switch; Pressure switch faulty; Wiring faulty; PCB faulty.	Cycle is paused with door locked.	START/RESET
E13	Drain tube improperly positioned; Water pressure too low; Water fill solenoid valve is faulty; Water circuit on pressure switch is leaking/clogged; Pressure switch faulty.	Cycle is paused with door locked.	START/RESET
E21	Drain tube kinked/clogged/improperly positioned; Drain filter clogged/dirty; Drain pump faulty; Pressure switch faulty; Wiring faulty; PCB faulty; Electrical current leak between heating element and ground.	Cycle is paused (after 2 attempts).	START/RESET
E23	Drain pump faulty; Wiring faulty; PCB faulty.	Safety drain cycle - Cycle stops with door unlocked.	RESET
E24	PCB faulty.	Safety drain cycle - Cycle stops with door unlocked.	RESET
E31	Pressure switch; Wiring; Main PCB.	Cycle stops with door locked.	RESET
E32	Drain tube kinked/clogged/improperly positioned; Drain filter clogged/dirty; Drain pump faulty; Water circuit on pressure switch; pressure switch; Wiring; main board.	Cycle is paused.	START/RESET
E35	Water fill solenoid valve is faulty; Leaks from water circuit on pressure switch; Pressure switch faulty; Wiring faulty; PCB faulty.	Cycle stops. Safety drain cycle. Drain pump continues to operate (5 min. on, then 5 min. off, etc.).	RESET
E38	Water circuit on pressure switches; Pressure switches; Motor belt broken.	Heating phase is skipped.	ON/OFF RESET
E3A	PCB faulty.	Cycle stops with door locked.	RESET
E41	Door lock unit faulty; Wiring faulty; PCB faulty.	Cycle is paused.	START/RESET
E42	Door lock unit faulty; Wiring faulty; PCB faulty.	Cycle is paused.	START/RESET
E43	Door lock unit faulty; Wiring faulty; PCB faulty.	(Safety drain cycle) Cycle stops.	ON/OFF RESET
E44	PCB faulty.	(Safety drain cycle) Cycle stops.	ON/OFF RESET
E45	PCB faulty.	(Safety drain cycle) Cycle stops.	ON/OFF RESET
E51	PCB faulty; current leakage from motor or from wiring.	Cycle blocked, door locked (after 5 attempts).	RESET
E52	Motor faulty; wiring faulty; PCB faulty.	Cycle blocked, door locked (after 5 attempts).	RESET
E53	PCB faulty.	Cycle blocked, door locked.	RESET
E54	PCB faulty; current leakage from motor or from wiring.	Cycle blocked, door locked (after 5 attempts).	RESET

Alarm	Possible fault	Action/machine status	Reset
E57	Motor defective; Wiring defective on inverter for motor, inverter board defective.	Cycle stops with door locked (after 5 attempts).	OFF/reset
E58	Motor defective; Wiring defective on inverter for motor, inverter board defective, abnormal motor operation (motor overloaded).	Cycle stops with door locked (after 5 attempts).	OFF/reset
E59	Motor defective; Wiring defective on inverter for motor; Inverter board defective.	Cycle stops with door locked (after 5 attempts).	OFF/reset
E5A	Inverter board defective. NTC open (on the inverter board). Overheating caused by continuous operation or ambient conditions (let appliance cool down)	Cycle stops with door locked (after 5 attempts).	OFF/reset
E5B	Wiring defective, Inverter board defective	Cycle stops with door locked (after 5 attempts).	OFF/reset
E5C	Inverter board defective, the masters voltage is too high (measure the masters voltage)	Cycle stops with door locked (after 5 attempts).	OFF/reset
E5D	Line interference, Wiring defective, defective main board or inverter board	Cycle stops with door locked (after 5 attempts).	OFF/reset
E5E	Defective wiring between main board and inverter board, Defective inverter board, defective main board.	Cycle stops	OFF
E5F	Defective inverter board, Defective wiring, defective main board	Cycle stops with door locked (after 5 attempts).	OFF/reset
E61	NTC sensor faulty; heating element faulty; wiring faulty; PCB faulty.	The heating phase is skipped.	START/RESET
E62	NTC sensor faulty; heating element faulty; wiring faulty; PCB faulty.	Safety drain cycle – Cycle stopped with door open.	RESET
E66	PCB faulty .	Safety drain cycle – Cycle stopped with door open.	RESET
E68	Earth-leakage between heater and earth.	Cycle blocked with door open.	RESET
E71	Faulty NTC sensor; Wiring faulty; PCB faulty.	Heating is skipped.	START/RESET
E74	NTC sensor improperly positioned; Faulty NTC sensor; Wiring faulty; PCB faulty.	Heating is skipped.	START/RESET
E82	PCB faulty (Wrong configuration data). Selector, wiring	-----	RESET
E83	PCB faulty (Wrong configuration data). Selector, wiring	Cycle cancelled.	START/RESET
E91	Wiring faulty; Faulty control/display board PCB faulty.	-----	RESET
E92	Wrong control/display board; Wrong PCB (do not correspond to the model).	Cycle interrupted.	OFF/ON START
E93	Incorrect configuration data; PCB faulty.	Cycle interrupted.	OFF/ON
E94	Incorrect configuration data; PCB faulty.	Cycle interrupted.	OFF/ON
E95	PCB faulty.	Cycle interrupted.	RESET
E97	Faulty PCB (Wrong configuration data).	Cycle interrupted.	RESET
E98	Incompatibility between main board and Inverter	Cycle interrupted.	OFF/ON
E9B	Display board	Cycle interrupted.	Reset
E9C	Display board	Cycle interrupted.	Reset
E9D	Display board	Cycle interrupted.	Reset
E9F	PCB	Cycle interrupted.	OFF/ON

Alarm	Possible fault	Action/machine status	Reset
EH1	Power supply problems (incorrect / disturbance); PCB faulty.	Wait for frequency nominal conditions.	OFF/ON
EH2	Power supply problems (incorrect / disturbance); PCB faulty.	Wait for voltage nominal conditions.	OFF/ON
EH3	Power supply problems (incorrect / disturbance); PCB faulty.	Wait for voltage nominal conditions.	OFF/ON
EHE	Wiring faulty; PCB faulty.	Safety drain cycle – Cycle stopped with door open.	RESET
EHF	PCB faulty.	Safety drain cycle – Cycle stopped with door open.	RESET
EC1	Solenoid valve faulty/blocked; PCB faulty.	Cycle interrupted with door closed. Drain pump functions always (5 min., then it stops for 5 min. etc.)	RESET
EC3	Wiring faulty; Weight sensor faulty; PCB faulty.	-----	START/RESET
EF1	Drain tube blocked/kinked/too high; Drain filter dirty/blocked.	Warning displayed at the end of cycle (specific LED).	START/RESET
EF2	Excessive detergent dosing; drain tube kinked/blocked; Drain filter dirty/blocked.	Warning displayed after 5 attempts or by the specific LED.	RESET
EF3	Water leaks onto base frame; water control system defective.	Machine drains and cycle stops	OFF/reset
EF4	Tap closed, water pressure too low	-----	Reset
EF5	Final spin phases skipped.	-----	RESET
E00	-----	-----	-----

9.7 Key to circuit diagram

Electrical components on appliance	Components on main board	
<ol style="list-style-type: none"> 1. Analogue pressure switch 2. NTC temperature sensor 3. Solenoid valve for prewash 4. Solenoid valve for wash 5. Thermal cut-out (drain pump) 6. Drain pump 7. Stator (motor) 8. Rotor (motor) 9. Thermal cut-out (motor) 10. Tachometric generator (motor) 11. Interference filter 12. Door lock unit 13. Heating element (with thermal fuses) 14. Motor with half field 15. Motor without half field 16. Electronic board 	<p>DOOR_TY DRAIN_TY K1 K2 K3 K4 MOTOR_TY ON/OFF PWELW_TY WELV_TY</p>	<p>Door interlock Triac Drain pump Triac Heating element relay Motor relay: clockwise rotation Motor relay: anti-clockwise rotation Motor relay: half field power supply (some models) Motor Triac Main switch (programme selector) Pre-wash solenoid Triac Wash solenoid Triac</p>

10 ACCESSIBILITY TO THE ELECTRONIC CONTROL SYSTEM

10.1.1 Work top

- a. Remove the two rear screws, push the top panel towards the rear and release from the cabinet.

10.1.2 Control panel

- b. Press the drawer lock.
- c. Extract.

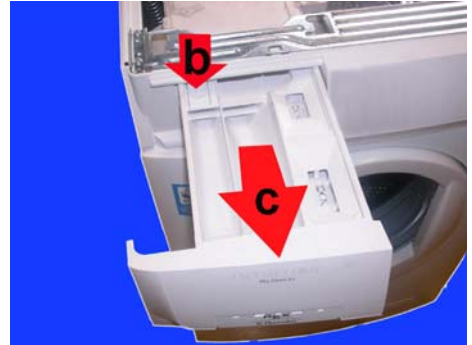

- d. Remove the screw which secures the control panel to the dispenser.



- e. Cut the clamp which secures the wiring to the board casing (while re-assembling, put a new clamp).



- f. Release the wiring from the clamp.
- g. Release the clamp from the cross-member.
- h. Loosen the screws which secure the cross-member to the cabinet.

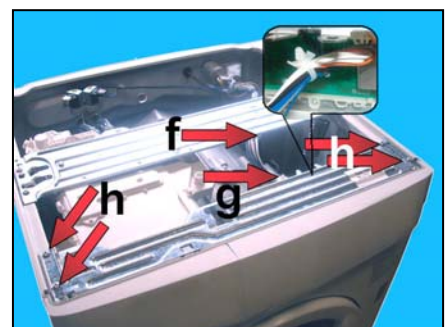

- a. Loosen the screws which secure the control panel to the cross-member.
- b. Release the hook.
- c. Lift the control panel up and extract it.

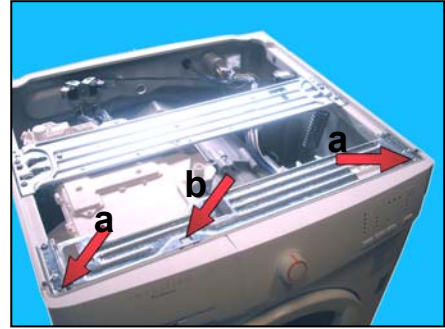

- d. Rotate the control panel.
- e. Detach the connector indicated by the arrow.

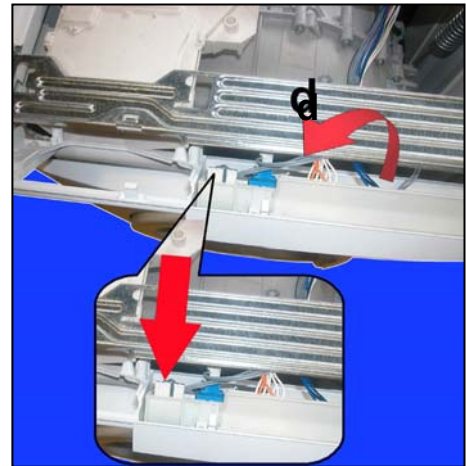

- f. Place the wiring (see fig.).

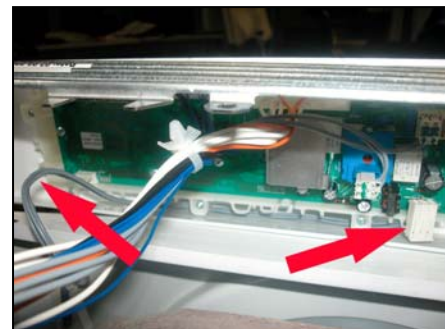

- g. Extract the control panel.



- h. Rotate the control panel around itself.



a. Place it as shown in figure.



b. Remove the screws and release the hooks which secure the board casing to the control panel.

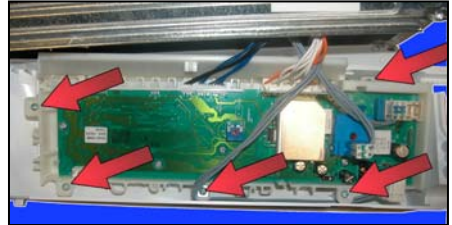

c. Before mounting the new board extract the knob pressing the hooks indicated by the arrows as represented in figure.

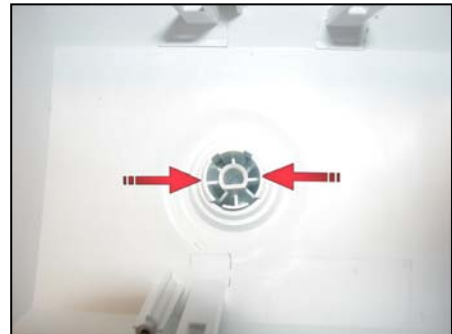

While re-assembling repeat the same operations in reverse order and pay attention to position correctly the knob.



While remounting the work top please pay attention not to position it as in fig. A but as in fig. B.

