



<p>© ELECTROLUX HOME PRODUCTS ITALY S.p.A. Spares Operations Italy Corso Lino Zanussi, 30 I - 33080 PORCIA /PN</p> <p>Fax +39 0434 394096</p> <p>Edition: 2007-02-06</p>	<p>Washing machines with electronic control system ENV06</p> <p>EWM2100 EWM2500</p> <p>Technical and functional characteristics</p> <p>Styling: TC 2 / 3</p> <p>With cabinet</p> <p>ICON</p>	

CONTENTS

1	Purpose of this manual	5
2	PRECAUTIONS	5
2.1	During the delivery	6
2.2	During the reparation	6
3	TC3	7
3.1	GENERAL CHARACTERISTICS	7
3.2	CONTROL PANEL	8
3.2.1	Styling	8
3.2.2	Configuration of control panel	9
3.2.3	Programme selector (S1)	9
3.2.4	Programme configuration	9
3.2.5	Pushbuttons and LEDs	10
3.2.6	Time DRIVEN	11
3.2.7	LCD display	12
4	TC2	14
4.1	GENERAL CHARACTERISTICS	14
4.2	CONTROL PANEL	15
4.2.1	Styling	15
4.2.2	Configuration of control panel	16
4.2.3	Programme selector (S1)	16
4.2.4	Programme configuration	16
4.2.5	Buttons and LCD	17
4.2.6	Time DRIVEN	18
5	DEMO MODE	20
5.1	Exiting DEMO mode	20
6	DIAGNOSTICS SYSTEM	20
6.1	Access to diagnostics mode	20
6.2	Exiting diagnostics mode	20
6.3	Diagnostics phases	21
7	ALARMS	22
7.1	Displaying the alarms to the user	22
7.2	Reading the alarm codes	22
7.2.1	Displaying the alarm	23
7.2.2	Examples of alarm display	23
7.2.3	Operation of alarms during diagnostics	23
7.3	Rapid reading of alarm codes	24
7.4	Cancelling the last alarm	24
8	OPERATING TIME COUNTER	25
8.1.1	Reading of operating time	25
8.1.2	Display of total operating time with LEDs	25
9	WASHING PROGRAMMES AND OPTIONS	26
9.1	Programmes	26
9.2	Options (for appliances EWM 2100 with universal motor)	27
9.3	Options (for appliances EWM2500 with asynchronous motor and inverter)	29
9.3.1	Compatibility between Options	31
9.4	Description of options	32
10	TECHNICAL CHARACTERISTICS	34
10.1	Control system memory	34
10.1.1	General structure of the memory system	34
10.1.2	FLASH	34
10.1.3	RAM	35
10.2	Door interlock	36
10.2.1	Voltmetric interlock with PTC	36
10.2.1.1	Operating principle	36
10.2.2	Instantaneous door interlock	37
10.2.2.1	Operating principle	37
10.2.2.2	Conditions required for opening the door	37
10.2.2.3	Automatic unlock	37
10.3	Water fill system	38
10.4	Analogue pressure switch of water level control in the tub	38
10.5	Drain pump	39
10.6	Recirculation pump (if featured)	39
10.7	Heating	40
10.8	Temperature sensor	40

10.9	Universal motor (EWM 2100).....	41
10.9.1	Power supply to motor.....	41
10.10	Three-phase asynchronous motor (EWM2500).....	41
10.10.1	Power supply to motor.....	41
10.11	Anti-foam control system.....	42
10.12	“FUCS” (Fast Unbalance Control System).....	43
10.13	Table of alarm codes.....	45
10.14	Diagram with UNIVERSAL MOTOR EWM2100.....	48
10.15	Diagram with THREE-PHASE ASYNCHRONOUS MOTOR EWM2500.....	50
11	ACCESSIBILITY.....	52
11.1	To the electronic control system.....	52
11.1.1	Work top.....	52
11.1.2	Control panel.....	52
11.2	Door interlock.....	54
11.3	New drain filter.....	55
11.4	Inverter board.....	56

1 Purpose of this manual

The purpose of this manual is to provide service engineers who are already familiar with the repair procedures for traditional washing machines with information regarding appliances fitted with the ENV06 electronic control system and produced in Porcia (Italy).

The characteristic of the ENV06 electronic control system is to use only an electronic pressure switch to check the various water levels in the tub (with the elimination of the mechanical pressure switches: anti-overflow, anti-boiling, 1st-2nd level), and a new heater with two thermal fuses which interrupt if the temperature degree overcomes the values by which they are calibrated.

The following are described:

- general characteristics
- control panel and washing programmes
- technical and functional characteristics
- access to the electronic control system

For detailed information concerning hydraulic circuit, structural characteristics of the appliances and accessibility, please refer to Service Manual:

- *Publication no. 599 37 47-13 – washing machines with HEC cabinet.*

Identification table between styling (TC2/3) and functionality (EWM 2100/2500)

Styling	EWM 2100		EWM 2500	
	Washing type	Motor	Washing type	Motor
TC2	<ul style="list-style-type: none"> •Traditional with ECO-BALL •Jet-System 	Universal	<ul style="list-style-type: none"> •Traditional with ECO-BALL •Jet-System 	Three-phase asynchronous with Inverter
TC3	<ul style="list-style-type: none"> •Traditional with ECO-BALL •Jet-System 	Universal	<ul style="list-style-type: none"> •Traditional with ECO-BALL •Jet-System 	Three-phase asynchronous with Inverter

2 PRECAUTIONS



- **Electrical appliances must be serviced only by qualified Service Engineers.**
- **Always remove the plug from the power socket before touching internal components.**
- **In case of replacement of the heater, replace it with one with the same characteristics in order not to compromise the safety of the appliance.**
- **Before laying down the appliance, always drain the water through the appropriate system placed near the drain filter.**
- **Do not lay down the appliance on the right side (electronic control side): some water could come out from the detergent drawer that would deposit on the electrical components with possible burnings.**

2.1 During the delivery

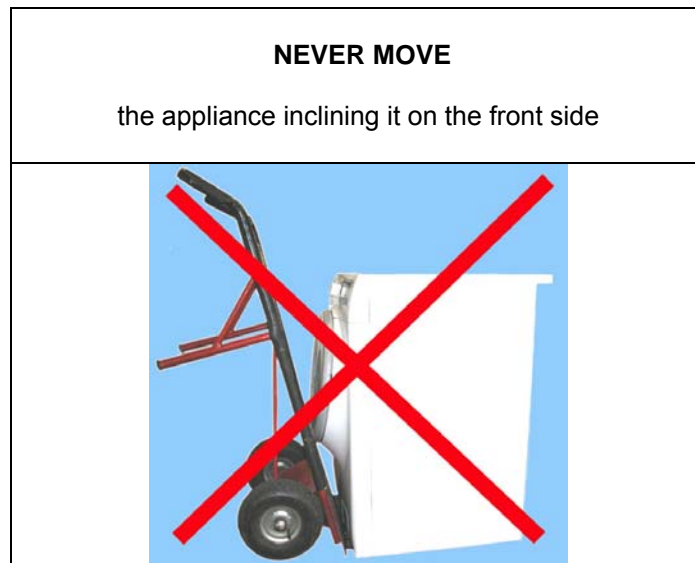

2.2 During the reparation

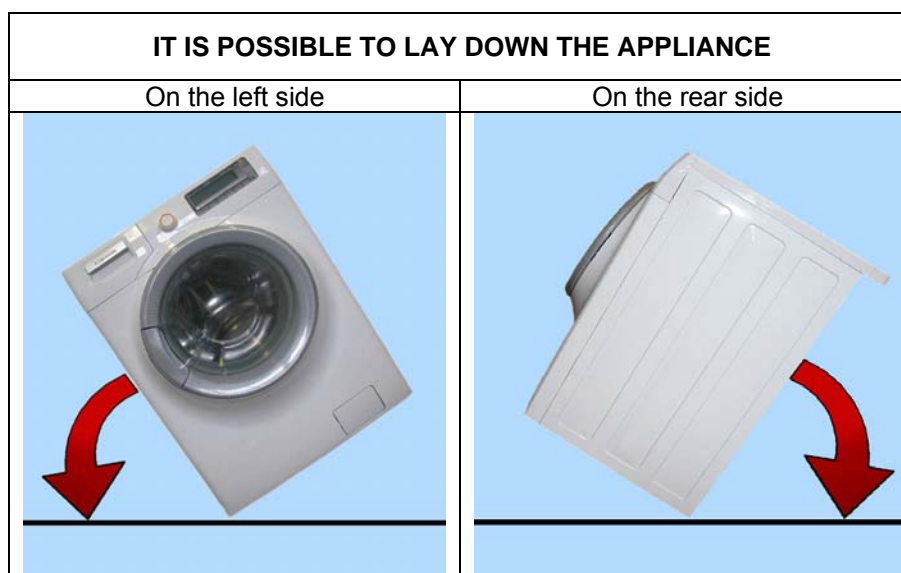
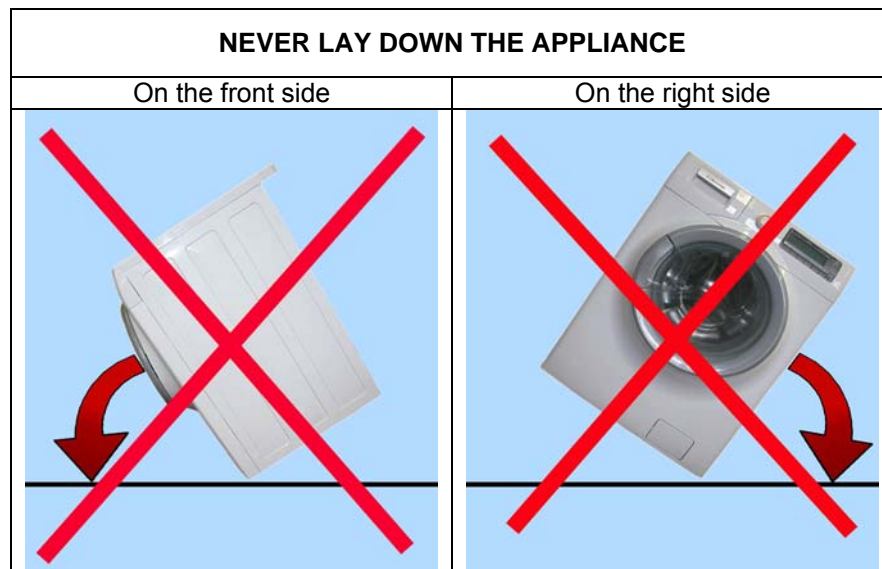

3 TC3

3.1 GENERAL CHARACTERISTICS

The ENV060 electronic control system consists of a single PCB, which incorporates the power, control and display (where the LCD display is connected) functions and the programme selector is incorporated in the board.

The PCB is mounted on a casing fitted to the control panel.

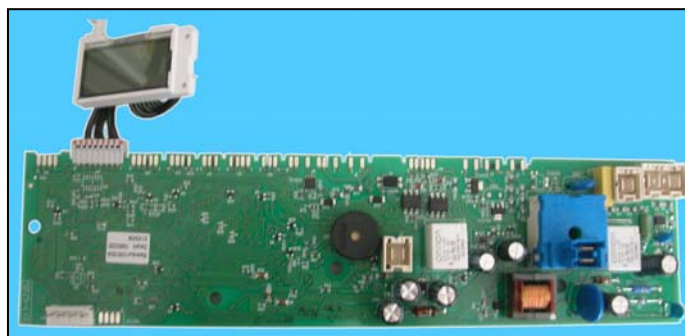

Version TC3	
Number of buttons	<ul style="list-style-type: none"> ▪ Max. 8 (5 options + 1 start/pause + 2 for time driven)
Number of LEDs	<ul style="list-style-type: none"> ▪ Max. 18 + LCD display
Programme selector	<ul style="list-style-type: none"> ▪ 15-21 positions with main switch (incorporated in the PCB)
Serial port	<ul style="list-style-type: none"> ▪ DAAS-EAP communications protocol up to 115.200 baud
Power supply	<ul style="list-style-type: none"> ▪ 220/240V ▪ 50/60 Hz (configurable)
Type of washing	<ul style="list-style-type: none"> ▪ Traditional with “eco-ball” sphere ▪ Jet-system
Rinsing system	<ul style="list-style-type: none"> ▪ Traditional with “eco-ball” sphere ▪ Jet-system
Motor	<ul style="list-style-type: none"> ▪ Collector, with tachometric generator (Universal) ▪ Two-pole asynchronous, with three-phase tachometric generator (with Inverter)
Spin speed	<ul style="list-style-type: none"> ▪ 600 ÷ 1600 rpm
Anti-unbalancing system	<ul style="list-style-type: none"> ▪ FUCS
Water fill	<ul style="list-style-type: none"> ▪ 1 solenoid valve with 1 inlet – 2/3 outlets
Detergent drawer	<ul style="list-style-type: none"> ▪ 3 compartments: prewash/stains, wash, conditioners ▪ 4 compartments: prewash/stains, wash, conditioners, bleach
Control of water level in the tub	<ul style="list-style-type: none"> ▪ Electronic/analogue pressure switch
Door safety device	<ul style="list-style-type: none"> ▪ Traditional (with PTC) ▪ Instantaneous
Power of heating element	<ul style="list-style-type: none"> ▪ 1950W with thermal fuse incorporated
Temperature control	<ul style="list-style-type: none"> ▪ NTC sensor incorporated in the heater
Buzzer	<ul style="list-style-type: none"> ▪ Traditional incorporated in the electronic board
Sensors	<ul style="list-style-type: none"> ▪ Water fill gauge (flowmeter) ▪ Aqua control

3.2 CONTROL PANEL

3.2.1 Styling

- max. 8 buttons
- 15 or 21-position programme selector
- 18 LEDs
- LCD display



- Disposition of LEDs and buttons

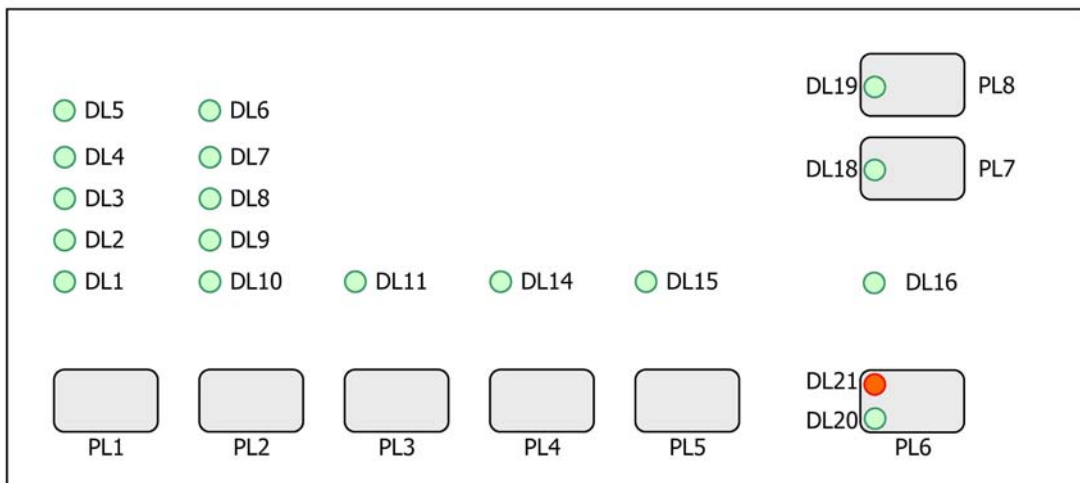

3.2.2 Configuration of control panel

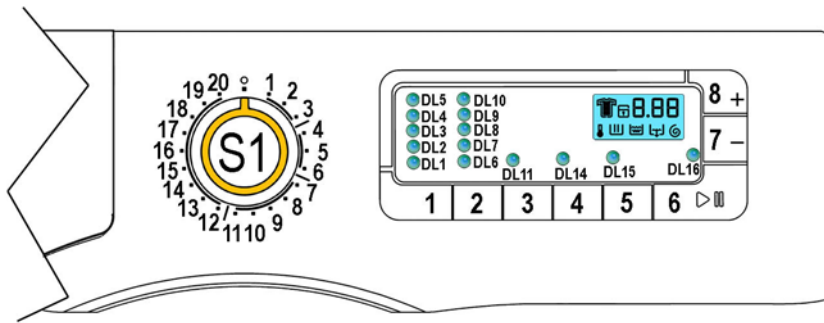

The washing programmes, the functions of the selector knob and the various pushbuttons vary according to the model, since these are determined by the configuration of the appliance.

3.2.3 Programme selector (S1)

The selector features 15-21 positions and incorporates the ON/OFF switch. The various positions of the selector may be configured to perform different washing programmes (ex: water level, drum movement, no. of rinses and the washing temperature to be selected according to the type of clothes) and can be turned both clockwise and anti-clockwise.

In the first position, the appliance is switched off and the current programme is cancelled.

For each programme, the compatible options and other parameters are defined.



3.2.4 Programme configuration

The table below lists the parameters that can be used to define the washing programmes.

Types of fabric	Cotton/linen, Synthetic fabrics, Delicates, Wool, Hand-wash, Shoes, Jeans, Duvet, Silk.
Special programmes	Soak, Miniprogramme, Easy-Iron, Conditioner, Rinses, Delicate rinses, Drain, Delicate spin, Spin.
Temperature	Normal, Maximum: the initial temperature is the maximum that can be selected for a specific washing programme.
Spin	Normal, Minimum, Maximum.
Options (Normal / Possible)	Rinse Hold, Night-time cycle, Pre-wash, Stains, Bleach, Economy (energy label), Extra rinse, Half-load, Easy-Iron, Reduced spin speed, No spin, Intensive, Normal, Daily, Light, Short, Very short.
Programme phases	Pre-wash, Wash, Rinses, Spin, Delayed start.

3.2.5 Pushbuttons and LEDs

The functions of each button are defined by the configuration of the appliance.

- Button no. 1:** this button is configurable and is related to LEDs (DL1÷DL5).
 Depending on the configuration of the appliance it can be connected both to the temperature regulation and the spin speed regulation. Pressing it in sequence, you can choose the different regulation. Depending on the configuration of the appliance it is possible to have different combinations. The following tables represent some examples of combinations between temperature and spin.



LEDs	Temperature	
DL5	90°	90°
DL4	60°	60°
DL3	40°	50°
DL2	30°	40°
DL1	0°	30°

LEDs	Spin	
DL5	1200	1400
DL4	900	900
DL3	700	700
DL2	Night cycle	Night cycle
DL1	Rinse hold	Rinse hold

- Button no. 2:** this button is configurable and is related to LEDs (DL6÷DL10).
 The description of the functions is the same as the one of button 1.

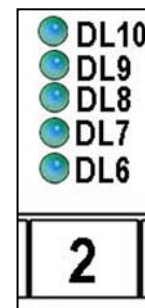

- Button no. 3:** this button is configurable and is related to LED (DL11).
 Depending on the configuration of the appliance it can perform the function of:
 Normal, daily, light, quick, super quick, intensive, economy, prewash, easy-iron, bleach, stains, super rinse, night cycle, rinse hold, half load, spin reduction, no spin.
- Button no. 4:** this button is configurable and is related to LED (DL14).
 Depending on the configuration of the appliance it can perform the function of:
 Normal, daily, light, quick, super quick, intensive, economy, prewash, easy-iron, bleach, stains, super rinse, night cycle, rinse hold, half load, spin reduction, no spin.
- Button no. 5:** this button is configurable and is related to LED (DL15).
 Depending on the configuration of the appliance it can perform the function of:
 Normal, daily, light, quick, super quick, intensive, economy, prewash, easy-iron, bleach, stains, super rinse, night cycle, rinse hold, half load, spin reduction, no spin.
 It can also perform the function of delayed start.
- Button no. 6:** this button is configurable and has the function of START/PAUSE (inside there are two LEDs, one red that flashes in case of an alarm and one green that flashes when the appliance is in pause mode or in combination with the red one to indicate the alarm code).

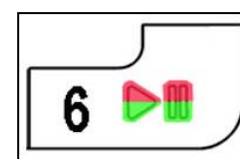
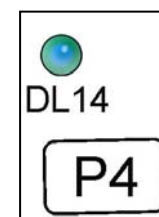
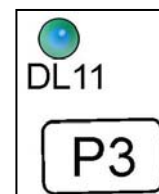

- **DL16 Door closed:** It lights up when the safety device stops the door opening and switches off when it is possible to open it. It flashes when the device is about to unlock the door (with door interlock with PTC, which need one or two minutes to open).



3.2.6 Time DRIVEN

The “Time driven” has the function to modify the programme setting, according to the type of dirt so as to obtain a reduction or an increase of the washing time, displaying the dirt level through an icon, represented by a t-shirt and the time through the three digits positioned on the right of the LCD display. This variation can be modified through two buttons P8 and P7 positioned besides the display. The symbol remains lit for the whole duration of the programme.

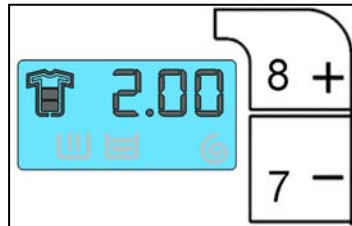

Please find below the various levels combined with the dirt degree.

- ↩ Super quick (super rapid cycle) indicated for cottons and synthetics with light dirt level, and for half load.

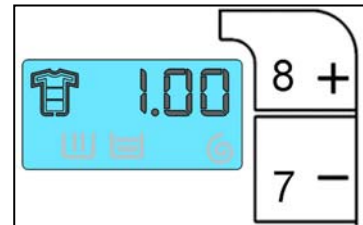

- ↩ Quick cycle indicated for clothes used just once.

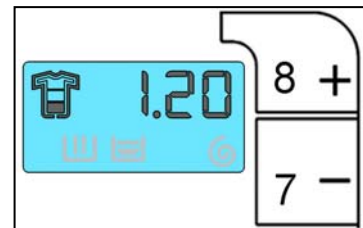

- ↩ Light cycle indicated to clothes slightly dirty or of daily use.

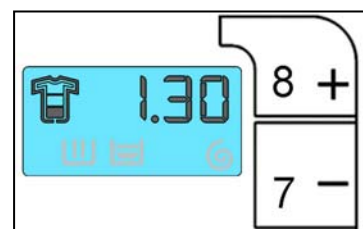

- ↩ Daily cycle indicated for quite dirty clothes.

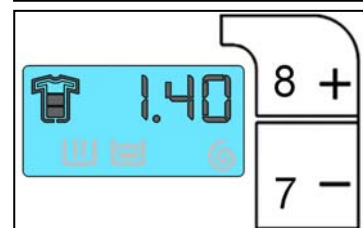

- ↩ Normal cycle indicated for quite dirty clothes worn many times.

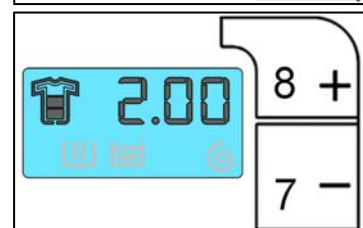

- ↵ Intensive cycle indicated for very dirty clothes which needs anti-stain treatments, soak and prewash.

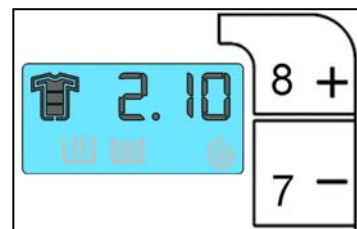

The levels are represented in the following table:

COTTONS	SYNTHETICS	DELICATES
INTENSIVE	-----	-----
NORMAL (basic programme)	NORMAL (basic programme)	NORMAL (basic programme)
DAILY	DAILY	DAILY
LIGHT	LIGHT	LIGHT
QUICK	-----	-----
SUPER QUICK	SUPER QUICK	SUPER QUICK

3.2.7 LCD display

The LCD display shows the following information:

The three digits with seven segments represent:

- ↵ - **The duration of the washing programme**, which appears after having selected it. This time corresponds to that necessary for the maximum wash load for each programme type. After starting the programme the time decreases minute by minute.



- ↵ - **The end of the programme** is indicated by **three zero flashing** (when it is possible to open the door).



- ↵ - **The stop of the appliance with water in tub**, after the programmes with RINSE HOLD option, is displayed by **three zero flashing**. The LED that indicates the door remains lit and the LED of the START/PAUSE button switches off.

- ↵ - **The delayed start**, selected through the relative button. After pressing the START/PAUSE button the countdown starts and the delay time decreases hour by hour. In the last 2 hours it diminishes by 30 min.



- ↵ - **The thermometer**: it is always on during the cycle and the icon is animate during the heating phase.



- ↵ - **The padlock**: when is on, it indicates that all the buttons are disabled to prevent the children from modifying, starting or pausing the cycle. To disable this function it is necessary to push a key combination (See User Manual).

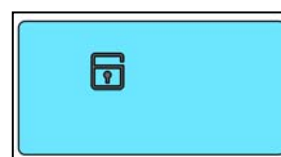

↩ - **Washing phases:** wash, rinses, drain and spin light up in the selection mode if the programme includes these phases and during the execution of the phase.

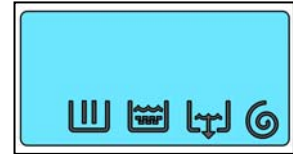

↩ - **Wrong choice of an option** is displayed by Err, when a function not compatible with the chosen programme is selected. The wrong selection is also signalled by an acoustic alarm.

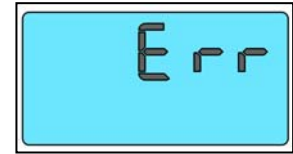

↩ - **An alarm code**, indicates an error of the appliance operation. Simultaneously to the displaying of the code, the START/PAUSE flashes.

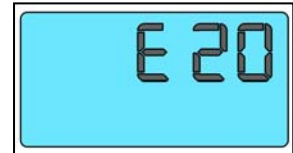

- **Buzzer**

The buzzer emits:

- A “**beep**” when the programmes are selected, an option, when the START/PAUSE button is pressed to start or pause the cycle.
- Three “**beeps**” when an option not compatible with the selected programme is chosen, or when a button is pressed or the knob turned during a cycle.
- A particular sequence of “**beeps**” for a two-minute duration when the cycle has terminated.
- A particular sequence of three “**beeps**”, to signal a malfunctioning of the appliance.

4 TC2

4.1 GENERAL CHARACTERISTICS

The ENV060 electronic control system consists of a single PCB, which incorporates the power, control and display (where the LCD display is connected) functions and the programme selector is incorporated in the board.

The PCB is mounted on a casing fitted to the control panel.



Version TC2	
Number of buttons	<ul style="list-style-type: none"> ▪ Max. 8 (5 options + 1 start/pause + 2 for time driven)
Number of LEDs	<ul style="list-style-type: none"> ▪ Max. 2 + LCD display
Programme selector	<ul style="list-style-type: none"> ▪ 15-21 positions with main switch (incorporated in the PCB)
Serial port	<ul style="list-style-type: none"> ▪ DAAS-EAP communications protocol up to 115.200 baud
Power supply	<ul style="list-style-type: none"> ▪ 220/240V ▪ 50/60 Hz (configurable)
Type of washing	<ul style="list-style-type: none"> ▪ Traditional with “eco-ball” sphere ▪ Jet-system
Rinsing system	<ul style="list-style-type: none"> ▪ Traditional with “eco-ball” sphere ▪ Jet-system
Motor	<ul style="list-style-type: none"> ▪ Collector, with tachometric generator (Universal) ▪ Two-pole asynchronous, with three-phase tachometric generator (with Inverter)
Spin speed	<ul style="list-style-type: none"> ▪ 600 ÷ 1600 rpm
Anti-unbalancing system	<ul style="list-style-type: none"> ▪ FUCS
Water fill	<ul style="list-style-type: none"> ▪ 1 solenoid valve with 1 inlet – 2/3 outlets
Detergent drawer	<ul style="list-style-type: none"> ▪ 3 compartments: prewash/stains, wash, conditioners ▪ 4 compartments: prewash/stains, wash, conditioners, bleach
Control of water level in the tub	<ul style="list-style-type: none"> ▪ Electronic/analogue pressure switch
Door safety device	<ul style="list-style-type: none"> ▪ Traditional (with PTC) ▪ Instantaneous
Power of heating element	<ul style="list-style-type: none"> ▪ 1950W with thermal fuse incorporated
Temperature control	<ul style="list-style-type: none"> ▪ NTC sensor incorporated in the heater
Buzzer	<ul style="list-style-type: none"> ▪ Traditional incorporated in the electronic board
Sensors	<ul style="list-style-type: none"> ▪ Water fill gauge (flowmeter) ▪ Aqua control

4.2 CONTROL PANEL

4.2.1 Styling

- max. 8 buttons
- 15 or 21-position programme selector
- 2 LEDs
- LCD display

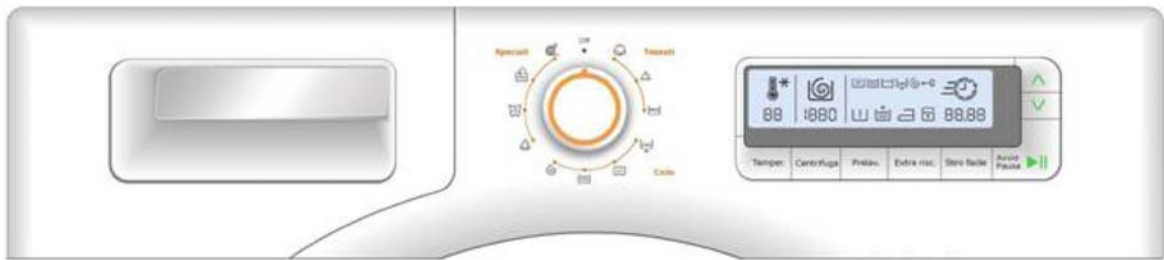

- Disposition of LEDs and buttons

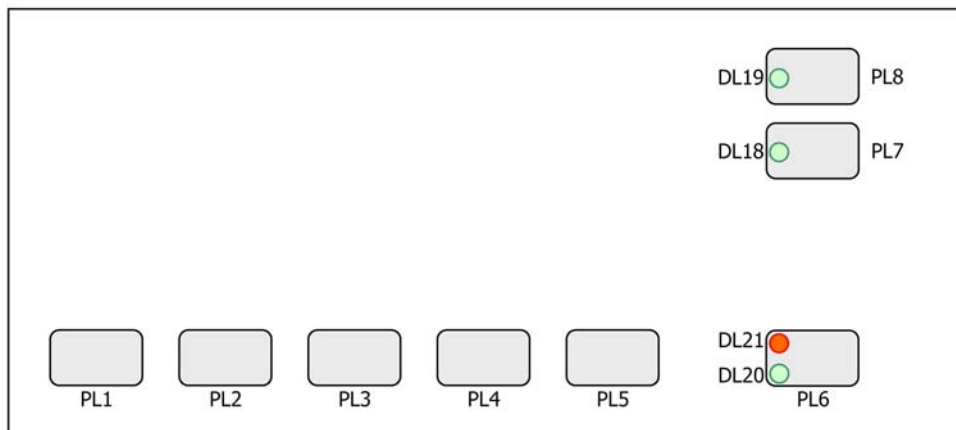

4.2.2 Configuration of control panel

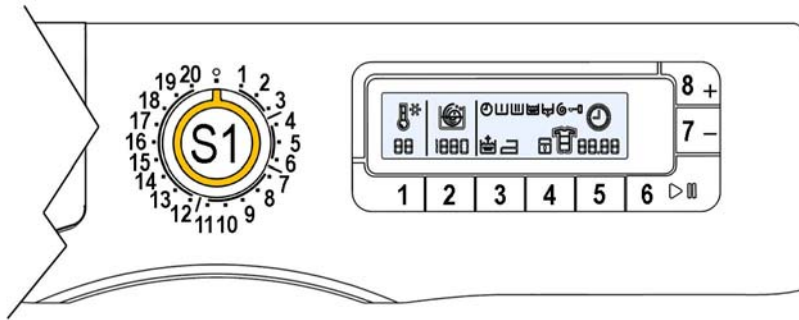

The washing programmes, the functions of the selector knob and the various pushbuttons vary according to the model, since these are determined by the configuration of the appliance.

4.2.3 Programme selector (S1)

The selector features 15-21 positions and incorporates the ON/OFF switch. The various positions of the selector may be configured to perform different washing programmes (ex: water level, drum movement, no. of rinses and the washing temperature to be selected according to the type of clothes) and can be turned both clockwise and anti-clockwise.

In the first position, the appliance is switched off and the current programme is cancelled.

For each programme, the compatible options and other parameters are defined.



4.2.4 Programme configuration

The table below lists the parameters that can be used to define the washing programmes.

Types of fabric	Cotton/linen, Synthetic fabrics, Delicates, Wool, Hand-wash, Shoes, Jeans, Duvet, Silk.
Special programmes	Soak, Miniprogramme, Easy-Iron, Conditioner, Rinses, Delicate rinses, Drain, Delicate spin, Spin.
Temperature	Normal, Maximum: the initial temperature is the maximum that can be selected for a specific washing programme.
Spin	Normal, Minimum, Maximum.
Options (Normal / Possible)	Rinse Hold, Night-time cycle, Pre-wash, Stains, Bleach, Economy (energy label), Extra rinse, Half-load, Easy-Iron, Reduced spin speed, No spin, Intensive, Normal, Daily, Light, Short, Very short.
Programme phases	Pre-wash, Wash, Rinses, Spin, Delayed start.

4.2.5 Buttons and LCD

The functions of each button are defined by the configuration of the appliance.

- **Button no. 1: TEMPERATURE**

The temperature set by the programme is the base one, pressing the button it is possible to modify it from a max. to a minimum depending on the programme. Simultaneously the thermometer symbol is modified.



- **Button no. 2: SPIN**

The spin set by the programme is the maximum one, pressing the button it is possible to vary the speed up to zero, then it passes to NIGHT CYCLE and RINSE HOLD (with relative lighted symbols).

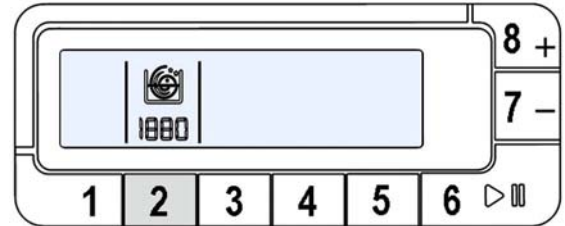

- **Button no. 3: OPTIONS**

Configurable button. The options available for this button are:

- Pre-wash (it can be configured also as programme)
- Easy-iron (it can be configured also as programme)
- Intensive



- **Button no. 4: OPTIONS**

Configurable button. The options available for this button are:

- Super rinse
- Quick

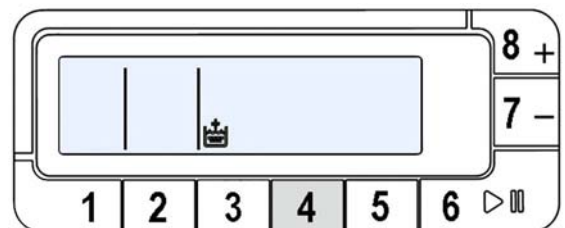

- **Button no. 5: DELAYED START/ SUPER RINSE**

Configurable button. It can perform the function of:

- Delayed start
- Super rinse

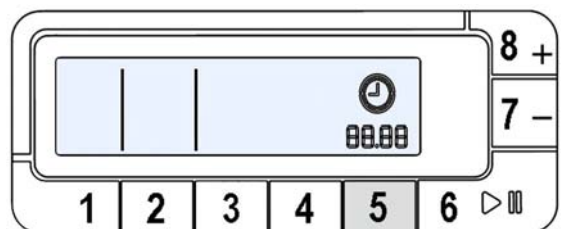

- **Button no. 6: START/PAUSE**

This button is configurable and has the function of START/PAUSE (inside there are two LEDs, one red that flashes in case of alarm and one green that flashes when the appliance is in pause mode or in combination with the red one to indicate the alarm code).

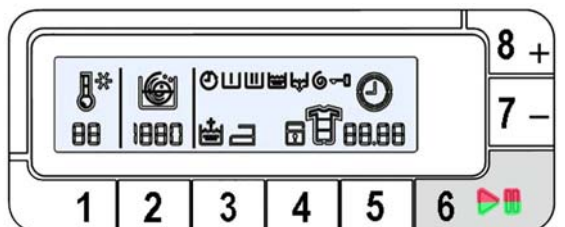

4.2.6 Time DRIVEN

The “Time driven” has the function to modify the programme setting, according to the type of dirt so as to obtain a reduction or an increase of the washing time, displaying the dirt level through an icon, represented by a t-shirt and the time through the three digits positioned on the right of the LCD display. This variation can be modified through two buttons P8 and P7 positioned besides the display. The symbol remains lit for the whole duration of the programme.

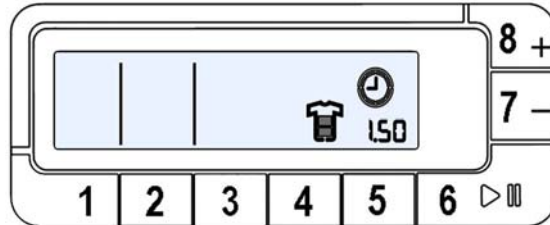

Please find below the various levels combined with the dirt degree.

↩ Super quick (super rapid cycle) indicated for cottons and synthetics with light dirt level, and for half load.

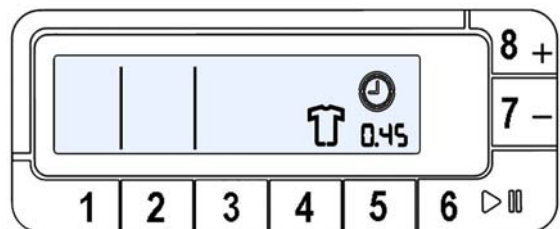

↩ Quick cycle indicated for clothes used just once.

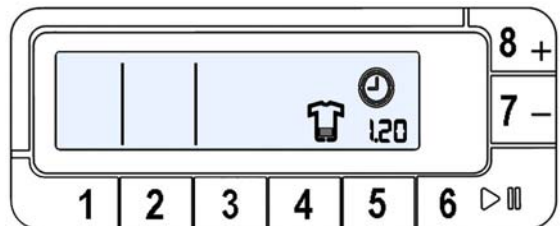

↩ Light cycle indicated to clothes slightly dirty or of daily use.

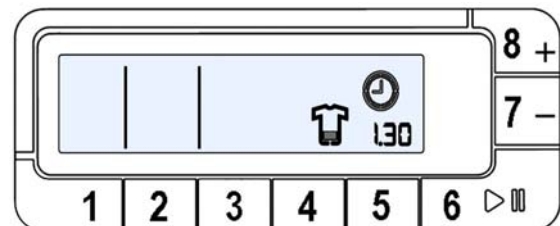

↩ Daily cycle indicated for quite dirty clothes.

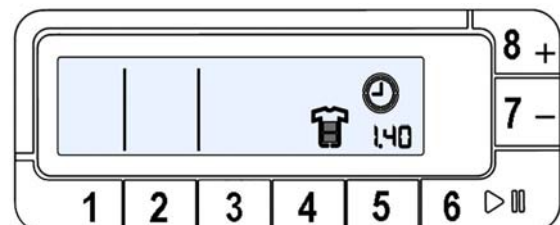

↩ Normal cycle indicated for quite dirty clothes worn many times.

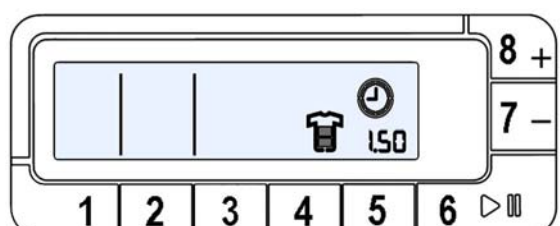

↩ Intensive cycle indicated for very dirty clothes which need anti-stain treatments, soak and prewash.

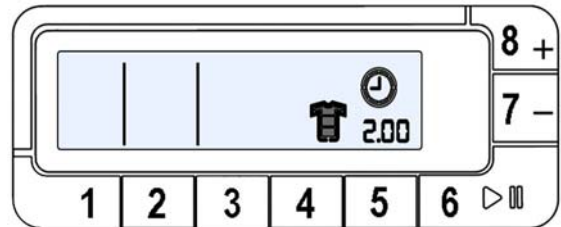

The levels are represented in the following table:

COTTONS	SYNTHETICS	DELICATES
INTENSIVE	-----	-----
NORMAL (basic programme)	NORMAL (basic programme)	NORMAL (basic programme)
DAILY	DAILY	DAILY
LIGHT	LIGHT	LIGHT
QUICK	-----	-----
SUPER QUICK	SUPER QUICK	SUPER QUICK

↩ Padlock
See page 12.

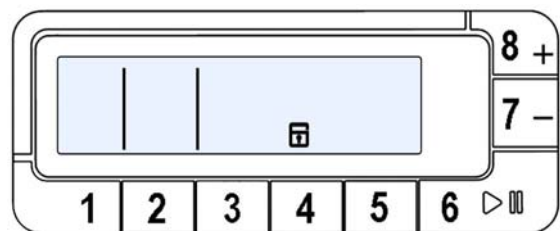

↩ Washing phases

Pre-wash, wash, rinses, drain and spin light up in selection mode if the programme includes these phases and during the execution of the phase.
Pre-wash lights up when it is configured as option and selected with the relative button.

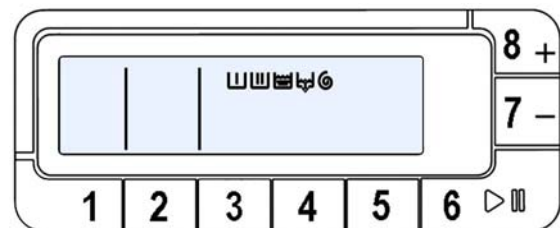

↩ Door lock

It lights up when the door is locked.
It switches off when the door is not locked.
It flashes when the door is about to unlock (above all in models with door interlock with PTC).

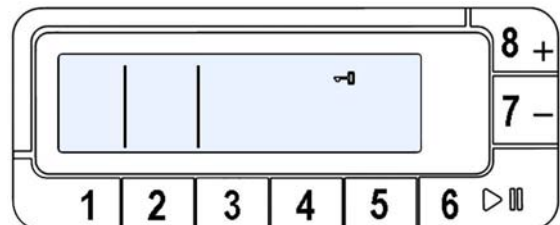

↩ Duration of the cycle

Displaying of the time to end of the selected programme.

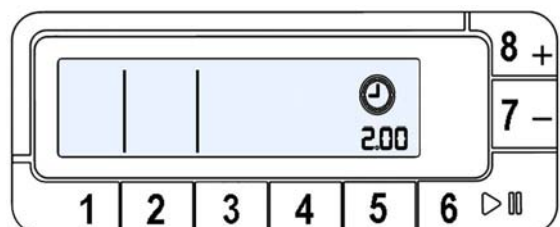

- Buzzer
See page 13.

5 DEMO MODE

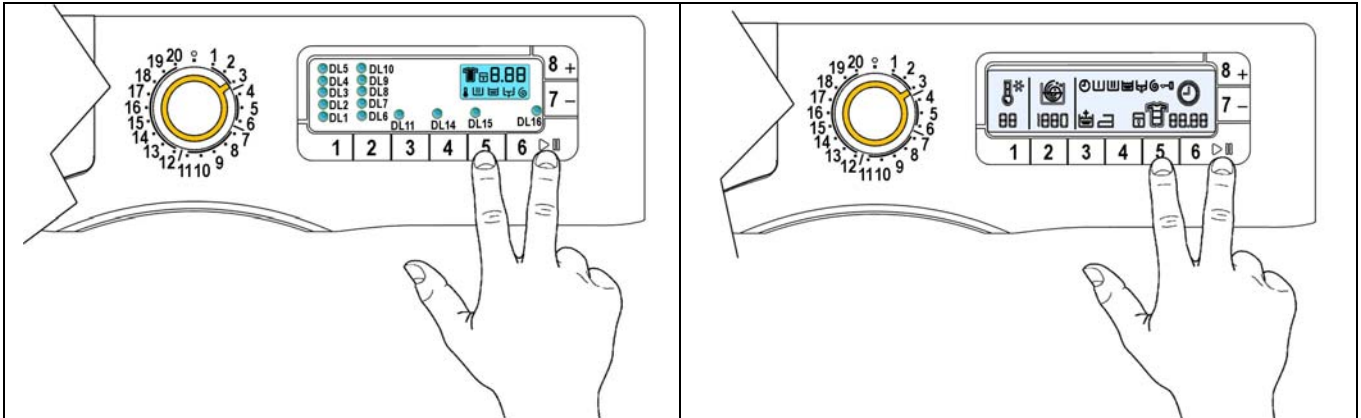

1. Switch off the appliance.
1. Press and hold down **START/PAUSE** button and the nearest **option button** simultaneously (as represented in figure).
2. Holding down both buttons, switch the appliance on by turning the programme selector by **three positions clockwise**.
3. Hold the buttons down till “dEM” flashes for a short time.

5.1 Exiting DEMO mode

To exit the demo cycle, switch the appliance off (programme selector in off/cancel position).

6 DIAGNOSTICS SYSTEM

6.1 Access to diagnostics mode

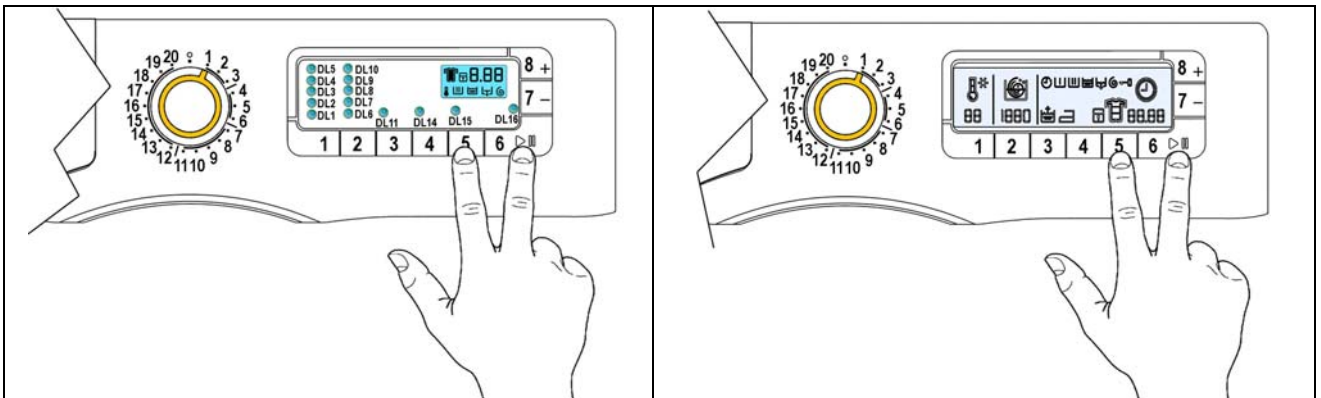



1. Switch off the appliance.
2. Press and hold down **START/PAUSE** button and the nearest **option button** (as represented in figure).
3. Holding down both buttons, switch the appliance on by turning the programme selector by **one position clockwise**.
4. Continue to hold down the buttons till the LEDs and the symbols begin to flash (at least 2 seconds). In the first position, the operation of the buttons and the relative LEDs is checked; turning the selector knob **clockwise** the diagnostics cycle for the operation of the various components and the alarm reading is activated.

6.2 Exiting diagnostics mode

→ To exit the diagnostics cycle, switch the appliance off, then on, and then off again.

6.3 Diagnostics phases

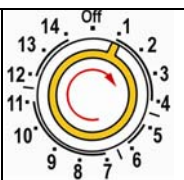
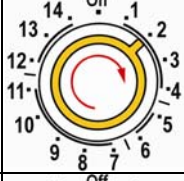
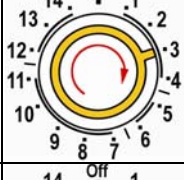
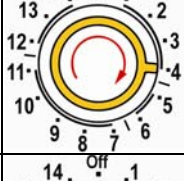
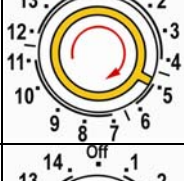
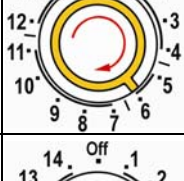
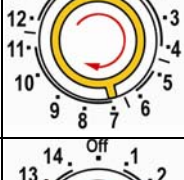
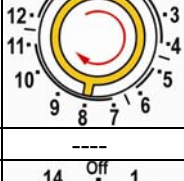
Irrespective of the type of PCB and the configuration of the programme selector it is possible, after entering diagnostics mode, to perform diagnostics on the operation of the various components and to read the alarms by turning the programme selector **clockwise**. All the alarms are enabled during the diagnostics cycle.

Selector position	Components actioned	Operating conditions	Function checked	Display
1	 <ul style="list-style-type: none"> - All the LEDs and symbols light in sequence. - When a button is pressed, the corresponding LED or symbol light. 	Always activated	Operation of the user interface	
2	 <ul style="list-style-type: none"> - Door interlock - Wash solenoid 	Door locked Water level below anti-flooding level Maximum time 5 minutes	Water ducted through washing compartment	Displays the water level in tub
3	 <ul style="list-style-type: none"> - Door interlock - Pre-wash solenoid 	Door locked Water level below anti-flooding level Maximum time 5 minutes	Water ducted through pre-wash compartment (bleach)	Displays the water level in tub
4	 <ul style="list-style-type: none"> - Door interlock - Pre-wash and wash solenoids 	Door locked Water level below anti-flooding level Maximum time 5 minutes	Water ducted through conditioner compartment	Displays the water level in tub
5	 <ul style="list-style-type: none"> - Door interlock - Bleach/stains solenoids 	Door locked Water level below anti-flooding level Maximum time 5 minutes	Water ducted through conditioner/stains compartments	Displays the water level in tub
6	 <ul style="list-style-type: none"> - Door interlock - Wash solenoid if the level of water in the tub does not cover the heater - Heating element - Recirculation pump 	Door locked Water level above the heater Maximum time 10 minutes or up to 90°C (*)	Heating Recirculation	Wash water temperature
7	 <ul style="list-style-type: none"> - Door interlock - Wash solenoid if the level of water in the tub does not cover the heater - Motor (55 rpm clockwise, 55 rpm counter-clockwise, 250 rpm impulse) 	Door locked Water level above the heater	Check for leaks from the tub	Displays the drum speed (the real value divided by ten)
8	 <ul style="list-style-type: none"> - Door interlock - Drain pump - Motor up to 650 rpm then at maximum spin speed 	Door locked Water level lower than anti-boiling level for spinning	Drain and spin; control of congruence in closure of level pressure switches	Displays the drum speed (the real value divided by ten)
9	----	----	----	
10	 <ul style="list-style-type: none"> - Reading/Cancellation of the last alarm 	----	----	

(*) In most cases, this time is sufficient to check the heating. However, the time can be increased by repeating the phase without draining the water: pass for a moment to a different phase of the diagnostics cycle and then back to the heating control phase (if the temperature is higher than 80°C, heating does not take place).

(**) The check at the maximum speed occurs without control of the FUCS and no clothes have to be inserted inside the appliance.

7 ALARMS

7.1 Displaying the alarms to the user

The alarms are displayed by the red LED of the START/PAUSE button flashing and simultaneously through the LCD or Display.

The alarms displayed to the user are listed below:

- ↔ E10 - Water fill difficulty (closed tap)
- ↔ E20 - Drain difficulty (dirty filter)
- ↔ E40 - Door open

They are represented through the flashing of the red LED inside the START-PAUSE and can be solved directly by the user.

The alarms listed below, instead:

- ↔ EF0 – Water leakage (Aqua Control System)
- ↔ EH0 – Voltage or frequency out of the normal values

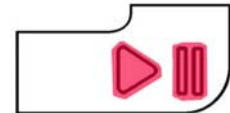

are displayed to the user, but for their solution it is necessary the intervention of the Service.

The alarms are enabled during the execution of the washing programme, with the exception of alarms associated with configuration and the power supply (voltage/frequency), which are also displayed during the programme selection phase.

The door can normally be opened (except where specified) when an alarm condition has occurred on condition that:

- The level of the water in the tub is below a certain level
- Water temperature lower than 55°C
- Motor stopped

Certain alarm conditions require that a drain phase be performed before the door can be opened for safety reasons:

- Cooling water fill if the temperature is higher than 65°C
- Drain until the analogue pressure switch is on empty, during a max. 3-minute time.

7.2 Reading the alarm codes

It is possible to display the last three memorised alarms in the FLASH memory of the electronic board:

- Enter diagnostics mode (par. 7.1).
- Irrespective of the type of PCB and configuration, turn the programme selector **clockwise** to the **tenth position**.
- The last alarm is displayed.
- To display the previous alarms, press sequentially the left button of the START/PAUSE button (as represented in figure).

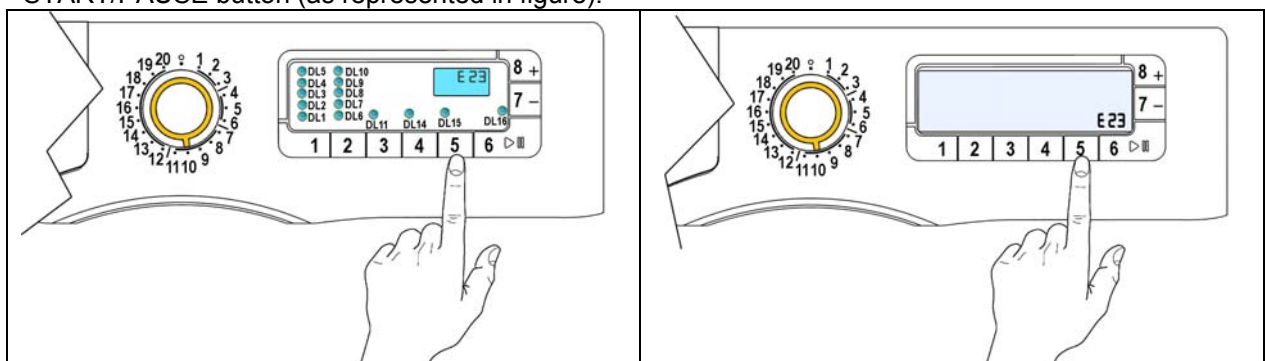
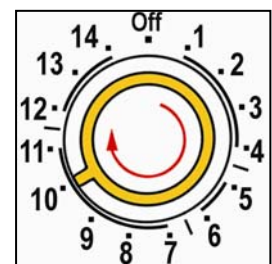

- To return to the last alarm press the START/PAUSE button.

7.2.1 Displaying the alarm

The alarm is displayed by a repeated flashing sequence of the START / PAUSE button with red and green light (0,5 seconds on, 0,5 seconds off with a 2,5 second pause between the sequences).

- button indicator START / PAUSE with red light → indicates the first digit of the alarm code (family)
- button indicator START / PAUSE with green light → indicates the second digit of the alarm code (internal number of the family)

These two LEDs are featured in all models.

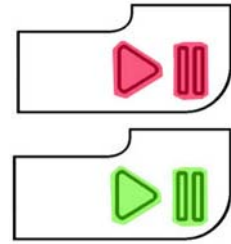

Notes:

- The first letter of the alarm code "E" (Error) is not displayed, since this letter is common to all alarm codes.
- The alarm code "families" are shown in hexadecimal; in other words:
 - **A** is represented by **10** flashes
 - **B** is represented by **11** flashes
 - ...
 - **F** is represented by **15** flashes
- Configuration errors are shown by the flashing of all the LEDs (user interface not configured).

7.2.2 Examples of alarm display

Example: Alarm E43 (problems with the door interlock Triac) will display the following:

- the sequence of four flashes of the START / PAUSE button with red light, indicates the first number **E43**;
- the sequence of three flashes of the START / PAUSE button with green light, indicates the second number **E43**;

START / PAUSE button with red light			START / PAUSE button with green light		
ON / OFF	Time (Sec.)	ON / OFF	Time (Sec.)	ON / OFF	Time (Sec.)
	0.5	1		0.5	1
	0.5			0.5	
	0.5	2		0.5	2
	0.5			0.5	
	0.5	3		0.5	3
	0.5			0.5	
	0.5	4		2.5	Pause
	0.5				
	1.5	Pause			

7.2.3 Operation of alarms during diagnostics

All alarms are enabled during the components diagnostics phase.

7.3 Rapid reading of alarm codes

The last three alarm codes can be displayed even if the programme selector is not in the tenth position (diagnostics) or if the appliance is in normal operating mode (e.g. during the execution of the washing programme):

- Press and hold down **START/PAUSE** and the nearest **option button** (as to enter the DIAGNOSTICS), for at least two seconds: the LEDs initially switch off, and then display the flashing sequence indicating the last alarm.
- To display the previous alarms press the left button of the START/PAUSE button sequentially.
- To return to the last alarm press the START/PAUSE button.
- The alarm sequence continues as long as the two buttons are held down.
- The alarm reading system is as described in paragraph 8.2.
- While the alarms are displayed, the appliance continues to perform the cycle or, if in the programme selection phase, maintains the previously-selected options in memory.

7.4 Cancelling the last alarm

It is good practice to cancel the last alarm:

- after reading the alarm code, to check whether the alarm re-occurs during diagnostics;
- after repairing the appliance, to check whether it re-occurs during testing.

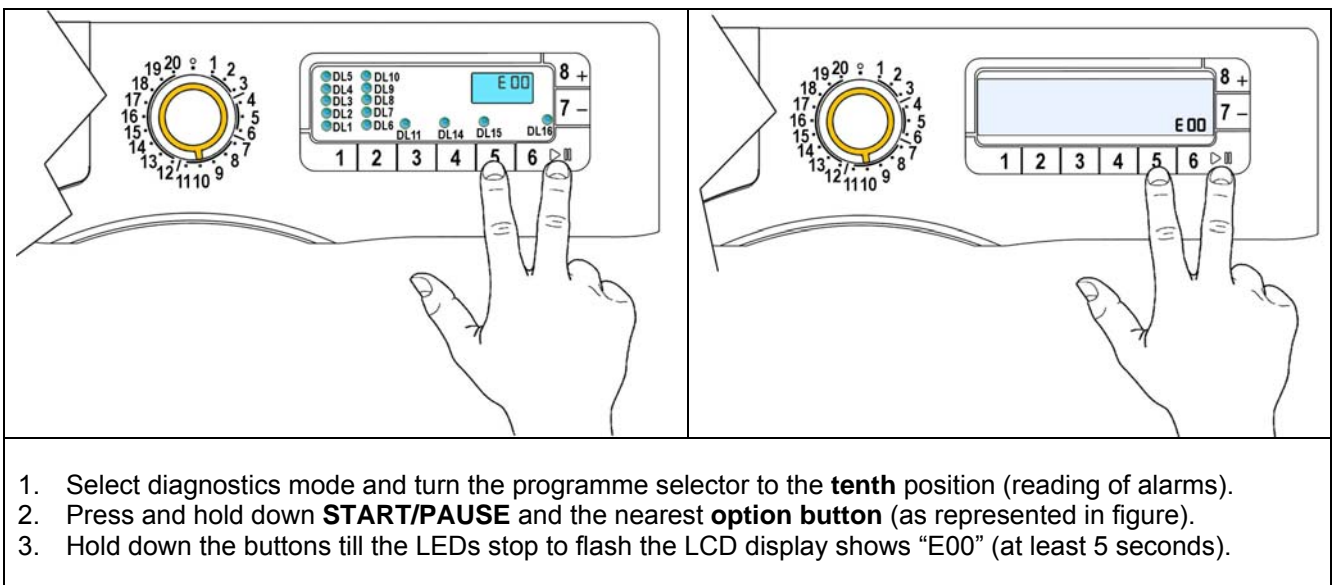

N.B. With this operation all the memorised alarms are deleted.

8 OPERATING TIME COUNTER

Using a specific procedure, the operator can display the total operating time for the appliance, which is counted from the moment it is first switched on.

This option is available only on models equipped with a display. The unit can count up to a maximum of **6550** hours of operating time.

- Only the operating time of normal programmes (and not diagnostic programmes) is counted
- The actual operating time for the cycle is counted (which does not include pauses, delayed start time, time of a stop with water in the drum, and soaking phases)
- The precision of the counter is 30 seconds per programme
- Only whole hours of operation are counted (1 hr and 59 min = 1 hr).

8.1.1 Reading of operating time

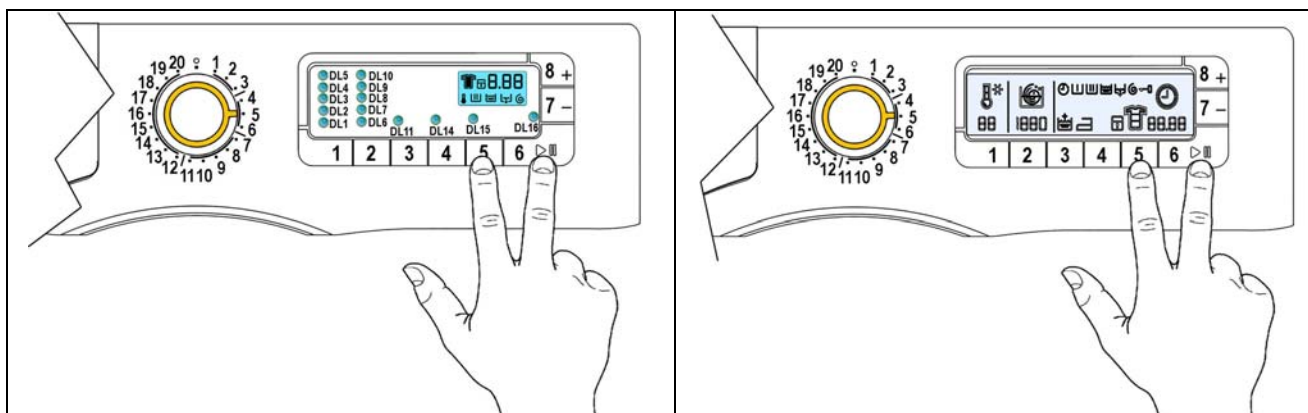





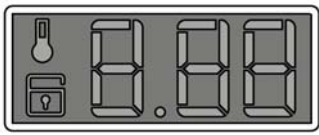
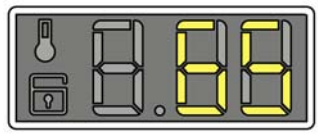
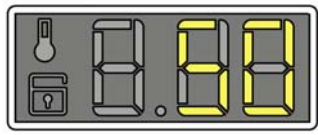

1. Switch off the appliance.
2. Press the **START/PAUSE** button and the nearest **option button** (see figure) simultaneously.
3. Holding the buttons down, switch on the appliance turning the programme selector of **five positions clockwise**.
4. Hold the buttons down till the LCD or the display show the working hours (at least 5 seconds).

8.1.2 Display of total operating time with LEDs

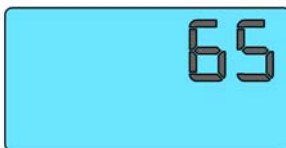
This time is displayed two digits at a time. The first two digits indicate the thousands and hundreds. The second two digits indicate the tens and units.

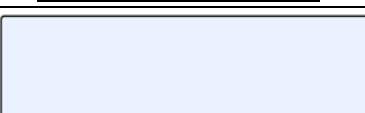
For example, if the operating time is **6550** hours, the display will show the following sequence:

	Phase 1 →	Phase 2 →	Phase 3 →
Styling	Nothing is displayed for <u>two seconds</u>	The following digits are displayed for <u>two seconds</u> : ↖ thousands (6) ↖ hundreds (5)	The following digits are displayed for the next <u>two seconds</u> : a. tens (5) b. units (0)
TC4			
TC3			
TC2			

At the end of the phase 3 (after displaying the tens and units) the cycle repeats. To return to normal mode it is possible to: switch the appliance off or press a button or turn the selector knob.

9 WASHING PROGRAMMES AND OPTIONS

9.1 Programmes

The washing programmes can be configured. The basic programmes are listed in the table below.

Programme	Temperature (°C)	Number of rinses	Final spin (rpm)	
Cotton	90	82	3	
	90E	67(*)	(**)	
	60	60	3	
	60E	55 (*)	(**)	
	50	50	3	
	50/40E	44(*)	(**)	
	40	40	3	
	30	30		
	cold	20	450/650/850/1000/1200/ 1300/1400/1600	
Synthetic fabrics	60	60		3
	60/50E	42(*)		(**)
	50	50		3
	40	42		
	30	30		
	cold	20		Max. 900
Mini Programme	30	30		3
	cold	20	Max. 900	
Delicates	40	40	3	
	30	30		
	cold	20		450/700
Wool Hand-wash	40	38	3	
	30	33		
	cold	20		Max. 1000
Shoes	40	40	3	
	30	30		
	cold	20		Max. 1000
Jeans	60	60	5	
	50	50		
	40	40		
	30	30		
	cold	20		450/650/850/1000/1200/ 1300/1400/1600
Soak	30/20	----	----	
Rinses	----	3	Max. 1600	
Conditioner	----	1	Max. 1600	
Drain	----	----	----	
Spin	----	----	Max. 1600	

The data are indicative.

(*) "Energy label" programmes

(**) In some countries the rinses are 3, in others 2

9.2 Options (for appliances EWM 2100 with universal motor)

The table below lists the possible options for the washing programmes, the compatibility of the various options and with the cycle, and when it is possible to select or modify the options.

The options can be selected in three ways:

- using the programme selector: in this case, the options are configured as special programmes;
- using the pushbuttons.

		OPTIONS																
		Rinse-hold	Night cycle	Pre-wash	Stains	Bleach	Extra rinse	Easy-iron	Economy (*)	Intensive	Normal	Daily	Light	Quick	Super Quick	Reduced spin speed	No spin	Half-load
Compatibility with PROGRAMMES	Cotton	90°C	X	X	X	X	X	X	X	X	X	X	X	X	X	X	X	X
		60°C	X	X	X	X	X	X	X	X	X	X	X	X	X	X	X	X
		50°C	X	X	X	X	X	X	X	X	X	X	X	X	X	X	X	X
		40°C	X	X	X	X	X	X	X	X	X	X	X	X	X	X	X	X
		30°C	X	X	X		X	X	X		X	X	X	X	X	X	X	X
		cold	X	X	X		X	X	X		X	X	X	X	X	X	X	X
	Synthetic fabrics	60°C	X	X	X	X		X	X	X		X	X	X		X	X	X
		50°C	X	X	X	X		X	X	X		X	X	X		X	X	X
		40°C	X	X	X	X		X	X	X		X	X	X		X	X	X
		30°C	X	X	X			X	X			X	X	X		X	X	X
		cold	X	X	X			X	X			X	X	X		X	X	X
	Delicates	40°C	X	X	X	X		X				X	X	X		X	X	X
		30°C	X	X	X			X				X	X	X		X	X	X
		cold	X	X	X			X				X	X	X		X	X	X
	Wool / Hand-wash	40°C	X	X												X		
		30°C	X	X												X		
		cold	X	X												X		
	Easy-iron	60°C	X		X			X	X			X				X	X	
		50°C	X		X			X	X			X				X	X	
		40°C	X		X			X	X			X				X	X	
		30°C	X		X			X	X			X				X	X	
		cold	X		X			X	X			X				X	X	
	Duvet	40°C										X				X		
		30°C										X				X		
	Jeans	60°C	X	X	X			X	X			X				X	X	
		50°C	X	X	X			X	X			X				X	X	
		40°C	X	X	X			X	X			X				X	X	
		30°C	X	X	X			X	X			X				X	X	
		cold	X	X	X			X	X			X				X	X	
	Shoes	40°C	X	X	X			X				X				X		
		30°C	X	X	X			X				X				X		
		cold	X	X	X			X				X				X		
	Lingerie	40°C	X	X												X	X	
30°C		X	X												X	X		
cold		X	X												X	X		
Silk	30°C	X	X											X	X	X		
	cold	X	X											X	X	X		
Baby	40°C	X	X	X			X				X				X	X		
	30°C	X	X	X			X				X				X	X		
	cold	X	X	X			X				X				X	X		
Mini, Flash, Sport, Light	30°C													X	X	X		
Hygienize	90°C	X	X	X	X	X	X			X					X	X		

(*) Economy

➤ Cotton: 90°C = Eco 67°C; 60°C = Energy Label; 50°-40°C = Eco 40° C AA

➤ Synthetics: 60-60°C= Eco 40°C

X Option included in the programme and cannot be deleted

		OPTIONS																
		Rinse-hold	Night cycle	Pre-wash	Stains	Bleach	Extra rinse	Easy-iron	Economy (*)	Intensive	Normal	Daily	Light	Quick	Super Quick	Reduced spin speed	No spin	Half-load
Compatibility with PROGRAMMES	Sport	40°C	X	X	X			X			X					X	X	
		30°C	X	X	X			X			X					X	X	
		cold	X	X	X			X			X					X	X	
	Shirts	30°C													X	X		
	Mixed°	40°C	X	X	X	X	X	X		X						X	X	X
		90°C	X	X		X		X	X			X				X	X	X
	Hygienize	60°C	X	X		X		X	X			X				X	X	X
		50°C	X	X		X		X	X			X				X	X	X
		40°C	X	X		X		X	X			X				X	X	X
	Grass	60°C	X	X	X	X		X	X		X					X	X	
		50°C	X	X	X	X		X	X		X					X	X	
		40°C	X	X	X	X		X	X		X					X	X	
	Soak	30°C														X		
	Rinses		X	X			X	X	X							X	X	
	Rinses delicates		X	X				X								X	X	
	Conditioner		X	X					X							X	X	
Delicate conditioner		X	X					X							X	X		
Drain																		
Spin															X			
Delicate spin															X			

(*) Economy

➤ Cotton: 90°C = Eco 67°C; 60°C = Energy Label; 50° = Eco 48°C; 40°C = Eco 44°C AA

➤ Synthetics: 60-60°C = Eco 40°C

X Option included in the programme and cannot be deleted

9.3 Options (for appliances EWM2500 with asynchronous motor and inverter)

The table below lists the possible options for the washing programmes, the compatibility of the various options and with the cycle, and when it is possible to select or modify the options.

The options can be selected in different ways:

- using the programme selector: in this case, the options are configured as special programmes;
- using the pushbuttons.

		OPTIONS																
		Rinse-hold	Night cycle	Pre-wash	Stains	Bleach	Extra rinse	Easy-iron	Economy (*)	Intensive	Normal	Daily	Light	Quick	Super Quick	Reduced spin speed	No spin	Half-load
Compatibility with PROGRAMMES	Cotton	90°C	X	X	X	X	X	X	X	X	X	X	X	X	X	X	X	X
		60°C	X	X	X	X	X	X	X	X	X	X	X	X	X	X	X	X
		50°C	X	X	X	X	X	X	X	X	X	X	X	X	X	X	X	X
		40°C	X	X	X	X	X	X	X	X	X	X	X	X	X	X	X	X
		30°C	X	X	X		X	X	X		X	X	X	X	X	X	X	X
		cold	X	X	X		X	X	X		X	X	X	X	X	X	X	X
	Synthetic fabrics	60°C	X	X	X	X		X	X	X		X	X	X		X	X	X
		50°C	X	X	X	X		X	X	X		X	X	X		X	X	X
		40°C	X	X	X	X		X	X	X		X	X	X		X	X	X
		30°C	X	X	X			X	X			X	X	X		X	X	X
		cold	X	X	X			X	X			X	X	X		X	X	X
	Delicates	40°C	X	X	X	X		X				X	X	X		X	X	X
		30°C	X	X	X			X				X	X	X		X	X	X
		cold	X	X	X			X				X	X	X		X	X	X
	Wool / Hand-wash	40°C	X	X												X		
		30°C	X	X												X		
		cold	X	X												X		
	Easy-iron	60°C	X		X			X	X			X				X	X	
		50°C	X		X			X	X			X				X	X	
		40°C	X		X			X	X			X				X	X	
		30°C	X		X			X	X			X				X	X	
		cold	X		X			X	X			X				X	X	
	Duvet	40°C										X				X		
		30°C										X				X		
	Jeans	60°C	X	X	X			X	X			X				X	X	
		50°C	X	X	X			X	X			X				X	X	
		40°C	X	X	X			X	X			X				X	X	
		30°C	X	X	X			X	X			X				X	X	
		cold	X	X	X			X	X			X				X	X	
	Shoes	40°C	X	X	X			X				X				X		
		30°C	X	X	X			X				X				X		
		cold	X	X	X			X				X				X		
Lingerie	40°C	X	X												X	X		
	30°C	X	X												X	X		
	cold	X	X												X	X		
Silk	30°C	X	X											X	X	X		
	cold	X	X											X	X	X		
Baby	40°C	X	X	X			X				X				X	X		
	30°C	X	X	X			X				X				X	X		
	cold	X	X	X			X				X				X	X		
Mini, Flash, Sport, Light	30°C													X	X	X		
Hygienize	90°C	X	X	X	X	X	X			X					X	X		

(*) Economy

➤ Cotton: 90°C = Eco 67°C; 60°C = Energy Label; 50°-40°C = Eco 40° C AA

➤ Synthetics: 60-60°C= Eco 40°C

X Option included in the programme and cannot be deleted

		OPTIONS																	
		Rinse-hold	Night cycle	Pre-wash	Stains	Bleach	Extra rinse	Easy-iron	Economy (*)	Intensive	Normal	Daily	Light	Quick	Super Quick	Reduced spin speed	No spin	Half-load	
Compatibility with PROGRAMMES	Sport	40°C	X	X	X			X									X	X	
		30°C	X	X	X			X									X	X	
		cold	X	X	X			X									X	X	
	Shirts	30°C													X		X		
	Mixed°	40°C	X	X	X	X	X	X		X							X	X	X
		90°C	X	X		X		X	X								X	X	X
	Hygienize	60°C	X	X		X		X	X								X	X	X
		50°C	X	X		X		X	X								X	X	X
		40°C	X	X		X		X	X								X	X	X
		60°C	X	X	X	X		X	X		X						X	X	
	Grass	50°C	X	X	X	X		X	X		X						X	X	
		40°C	X	X	X	X		X	X		X						X	X	
		60°C	X					X								X	X		
	Express	90°C	X	X	X	X	X	X		X	X	X	X	X	X	X	X	X	
	Sensitive plus	60°C	X	X	X	X	X	X		X	X	X	X	X	X	X	X	X	
		50°C	X	X	X	X	X	X		X	X	X	X	X	X	X	X	X	
		40°C	X	X	X	X	X	X		X	X	X	X	X	X	X	X	X	
		30°C	X	X	X		X	X		X	X	X	X	X	X	X	X	X	
		cold	X	X	X		X	X		X	X	X	X	X	X	X	X	X	
	Rapid	30°C	X					X									X		
	Soak	30°C			X														
	Rinses			X			X	X	X								X	X	
	Rinses delicates			X				X									X	X	
Conditioner			X					X								X	X		
Delicate conditioner			X					X								X	X		
Drain																			
Spin																X			
Delicate spin																X			

(*) Economy

➤ Cotton: 90°C = Eco 67°C; 60°C = Energy Label; 50°= Eco 48°C;40°C = Eco 44°C AA

➤ Synthetics: 60-60°C = Eco 40°C

- X Option included in the programme and cannot be deleted
- X Only for JETSYSTEM+FLOWMETER

9.3.1 Compatibility between Options

		OPTIONS																
		Rinse-hold	Night cycle	Pre-wash	Stains	Bleach	Extra rinse	Easy-iron	Economy (*)	Intensive	Normal	Daily	Light	Super Quick	Reduced spin speed	No spin	Half-load	Rinse-hold
Compatibility with OPTIONS	Rinse-hold			X	X	X	X	X	X	X	X	X	X	X	X			X
	Night cycle			X	X	X	X		X	X	X	X	X	X	X			X
	Pre-wash	X	X		(*)	(*)	X	X	X	X	X	X	X	X	X	X	X	X
	Stains	X	X	(*)		(*)	X	X	X	X	X	X	X	X	X	X	X	X
	Bleach	X	X	(*)	(*)		X	X	X	X	X	X	X	X	X	X	X	
	Super rinse	X	X	X	X	X		X	X	X	X	X	X	X	X	X	X	X
	Easy-iron	X		X	X	X	X		X	X	X	X	X	X	X	X	X	X
	Economy	X	X	X	X	X	X										X	X
	Intensive	X	X	X	X	X	X	X									X	X
	Normal	X	X	X	X	X	X	X									X	X
	Daily	X	X	X	X	X	X	X									X	X
	Light	X	X	X	X	X	X	X									X	X
	Quick	X	X	X	X	X	X	X									X	X
	Super Quick	X	X	X	X	X	X	X									X	X
	Reduced spin speed			X	X	X	X	X	X	X	X	X	X	X	X	X		X
	No spin			X	X	X	X	X	X	X	X	X	X	X	X	X		X
	Half-load	X	X	X	X		X	X	X	X	X	X					X	X
Phases in which selection or modification are possible	Selection	X	X	X	X	X	X	X	X	X	X	X	X	X	X	X	X	
	Pre-wash	X	X		X	X	X	X								X	X	
	Wash	X	X		X	X	X									X	X	
	Rinses	X	X															
	Spin																	

- (*) Prewash, Stains and Bleach are compatible depending on which detergent drawer is used.
- The delayed start is compatible with all programmes, except for the drain; the max. time that can be selected is 20 hours.
 - The spin selection is available for all programmes except for the drain.

The table below shows other limitations in the compatibility of the options due to the drawer type and electric valve number.

	4C-3V	4C-2V	3C-2V
PREWASH / SOAK	▶	▶	▶
BLEACHING	◆	▶	◇
STAINS	▶	▶	▶

- 4C= 4-compartment drawer
 3C= 3-compartment drawer
 3V= 3 electric valves
 2V= 2 electric valves
- ◇ = Option not available
 ◆ = Option available
 ▶ = Only one of these options can be selected

9.4 Description of options

- **Rinse-hold**
 - Stops the appliance with water in the tub before the final spin cycle.
 - To drain the water, reset the programme and then select a drain or spin cycle.
- **Night cycle**
 - Eliminates all spin phases and adds **three** rinses in COTTON cycles and **two** rinses in SYNTHETICS cycles.
 - Stops the appliance with water in the tub before the final rinse.
 - Eliminates the buzzer (if configured)
 - To drain the water, reset the programme and then select a drain or spin cycle.
- **Pre-wash**
 - Adds a pre-wash phase at the start of the cycle with water heating to 30°C (or cold, if selected).
 - In COTTON and SYNTHETICS cycles, performs a short spin before passing to the washing phase.
 - This option cannot be selected for WOOL and HAND-WASH cycles.
- **Soak**
 - Adds a pre-wash phase (with a duration of 30' with wool cycle movement) at the start of the cycle with water heating to 30°C (or cold, if selected).
 - In COTTON and SYNTHETICS cycles, performs a short spin before passing to the washing phase.
 - Together with the delayed start option it is possible to select a soak time from 30min to 10 hours.
 - This option cannot be selected for WOOL and HAND-WASH cycles.
- **Stains**
 - Adds a 5-minute motor movement phase after heating to 40°C.
 - Ducts water to the pre-wash/stains compartment in order to introduce the special stain-removal product.
 - This option cannot be selected for DELICATES, WOOL and HAND-WASH cycles.
- **Bleach**
 - Ducts water through the bleach compartment at the beginning of the first rinse in COTTON cycles.
- **Economy / Energy label**
 - Modifies the structure of the COTTON 40-60 and SYNTHETICS 50/60 programmes in order to reduce energy consumption.
 - Reduces the washing temperature.
 - Increases the duration of the wash phase.
- **Super-rinse**
 - Adds **two** rinses in the COTTON, SYNTHETICS and DELICATES cycles.
 - Eliminates the intermediate spin cycles, with the exception of the final rinse, which is reduced to 450 rpm.
- **Half-load**
 - Eliminates one rinse in COTTON programmes.
- **Easy-Iron**
 - In COTTON programmes:
 - adds **three** rinse cycles
 - eliminates the intermediate spin cycles
 - performs an impulse spin phase
 - adds an "untangling" phase after the spin cycle
 - In SYNTHETICS cycles:
 - reduces the heating temperature in 50/60° cycles to 40°C
 - increases the washing time
 - prolongs the cooling phase at the end of the washing phase
 - adds **one** rinse
 - adds an "untangling" phase after the impulse spin cycle

- **Reduced spin speed**

→ Reduces the speed of **all** spins as shown in the table.

Maximum spin speed (rpm)	600	700	800	900	1000	1100	1200	1300	1400	1550
Reduction for COTTON (rpm)	450	450	450	450	500	550	600	650	700	750
Reduction for ALL OTHER CYCLES (rpm)	450	450	450	450	450	450	450	450	450	450

- **No spin**

→ Eliminates **all** the spin phases.

→ If selected, three rinses are added in the COTTON cycle and one in the SYNTHETICS cycle.

- **Intensive**

→ Performs a specific intensive cycle.

- **Daily**

→ Modifies the structure of the COTTON - SYNTHETICS - DELICATES cycles to obtain a good washing performance with a short time.

- **Light**

→ Modifies the structure of the wash phase of the COTTON - SYNTHETICS - DELICATES cycles in a short time.

- **Short**

→ Modifies the structure of the COTTON - SYNTHETICS - DELICATES cycles to obtain very short washing times (optimized for reduced wash loads and very dirty).

→ Reduces the number of rinses (one rinse less).

→ Increases the water level of the other two rinses.

- **Very short**

→ Modifies the structure of the wash phase of the COTTON - SYNTHETICS - DELICATES cycles for half load.

- **Delayed-start time**

→ Adds a pause before the start of the programme. The delay time is displayed on the corresponding LEDs starting from a 2-hour till a 20-hour delay (☞ 30' ☞ 60' ☞ 90' ☞ 2h ☞ 3h... ☞ 20h ☞ 0h).

→ To start the cycle immediately after selecting a delayed start:

press START/PAUSE, cancel the delay time by pressing the appropriate button, then press START/PAUSE again.

10 TECHNICAL CHARACTERISTICS

10.1 Control system memory



10.1.1 General structure of the memory system

The system features an EEPROM memory module, fitted externally to the microprocessor, which serves to memorize the configuration data, the description of the cycle, the status of the appliance in the event of a power failure, and the alarms.

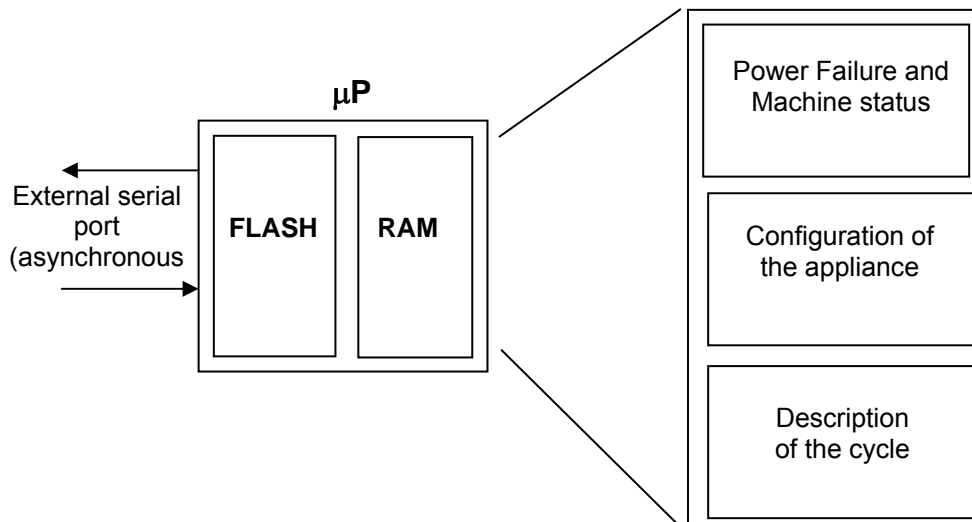

10.1.2 FLASH

This area memory contains the firmware code relative to the functions of the appliance:

- ⇒ Control of electrical loads (motor, pump, solenoid valves etc.).
- ⇒ Control of the sensors (pressure switches, motor speed, door status etc.).
- ⇒ Control of the user interface
- ⇒ Control of the serial port
- ⇒ Control of power failure procedure and alarms
- ⇒ Execution of the washing programme
- ⇒ Power failure, i.e. the information necessary to restart the appliance in the event of a power failure:
 - Selected cycle and options
 - Current phase and sub-phase
- ⇒ Machine status, used to perform special cycles such as:
 - Electrical test (used in the assembly line)
 - Continuous cycles (used in the factory workshop)
- ⇒ Machine configuration: the data contained in the EEPROM define the characteristics of the model and are interpreted by the function software. The variables are as follows:
 - Type of appliance (front-loader, top-loader, compact)
 - Type of door interlock (PTC or instantaneous)
 - Anti-flooding safety device
 - Transmission ratio between drum pulley and motor pulley
 - Structure of the washing group
 - Power supply frequency (50/60 Hz)
 - Type of PCB (horizontal or vertical buttons)
 - Detergent drawer (3 or 4 compartments)
 - Final spin speed (600 – 1400 rpm)
- ⇒ Identification of the appliance:
 - Prod. N.
 - ELC
 - Serial number
- ⇒ Configuration of the user interface:
 - Programmes on main selector
 - Function of secondary selector (if featured)
 - Number and functions of buttons
 - Functions of the LEDs
 - Operation of the buzzer

- ⇒ Washing cycle tables: Each washing cycle consists of a series of phases (steps); the steps are the basic instructions which comprise the description of the cycle, which is common to all appliances having the same characteristics:
 - Water fill
 - Motor movement
 - Reset
 - Heating
 - Drain
 - Spin
 - "IF" conditions (options, temperatures etc.)
- ⇒ Configuration of the washing cycle: for each family of appliances, certain parameters associated with the washing programme are defined:
 - Operational limits (voltage/frequency)
 - Transmission ratios
 - Parameters for control of the signal from the tachometric generator
 - Parameters for half-range operation of the motor
 - Structure of the washing group
 - Control parameters for the FUCS anti-unbalancing system
 - Water fill control algorithm
 - Alarm control system
 - Sensor parameters (flowmeter etc...)

10.1.3 RAM

The RAM (Random-Access Memory) contains the variables, i.e. all the dynamic information used during execution of the programme:

- ⇒ Motor speed
- ⇒ Water temperature
- ⇒ Alarms
- ⇒ Cycle selected
- ⇒ Machine status

The RAM is cancelled when the power supply is disconnected (power failure or appliance switched off).

The contents of the RAM can be read using a computer connected via a DAAS interface.

The same system can be used to send commands to the electronic control unit such as:

- ⇒ Select remote control mode
- ⇒ Action the various loads in remote mode
- ⇒ Select diagnostics mode
- ⇒ Select a cycle and options, and start the cycle

10.2 Door interlock

There are two types of door interlock:

- voltmetric with PTC
- instantaneous

10.2.1 Voltmetric interlock with PTC

- 10 Suppressor
- 19 Door interlock
- 20 PCB

ON/OFF = Main switch (programme selector)

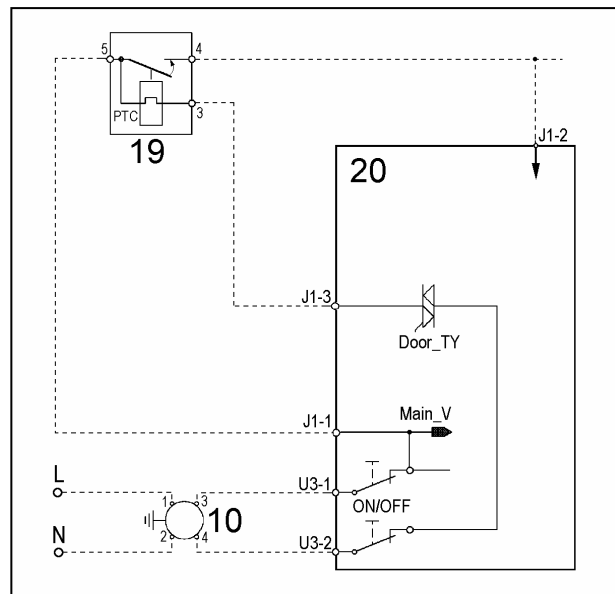

10.2.1.1 Operating principle

- ↻ When the washing programme is started by pressing the START/PAUSE button, the bi-metal PTC (contacts 3-5) is powered by the triac on the PCB: after 2 – 4 seconds, this closes the switch (5-4) which powers the electrical components of the appliance (only if the door is closed).
- ↻ The door interlock prevents aperture of the door while the appliance is in operation.
- ↻ At the end of the washing programme, the PCB disconnects the interlock from the power supply, but the door remains locked for 1 to 3 minutes (PTC cooling time).

10.2.2 Instantaneous door interlock

- With this safety device it is possible to open the door immediately after the end of the cycle.

9 Door interlock
19 Suppressor
20 PCB

ON/OFF = Main switch (programme selector)

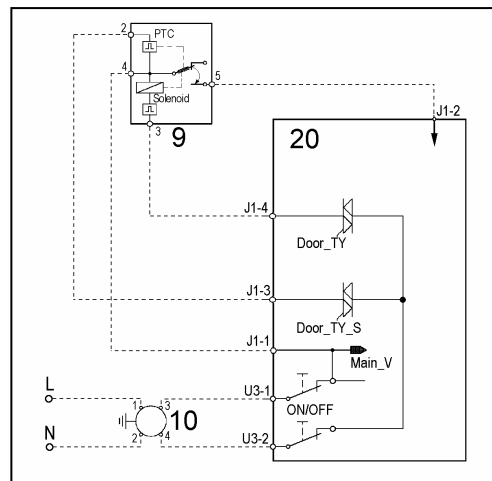

10.2.2.1 Operating principle

- ↪ When the ON/OFF switch closes and the appliance is switched on, power is applied to the bimetallic PTC switch (contact 4-2), but the door remains unlocked.
- ↪ When the programme starts (Start/Pause button), the main board sends a 20 msec pulse to contacts 4-3 on the solenoid (at least 6 seconds must have passed since the appliance was switched on). This locks the door and simultaneously closes the main switch (contacts 4-5), thus applying power to all components on the appliance.
- ↪ When the programme ends, the main board sends two additional 20 msec pulses (200 msec apart):
 - the first pulse does not unlock the door
 - the second pulse (which is sent only if the appliance is operating properly) unlocks the door lock device and simultaneously opens the contacts on the main switch.

10.2.2.2 Conditions required for opening the door

- ↪ Before pulses are sent to open the door, the main board checks for the following conditions:
 - The drum must not be moving (no signal from the tachometric generator).
 - The water level must not be higher than the bottom of the door.
 - The water temperature must not exceed 40° C.

10.2.2.3 Automatic unlock

If a power failure occurs, if the appliance is shut off, or if the solenoid malfunctions, the bimetallic PTC will cool down and the door will unlock in 1 - 4 minutes.

10.3 Water fill system

The electric valves are powered by the PCB by means of the triac and the control of the water level in the tub is carried out by the analogue pressure switch.

- 3 Analogue pressure switch
- 5 Prewash electric valve
- 6 Wash electric valve
- 7 Bleach electric valve
- 20 PCB

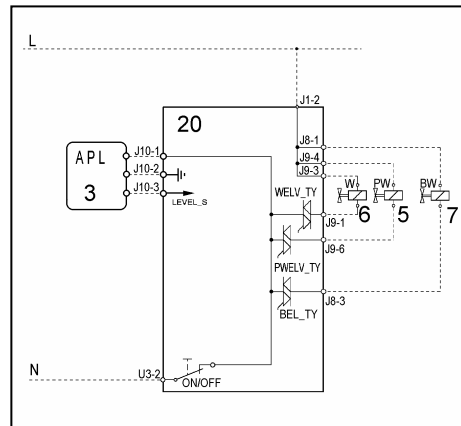

10.4 Analogue pressure switch of water level control in the tub

General features

The electronic pressure switch is an analogue device that controls the water level in the tub, used in the models with electronic control and it is directly connected to the main PCB.

ELECTRONIC PRESSURE SWITCH		
Electronic circuit	Electric symbol	

The pressure switch is connected by a hose to the pressure chamber.

When the tub is filled with water, the pressure created inside the hydraulic circuit expands the diaphragm. This in turn modifies the position of the core inside the coil, thus changing the inductance and the frequency of the oscillating circuit.

The electronic PCB, according to the frequency, recognizes the quantity of the water in the tub.

- 1 hose
- 3 coil
- 5 core

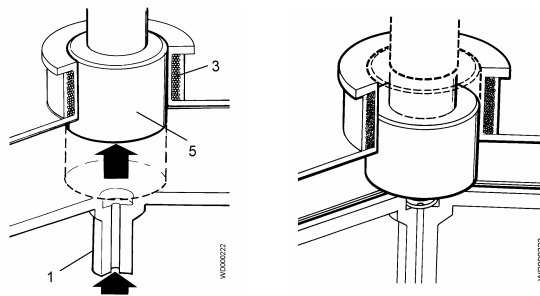

Frequency variation according to the water quantity in the tub

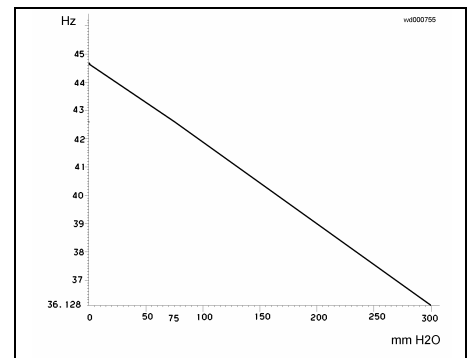

10.5 Drain pump

- 15 Drain pump
- 16 Thermal protector
- 20 PCB

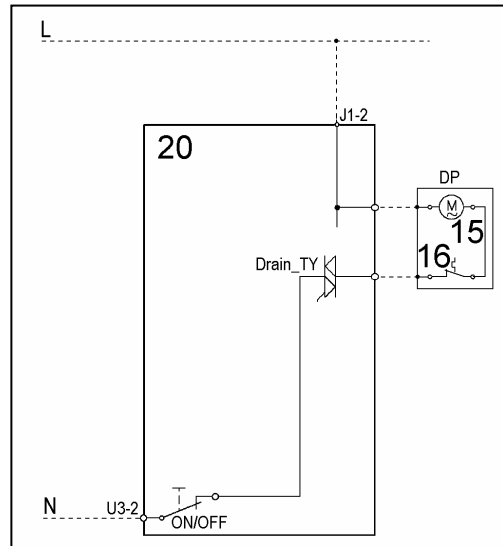

The PCB powers the drain pump via a triac as follows:

- until the electronic pressure switch closes on empty, after which the pump is actioned for a brief period or passes to the subsequent phase;
- for a pre-determined period (and eventually an alarm appears).

10.6 Recirculation pump (if featured)

On jetsystem models, the main board powers the recirculation pump through a triac.

- 17 Drain pump
- 18 Thermal protector
- 20 PCB

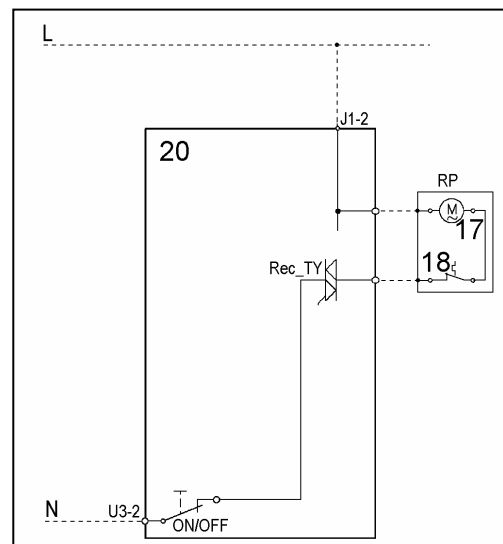

10.7 Heating



- 2 NTC temperature sensor
- 13 Heating element (with thermal fuses)
- 14 PCB
- K1 Relay

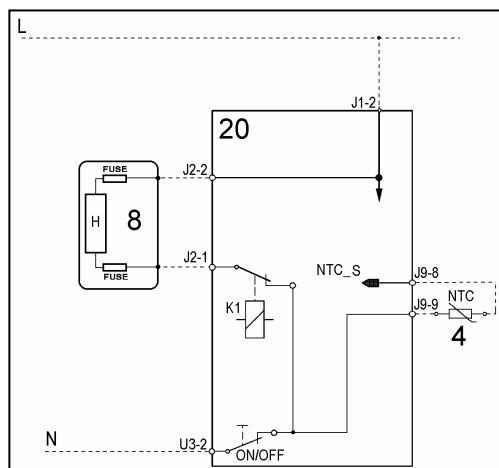

- 1. Tubular casing
- 2. Thermal fuses
- 3. NTC Sensor
- 4. Connectors

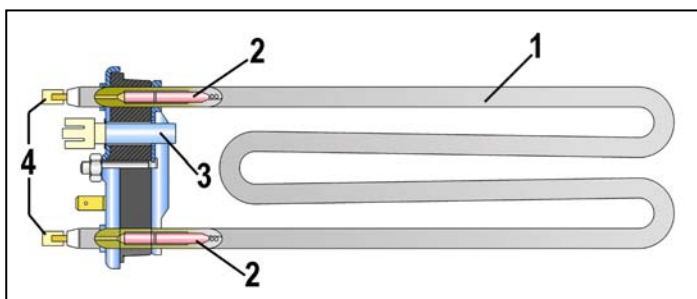

The heating element is powered by a relay (K1) of the electronic board and is provided with two thermal fuses, which interrupt if the temperature degree exceeds the values by which they are calibrated.

WARNING



In case of replacement of the heater, replace it with one with the same characteristics in order not to compromise the safety of the appliance.

10.8 Temperature sensor

The temperature is controlled by the PCB by means of a NTC temperature sensor incorporated in the heating element.

- 1. NTC resistor
- 2. Metallic capsule
- 3. Terminals
- 4. Plastic casing

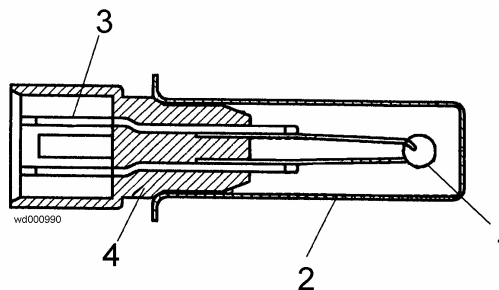

TEMPERATURE (°C)	RESISTANCE (Ω)		
	Nominal value	Maximum value	Minimum value
20	6050	6335	5765
60	1250	1278	1222
80	640	620	660

10.9 Universal motor (EWM 2100)

- 11 Tachometric generator
- 12 Stator
- 13 Protector
- 14 Rotor
- 20 PCB

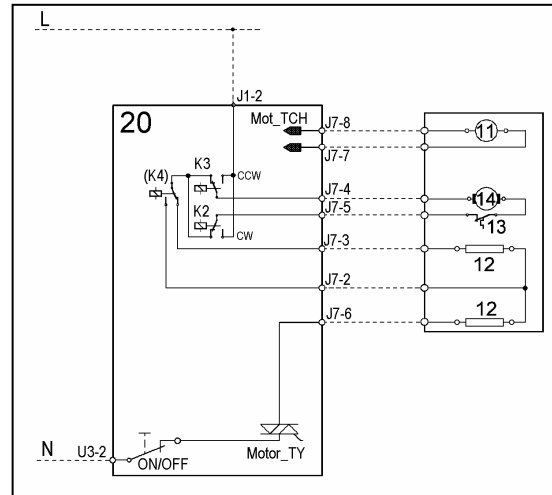

10.9.1 Power supply to motor

The PCB powers the motor via a triac. The direction of rotation is reversed by switching of the contacts on the two relays (K2-K3), which modify the connection between the rotor and the stator. In certain models, a third relay (K4) is used to power the stator (full or half field) according to the spin speed. The speed of rotation of the motor is determined by the signal received from the tachometric generator. During the spin phases, the microprocessor performs the anti-foam and the anti-unbalancing control procedure.

10.10 Three-phase asynchronous motor (EWM2500)

- 11. Tachometric generator
- 20. PCB
- 23. Inverter
- 24. Motor

X-Y-X = Motor windings

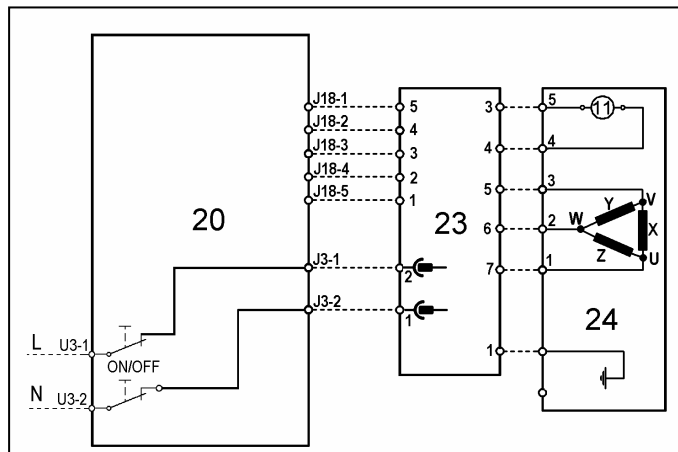

10.10.1 Power supply to motor

Three-phase power is fed by the inverter (4) which sends, through the connectors 5-6-7, the three phases to connectors 1-2-3 on the motor (nodes V-W-U), where the windings (Y-X-Z-) are connected. The phase shift between the phases is 120° and peak amplitude is 310V.

The condition of the motor can be determined by measuring the resistance of the windings:

- Winding y ohm 5,4 ~ ±7% (contacts 2-3)
- Winding x ohm 5,4 ~ ±7% (contacts 1-2)
- Winding z ohm 5,4 ~ ±7% (contacts 1-3)
- Winding T (tachometric) ohm 121 ~ ±7% (contacts 4-5)

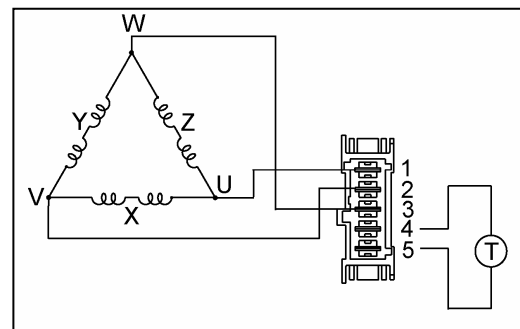

- The electrical components must be serviced by qualified personnel only.
- Unplug the appliance before accessing internal components.

10.11 Anti-foam control system

The anti-foam control procedure (if featured) is performed via the electronic pressure switch.

Spin phase without foam

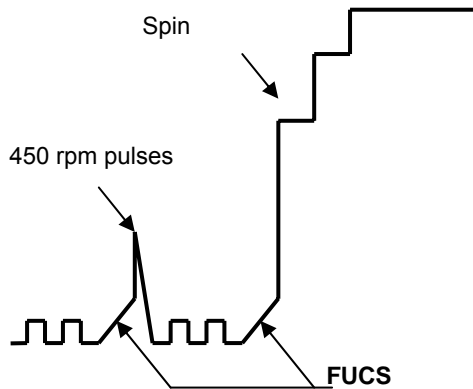

Spin phase with little foam

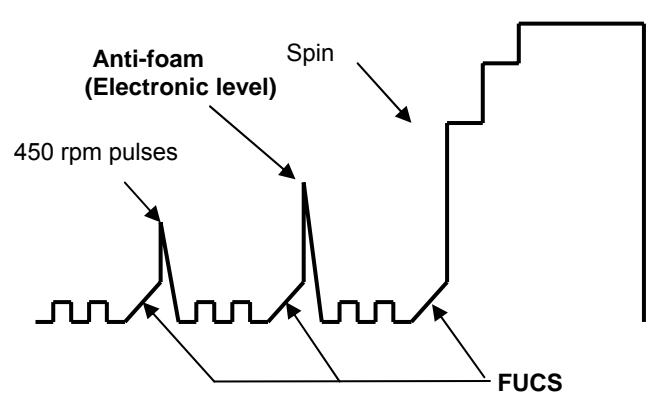

- **Spin with little foam:** if the contact of the electronic pressure switch closes on FULL, the spin phase is interrupted; the drain pump continues to operate and, when the contact returns to EMPTY, the spin phase is resumed.
- **Spin with excessive foam in the tub (critical situation):** The control system detects whether the electronic pressure switch commutates 5 times to FULL. In this case, the spin phase is skipped, and a one-minute drain cycle is performed with the motor switched off; in the case of a washing phase, a supplementary rinse is added.

10.12 “FUCS” (Fast Unbalance Control System)

The control procedure for unbalanced loads is performed dynamically, before each spin cycle, as follows:

- ↻ The phase begins at a speed of 55 rpm; the speed can never fall below this threshold, otherwise the check is repeated.
- ↻ At intervals of 300 ms, the balance is calculated and compared with predetermined limits. If the value is less than the lower limit, the speed of the drum is increased by a certain value depending on the transmission relation between motor pulley/drum; if the unbalancing is higher, it is decreased by the same value. The reduction in the speed of the drum distributes the washing correctly; this procedure is repeated until the wash load is completely balanced.
- ↻ Correct balancing of the wash load is achieved at a speed of 115 rpm, after which the spin cycle begins.

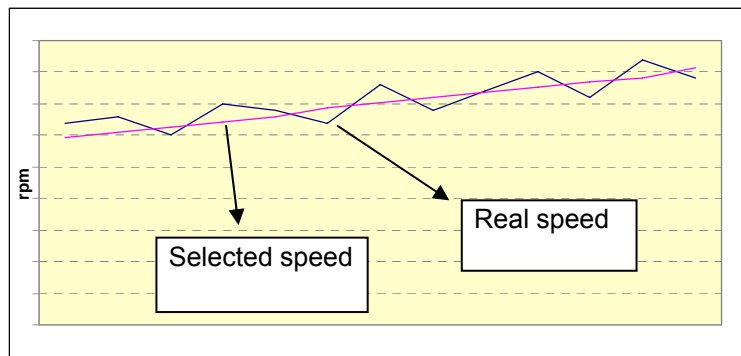

The Unbalancing Control function takes place in different phases: each phase is characterized by:

- ↻ an unbalancing index (0-1-2-3)
- ↻ an unbalancing threshold value (ex: 850, 350, 650, 1100rpm)
- ↻ a time out (max. time)

• Ending of the FUCS balancing phase

The phase is ended when:

- ↻ The drum rotation speed is 115 rpm (or 85rpm in some cases of unbalancing index). In this case the spin is performed.
- ↻ In some cases the optimal balancing value is not reached: a reduced spin is performed depending on the unbalancing.
- ↻ In the worst case, in which all phases are not sufficient to reach a minimum balancing value, the spin is not performed.

• Example of perfect balancing

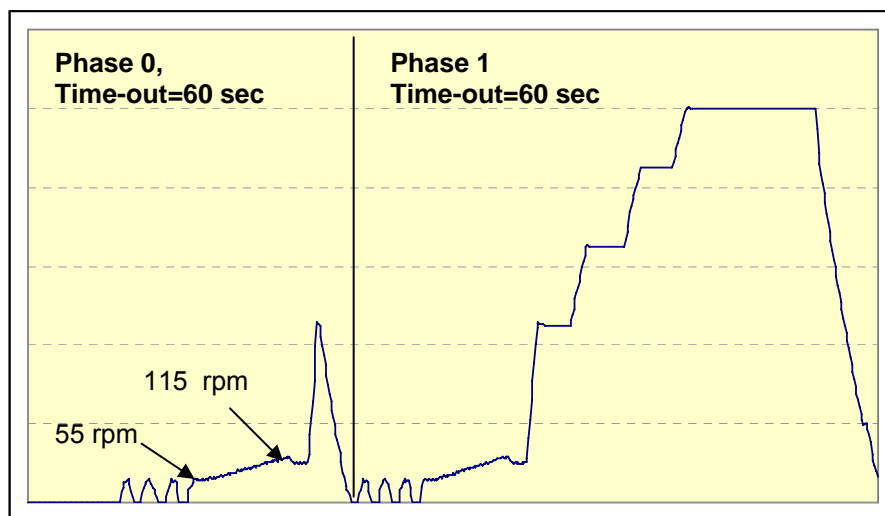

- **Balancing in the available longer interval**

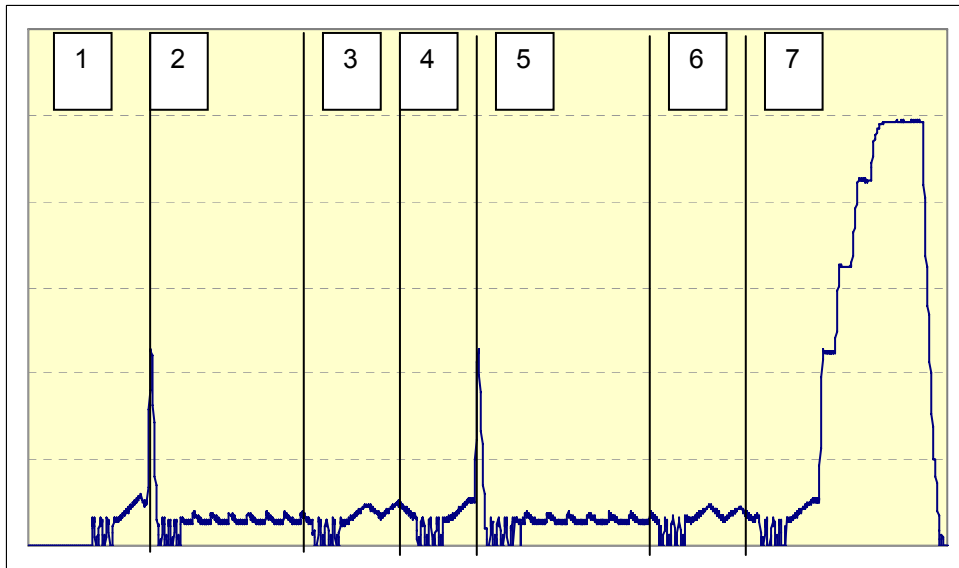

Phase	Unbalancing index	Time-out (sec)
1	0	60
2	1	120
3	2	60
4	3	90
5	1	120
6	2	90
7	3	90

- **Unbalancing after all phases**

In this case the spin (or impulse) is not performed.

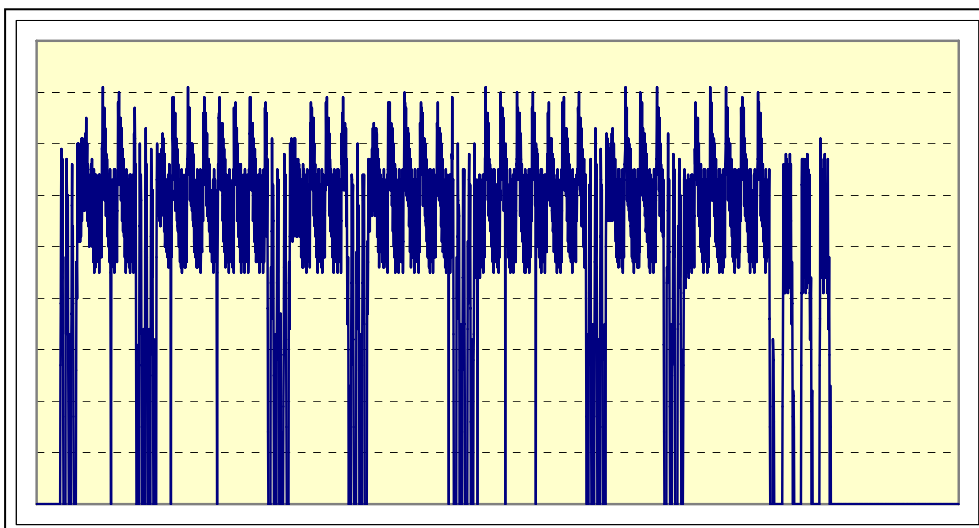

10.13 Table of alarm codes

Alarm	Possible fault	Action/machine status	Reset
E11	Tap closed or water pressure too low; Drain tube improperly positioned; Water fill solenoid valve is faulty; Leaks from water circuit on pressure switch; Pressure switch faulty; Wiring faulty; PCB faulty.	Cycle is paused with door locked.	START/RESET
E13	Drain tube improperly positioned; Water pressure too low; Water fill solenoid valve is faulty; Water circuit on pressure switch is leaking/clogged; Pressure switch faulty.	Cycle is paused with door locked.	START/RESET
E21	Drain tube kinked/clogged/improperly positioned; Drain filter clogged/dirty; Drain pump faulty; Pressure switch faulty; Wiring faulty; PCB faulty; Electrical current leak between heating element and ground.	Cycle is paused (after 2 attempts).	START/RESET
E23	Drain pump faulty; Wiring faulty; PCB faulty.	Safety drain cycle - Cycle stops with door unlocked.	RESET
E24	PCB faulty.	Safety drain cycle - Cycle stops with door unlocked.	RESET
E31	Pressure switch; Wiring; Main PCB.	Cycle stops with door locked.	RESET
E32	Tap is closed or water pressure is too low; Solenoid valve; Water circuit on pressure switch; pressure switch; Wiring; main board.	Cycle is paused.	START/RESET
E35	Water fill solenoid valve is faulty; Leaks from water circuit on pressure switch; Pressure switch faulty; Wiring faulty; PCB faulty.	Cycle stops. Safety drain cycle. Drain pump continues to operate (5 min. on, then 5 min. off, etc.).	RESET
E38	Water circuit on pressure switches; Pressure switches; Motor belt broken.	Heating phase is skipped.	ON/OFF RESET
E3A	PCB faulty.	Cycle stops with door locked.	RESET
E41	Door lock unit faulty; Wiring faulty; PCB faulty.	Cycle is paused.	START/RESET
E42	Door lock unit faulty; Wiring faulty; PCB faulty; Electrical current leak between heating element and ground.	Cycle is paused.	START/RESET
E43	Door lock unit faulty; Wiring faulty; PCB faulty.	(Safety drain cycle) Cycle stops.	ON/OFF RESET
E44	PCB faulty.	(Safety drain cycle) Cycle stops.	ON/OFF RESET
E45	PCB faulty.	(Safety drain cycle) Cycle stops.	ON/OFF RESET
E51	PCB faulty; current leakage from motor or from wiring.	Cycle blocked, door locked (after 5 attempts).	RESET
E52	Motor faulty; wiring faulty; PCB faulty.	Cycle blocked, door locked (after 5 attempts).	RESET
E53	PCB faulty.	Cycle blocked.	RESET
E54	PCB faulty; current leakage from motor or from wiring.	Cycle blocked, door locked (after 5 attempts).	RESET
E57	Motor defective; Wiring defective on inverter for motor, inverter board defective.	Cycle stops with door locked (after 5 attempts).	RESET

Alarm	Possible fault	Action/machine status	Reset
E58	Motor defective; Wiring defective on inverter for motor, inverter board defective, abnormal motor operation (motor overloaded).	Cycle stops with door locked (after 5 attempts).	RESET
E59	Motor defective; Wiring defective on inverter for motor; Inverter board defective.	Cycle stops with door locked (after 5 attempts).	RESET
E5A	Inverter board defective. NTC open (on the inverter board). Overheating caused by continuous operation or ambient conditions (let appliance cool down)	Cycle stops with door locked (after 5 attempts).	RESET
E5B	Wiring defective, Inverter board defective	Cycle stops with door locked (after 5 attempts).	RESET
E5C	Inverter board defective, the masters voltage is too high (measure the masters voltage)	Cycle stops with door locked (after 5 attempts).	RESET
E5D	Line interference, Wiring defective, defective main board or inverter board	Cycle stops with door locked (after 5 attempts).	RESET
E5E	Defective wiring between main board and inverter board, Defective inverter board, defective main board.	Cycle stops	ON/OFF
E5F	Defective inverter board, Defective wiring, defective main board	Cycle stops with door locked (after 5 attempts).	RESET
E61	NTC sensor faulty; heating element faulty; wiring faulty; PCB faulty.	The heating phase is skipped.	START/RESET
E62	NTC sensor faulty; heating element faulty; wiring faulty; PCB faulty.	Safety drain cycle – Cycle stopped with door open.	RESET
E66	PCB faulty .	Safety drain cycle – Cycle stopped with door open.	RESET
E68	Earth-leakage between heater and earth.	Cycle blocked with door open.	RESET
E71	Faulty NTC sensor; Wiring faulty; PCB faulty.	Heating is skipped.	START/RESET
E74	NTC sensor improperly positioned; Faulty NTC sensor; Wiring faulty; PCB faulty.	Heating is skipped.	START/RESET
E82	PCB faulty (Wrong configuration data). Selector, wiring	-----	RESET
E83	PCB faulty (Wrong configuration data). Selector, wiring	Cycle cancelled.	START/RESET
E91	Wiring faulty; Faulty control/display board PCB faulty.	-----	RESET
E92	Wrong control/display board; Wrong PCB (do not correspond to the model).	Cycle interrupted.	OFF/ON START
E93	Incorrect configuration data; PCB faulty.	Cycle interrupted.	OFF/ON
E94	Incorrect configuration data; PCB faulty.	Cycle interrupted.	OFF/ON
E95	PCB faulty.	Cycle interrupted.	RESET
E97	Faulty PCB (Wrong configuration data).	Cycle interrupted.	RESET
E98	Incompatibility between main board and Inverter	Cycle interrupted.	OFF/ON
E99	Main PCB.	Cycle interrupted.	OFF/ON
E9B	Display board.	Cycle interrupted.	Reset
E9C	Display board.	Cycle interrupted.	Reset
E9D	Display board.	Cycle interrupted.	Reset
E9F	Main PCB.	Cycle interrupted.	OFF/ON

Alarm	Possible fault	Action/machine status	Reset
EH1	Power supply problems (incorrect / disturbance); PCB faulty.	Wait for frequency nominal conditions.	OFF/ON
EH2	Power supply problems (incorrect / disturbance); PCB faulty.	Wait for voltage nominal conditions.	OFF/ON
EH3	Power supply problems (incorrect / disturbance); PCB faulty.	Wait for voltage nominal conditions.	OFF/ON
EHE	Wiring faulty; PCB faulty.	Safety drain cycle – Cycle stopped with door open.	RESET
EHF	PCB faulty.	Safety drain cycle – Cycle stopped with door open.	RESET
EC1	Solenoid valve faulty/blocked; PCB faulty.	Cycle interrupted with door closed. Drain pump functions always (5 min., then it stops for 5 min. etc.)	RESET
EC3	Wiring faulty; Weight sensor faulty; PCB faulty.	-----	START/RESET
EF1	Drain tube blocked/kinked/too high; Drain filter dirty/blocked.	Warning displayed at the end of cycle (specific LED).	START/RESET
EF2	Excessive detergent dosing; drain tube kinked/blocked; Drain filter dirty/blocked.	Warning displayed after 5 attempts or by the specific LED.	RESET
EF3	Water leaks onto base frame; water control system defective.	Machine drains and cycle stops	ON/OFF RESET
EF4	Tap closed, water pressure too low	-----	RESET
EF5	Final spin phases skipped.	-----	RESET
E00	-----	-----	-----

10.14 Diagram with UNIVERSAL MOTOR EWM2100

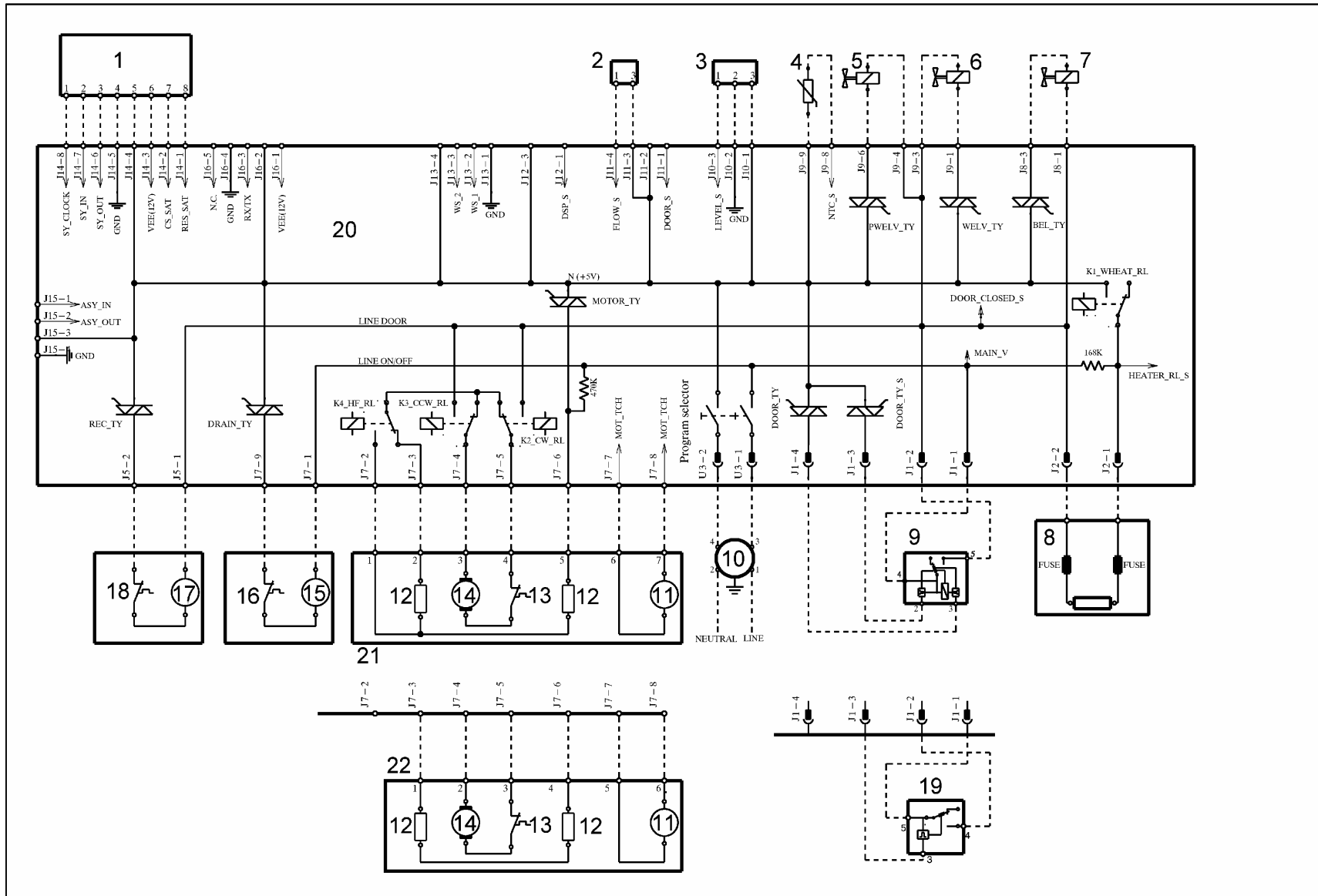

- Key to diagram with UNIVERSAL MOTOR EWM2100

Electrical components on appliance	Components on main board	
1. Display board	DOOR_TY	Door interlock Triac
2. Flowmeter	DRAIN_TY	Drain pump Triac
3. Analogue pressure switch	REC-TY	Recirculation pump Triac
4. NTC temperature sensor	K1	Heating element relay
5. Solenoid valve for prewash	K2	Motor relay: clockwise rotation
6. Solenoid valve for wash	K3	Motor relay: anti-clockwise rotation
7. Solenoid valve for bleach	K4	Motor relay: half field power supply (some models)
8. Heating element (with thermofuses)	MOTOR_TY	Motor Triac
9. Door interlock (instantaneous)	ON/OFF	Main switch (programme selector)
10. Suppressor	PWELV_TY	Pre-wash solenoid Triac
11. Tachometric generator (motor)	WELV_TY	Wash solenoid Triac
12. Stator (motor)	BEL_TY	Bleach solenoid Triac
13. Thermal cut-out (motor)		
14. Rotor (motor)		
15. Drain pump		
16. Thermal cut-out (drain pump)		
17. Recirculation pump		
18. Thermal cut-out (recirculation pump)		
19. Door interlock (with PTC)		
20. PCB		
21. Motor with half field		
22. Motor without field		

10.15 Diagram with THREE-PHASE ASYNCHRONOUS MOTOR EWM2500

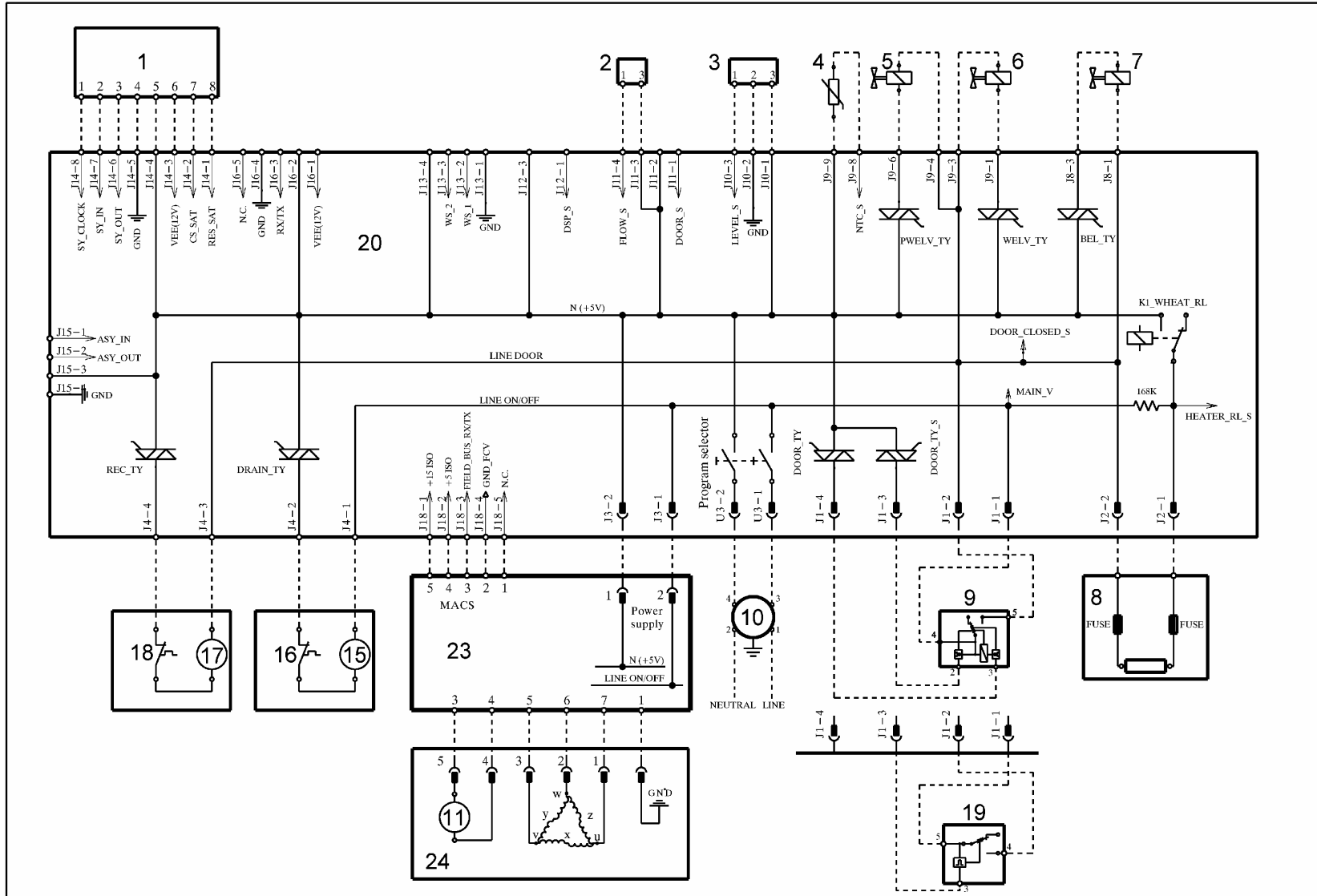

- Key to diagram with THREE-PHASE ASYNCHRONOUS MOTOR EWM2500

Electrical components on appliance	Components on main board	
1. Display board 2. Flowmeter 3. Analogue pressure switch 4. NTC temperature sensor 5. Solenoid valve for prewash 6. Solenoid valve for wash 7. Solenoid valve for bleach 8. Heating element (with thermofuses) 9. Door interlock (instantaneous) 10. Suppressor 15. Drain pump 16. Thermal cut-out (drain pump) 17. Recirculation pump 18. Thermal cut-out (recirculation pump) 19. Door interlock (with PTC) 20. PCB 23. Inverter 24. Three-phase	DOOR_TY DRAIN_TY REC-TY K1 ON/OFF PWELV_TY WELV_TY BEL_TY	Door interlock Triac Drain pump Triac Recirculation pump Triac Heating element relay Main switch (programme selector) Pre-wash solenoid Triac Wash solenoid Triac Bleach solenoid Triac

11 ACCESSIBILITY

11.1 To the electronic control system

11.1.1 Work top

- a. Remove the two rear screws, push the top panel towards the rear and release from the cabinet.

11.1.2 Control panel

- b. Press the drawer lock.
- c. Extract.

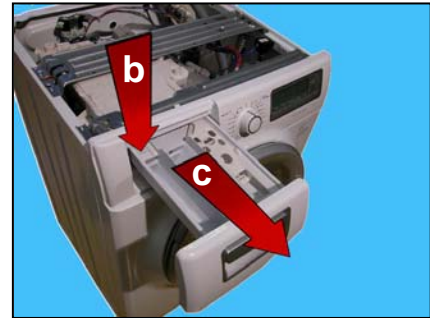

- d. Remove the screw which secures the control panel to the dispenser.



- e. Remove the clamp which secures the wiring to the board casing.

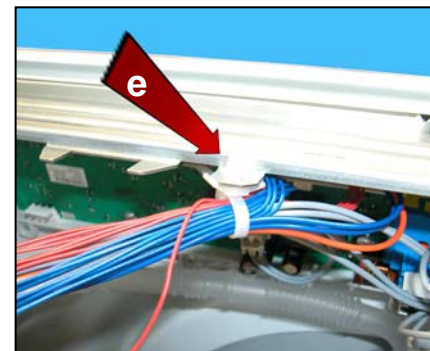

- f. Release the wiring from the clamp under the dispenser.

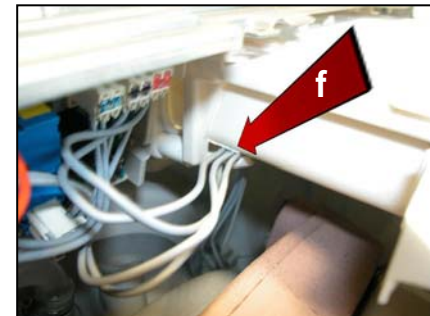

After releasing the wiring from the fixing hooks.

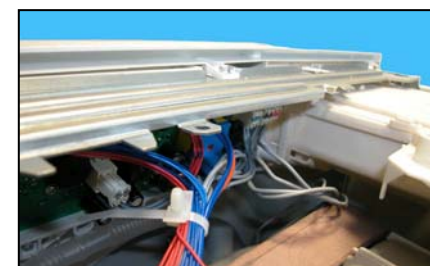

g. Loosen the screws which secure the cross-member to the cabinet.

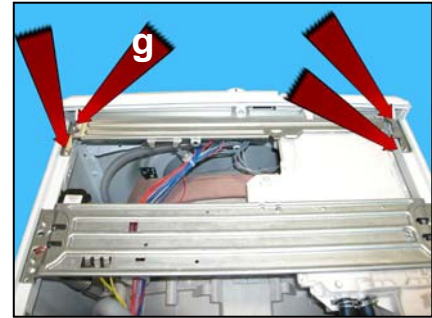

h. Release the hook which secures the dispenser to the cross-member.

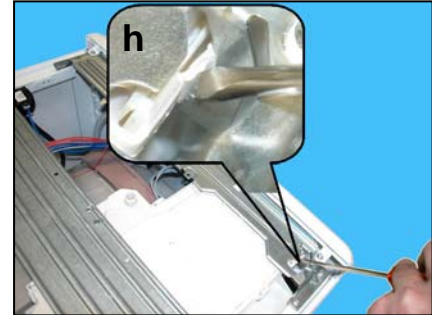

i. Lift the control panel up.



j. Loosen the screws which secure the cross-member to the control panel.

k. Release the hook which secures the control panel to the cross-member.

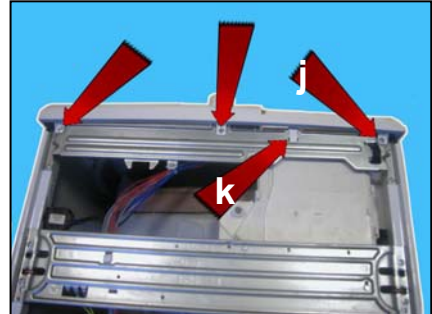

l. Turn and insert a protection between the control panel and the surface which you lean it on to avoid damaging it.

m. To extract the board, remove the screws which secure it to the control panel.

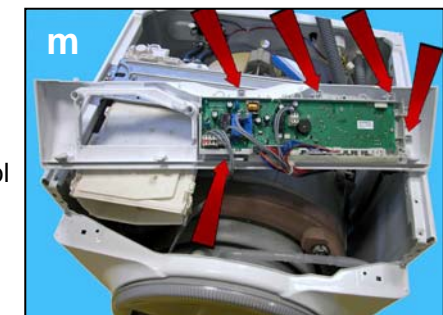

n. To remove the button springing system, release the two hooks which secure it to the main board.



- o. Before mounting the new board extract the knob pushing the hooks indicated by the arrow as represented in figure.

While reassembling, repeat the same operations in reverse order and pay attention to the correct positioning of the knob.

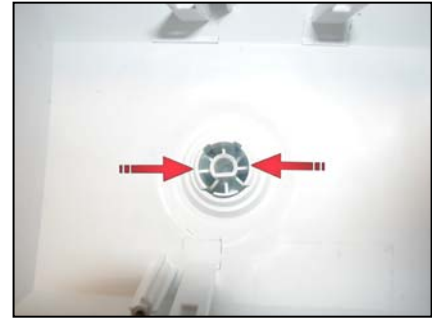

11.2 Door interlock

- a. Remove the ring that secures the bellow gasket to the cabinet.



- b. Remove the bellow gasket.
- c. Remove the screw which secures the door interlock to the front side.
- d. Push inside the hook.
- e. Push it upwards.
- f. Extract the door interlock.

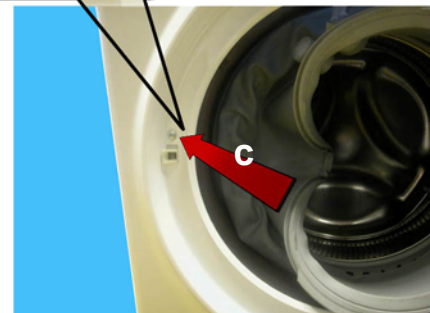
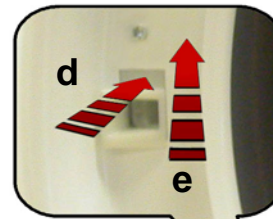

11.3 New drain filter

- a. Open the filter door with the appropriate tool (supplied with the appliance), because it is locked.



To empty the drain circuit:

- b. Remove the cap in the filter knob (after positioning a vessel to collect the water).

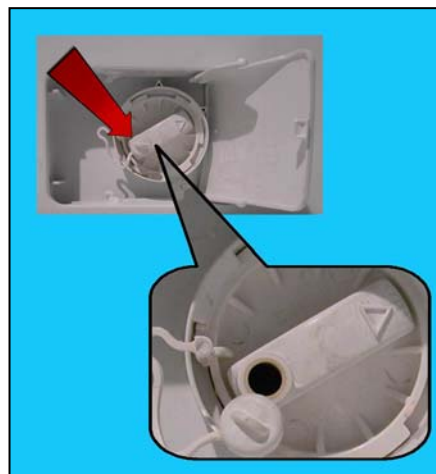

- c. Turn the cap left to align the two references: (the arrow in the cap and the reference point in the filter body), so as to allow extracting the filter.
- d. Extract the filter.

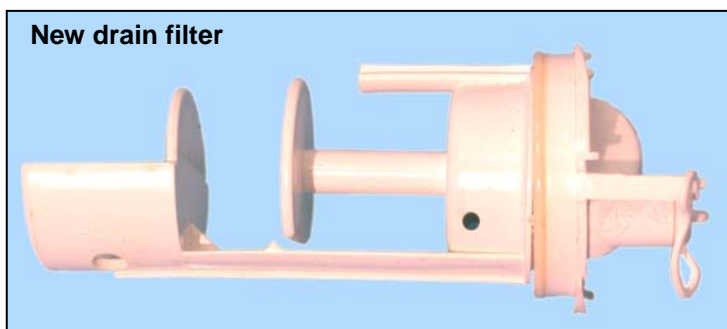

11.4 Inverter board

- a. Release the hook.
- b. Push the hook inside, extract it.
- c. Push the wing which secures the board the cabinet.

