

© ELECTROLUX HOME PRODUCTS
ITALY S.p.A.
Spares Operations Italy
Corso Lino Zanussi, 30
I - 33080 PORCIA /PN (ITALY)

Fax +39 0434 394096

Edition: 2006-04

Publication no.

599 37 82-86

EN

**Dishwasher with
EDW 1500 electronic
control system
(Functionalities)**

DIVA 60 cm
Prod. N. 911 516 xxx
F.S. - Free-standing
Prod. N. 911 526 xxx
B.I. - Partially integrated

Production:
PLV - Zarow (Poland)

CONTENTS

1	Purpose of this manual	5
2	PRECAUTIONS	5
3	GENERAL CHARACTERISTICS	5
4	CONTROL PANEL	6
4.1	Control panel.....	6
4.1.1	ON/OFF button (S0).....	7
4.1.2	Programme/Option buttons (S1-S6).....	7
4.1.3	Indicator LEDs (LD7÷LD12)	7
4.1.4	Display	8
4.2	Options.....	8
4.2.1	“3 in 1 Tablet”	8
4.2.2	Extra rinse (rinse +).....	8
4.2.3	“1/2 load”	8
4.2.4	“Sanitize”	8
4.2.5	Delayed start.....	9
4.3	Modifying a programme	9
4.3.1	Cancelling a programme (reset).....	9
4.3.2	Modifying a programme	10
4.3.3	Interruption of a programme (pause)	10
4.4	Power failure	10
4.5	Buzzer (only certain models)	10
4.6	Sequence of operations	11
5	HIDRAULIC CIRCUIT	12
5.1	Version with short tank	12
5.2	Version with long tank.....	13
6	CARATTERISTICHE COSTRUTTIVE	14
7	ELECTRICAL COMPONENTS AND THEIR FUNCTIONS	15
7.1	EDW1500 Electronic control system	15
7.1.1	Functions of the circuit board	15
7.1.2	Memory in the control system	15
7.2	Specifications for actuators and sensors	16
7.2.1	Components.....	16
7.2.2	Sensors.....	16
7.3	Power supply and programme selection	17
7.4	Fill circuit.....	17
7.4.1	Level and anti-overflow pressure switch	17
7.4.2	Fill system	17
7.4.3	Anti-flooding device.....	17
7.4.4	Intervention of the anti-overflow system.....	17
7.5	Control of water fill phase	17
7.5.1	Static fill	17
7.5.2	Dynamic fill.....	18
7.5.3	Level stability control.....	18
7.6	Water fill time	18
7.6.1	Static fill time.....	18
7.6.2	Dynamic fill time	18
7.6.3	Power supply interruption during water fill	18
7.7	Level stability during washing	18
7.8	Washing system	18
7.8.1	Control of the washing pump	19
7.9	Heating.....	19
7.10	Integrated detergent dispenser	19
7.11	Drain.....	20
7.11.1	Effetto “sifone”.....	20
7.12	Regeneration system	20
7.13	Resin washing	21
7.14	“Blending” function	21
8	Drying.....	21
8.1.1	“Turbo-dry” drying	22
9	Automatic cycle	23
9.1	Turbidity sensor	23
9.1.1	Calculating the degree of soiling.....	23
9.1.2	Determination of the load	23
9.2	Automatic Programme	23

10	Alarms	24
10.1	Table of alarms.....	24
11	USER MODE	26
11.1	Regeneration levels	26
11.2	Rinse aid function.....	27
11.3	Activating/disactivating the buzzer.....	27
12	Diagnostics mode / Options	28
12.1	Accessing diagnostics mode.....	28
12.2	Reading the alarms and activating the individual components.....	28
12.3	Cancelling alarm codes from memory / Testing the LEDs.....	29
12.4	Functional testing cycle.....	29
12.4.1	Selecting the cycle.....	29
12.4.2	Cycle phases	29
12.5	Options available to Service Engineers	30
12.5.1	Selecting the extra cold rinse option	30
12.5.2	Disabling pulse washing	31
12.6	Exiting diagnostics mode	31
13	ELECTRICAL FUNCTIONS.....	32
13.1	Electrical circuit diagram	32
13.2	Basic circuit diagram	33
13.2.1	Key to circuit diagram	33
14	Table of programmes.....	34
15	Checking the efficiency of the components	35
15.1	Measurement points on the board wiring connector	35
16	QUICK GUIDE TO THE SPECIAL FUNCTIONS.....	37

1 Purpose of this manual

The purpose of this Service Manual is to provide Service Engineers, who already have the basic knowledge necessary to repair household dishwashers, with technical information regarding dishwashers featuring the EDW1500 electronic control system. These appliances are manufactured at Zarow (Poland).

The EDW1500 control system consists of a main circuit board and a control/display board. Both boards are housed in a single plastic container.

This system is used in free-standing and partially integrated versions with "DIVA" 60 cm structures.

This Manual describes:

- General characteristics
- Control panel and programmes
- Technical characteristics
- Guide to diagnostics

For more detailed information regarding the hydraulic circuits and the structural characteristics of the appliances, refer to the Service Manual for presentation of the "DIVA" structure.

2 PRECAUTIONS



- **Electrical appliances must be serviced only by qualified Service Engineers.**
- **Always remove the plug from the power socket before touching internal components.**

3 GENERAL CHARACTERISTICS

Power supply	⇒ 230 V / 50 Hz (limits: 187–254 V)
Mains water supply	⇒ Pressure Min. / Max. 5 – 80 N/cm ²
Capacity	⇒ 12 place settings
Consumption (prog. BIO):	
↻ Water	⇒ Lt. 14
↻ Energy	⇒ KWh 0,8
↻ Cycle time	⇒ 162 min
Controls	
- ON/OFF	⇒ Horizontal / Vertical
- Selection of programmes/options	⇒ Two-pole switch (separate from the electronic board)
- Display	⇒ Button-actoned (min. 3, max. 6)
	⇒ Display 2,5 digits and LEDs
Washing system	⇒ Combined / Pulse
Control of water level	⇒ Pressure switch + Software
Water heating	⇒ Tube-enclosed heating element
Temperature control	⇒ NTC temperature sensor
Type of drying	⇒ Active / Turbo
Safety devices / Alarms	⇒ Total protection (hydraulic + Software)

4 CONTROL PANEL

4.1 Control panel

The configuration of the control panel depends on the following:

- Typology of the electronic board:
 - ↳ horizontal buttons
 - ↳ vertical buttons
- Number of programme selection buttons (from a minimum of 3 to a maximum of 6)
- Number of LEDs (max.13)
- Position of the ON/OFF button (right or left)

Version with horizontal buttons

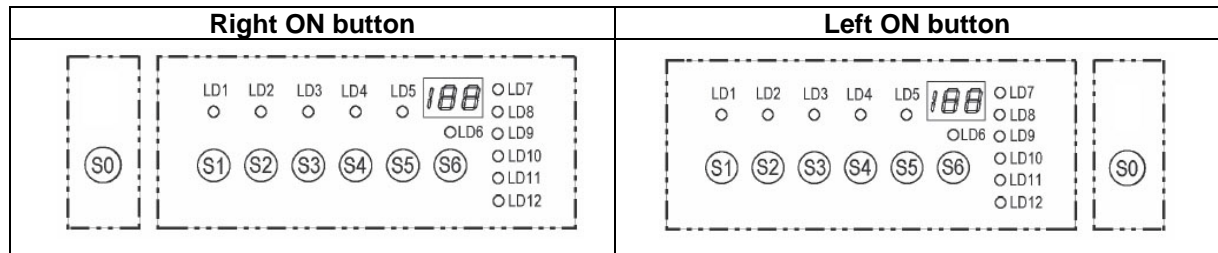

Version with vertical buttons

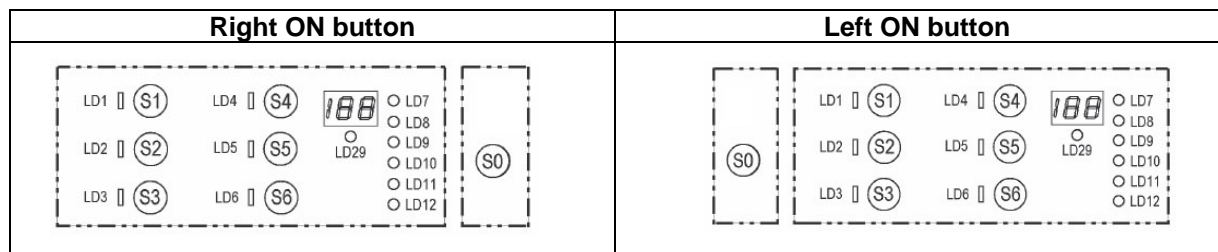
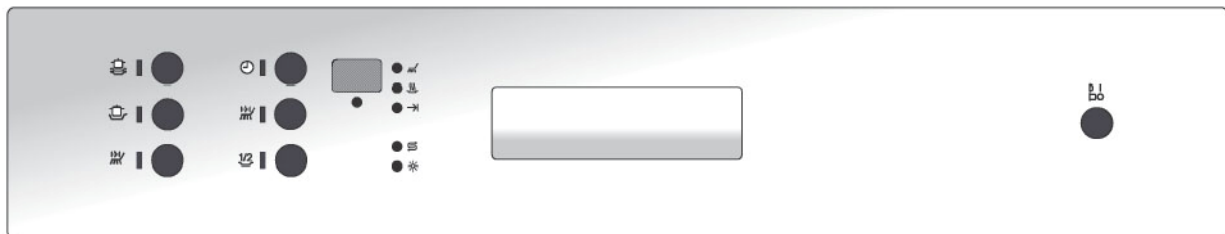

Key

S0	ON/OFF button
S1÷S6	Programme/option selection buttons
LD1÷LD6	Programme/Option indicator LEDs
LD7÷LD12	Indicator LEDs phases / warnings (washing, drying, end of cycle, salt, rinse-aid)

4.1.1 ON/OFF button (S0)

The ON/OFF button is featured on all models in the range, and is used to switch the appliance on and off. Switching off does not cancel the programme being executed.

4.1.2 Programme/Option buttons (S1-S6)

The functions of the various buttons depend exclusively on the software configuration of each appliance, which can feature from 3 to 6 buttons.

Also the selection of the washing programmes changes according to the configuration of each appliance.

The buttons S1, S2, S3 are always featured because perform special functions.

▪ MODELS WITH DIRECT SELECTION

To each button corresponds a specific programme:

1. Close the door and switch the appliance on [S0]
2. Press a button to select a programme:
 - ↪ The relative LED lights.
 - ↪ The display shows the flashing time-to-end.
 - ↪ The indicator LEDs of the phase of the cycle light.
3. Within 3 seconds after the programme selection it is possible to set the eventual option or the delayed start (if available).
4. Automatically, 3 seconds after the last pressure of a button, the cycle starts.
 - ↪ On the display the time-to-end lights steady and the LED of the current phase is on.

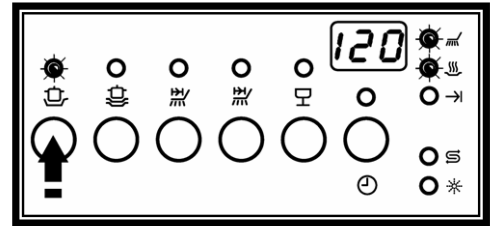

▪ MODELS WITH SEQUENTIAL SELECTION

In these versions two buttons are used to select the programmes:

1. Close the door and switch the appliance on [S0]
 - ↪ The display shows [--]
2. Press button [+ →] to select with an increasing order:
 - ↪ The LEDs relative to the programme buttons light (if featured).
 - ↪ The display shows the last selected flashing programme. Every time the button is pressed the following programme is selected (increasingly): ↪ 1 ↪ 2 ↪ 3.....
3. Press button [- ←] to select with a decreasing order:
 - ↪ The LEDs relative to the programme buttons light (if featured).
 - ↪ The display shows the last selected flashing programme. Every time the button is pressed the previous programme is selected: ↪ 7 ↪ 6 ↪ 5.....
4. Within 3 seconds after the programme selection it is possible to set the possible option or the delayed start (if available).
5. Automatically, 3 seconds after the last pressure of a button, the cycle starts.
 - ↪ The digits and the LED indicating the current phase are on.

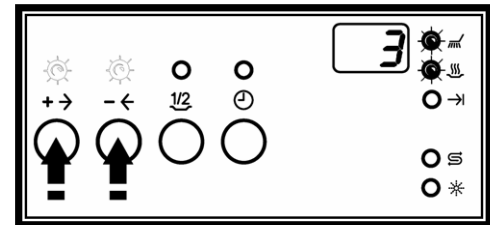

4.1.3 Indicator LEDs (LD7÷LD12)

The functionalities of the LEDs depend on the configuration software of each appliance.

●	Washing: lights when the washing phase is performed and during the selection (if featured).
●	Drying: lights when the drying phase is performed and during the selection (if featured).
●	End of cycle: lights when the programmes ended.
●	Salt: indicates that the salt reservoir is empty. If the level of regeneration is set to "1" (no regeneration), this LED remains unlit at all times.
●	Rinse-aid: indicates that the rinse-aid reservoir is empty.

4.1.4 Display

The display, which consists of 2,5 digits, can indicate:

- ⇒ The indicative time-to-end of the programme in minute. The countdown is carried out every minute and updated at the end of each programme phase (when the programme is updated it can decrease by more minutes at a time or stop for longer).
- ⇒ The end of cycle [0]
- ⇒ The possible delayed start time in hours (max 19h); the time decreases every hour.
- ⇒ The selected regeneration level (during the regulation).
- ⇒ A possible alarm code in case of failure.
- ⇒ The condition of the special functions (no rinse-aid and).
- ⇒ The condition of the functions that the Service can select.



4.2 Options

4.2.1 “3 in 1 Tablet”

This option can be selected by pressing the corresponding button, and remains in memory until the same button is pressed again. This option modifies the phases of the programme in order to optimize performance when “3 in 1” detergent tablets are used:

- ↵ variation of the duration of the programme and the temperatures required to dissolve the detergent tablets.
- ↵ reduction of water exchange (partial drain phases)
- ↵ exclusion of introduction of rinse-aid
- ↵ exclusion of regeneration / resin washing

4.2.2 Extra rinse (rinse +)

This option may be selected temporarily by pressing the button (if featured), or in “Service” mode. If this option is set by the service engineer, it remains in memory until deactivated (see relative section).

- ↵ This option adds one cold rinse (with pulse washing) with a duration of about 5 minutes.

4.2.3 “1/2 load”

The 1/2 load option optimizes the washing cycle when only a small load is placed in the appliance.

• 1/2 load button

When this button is pressed, certain parameters of the selected washing cycle are modified:

- ↵ Exclusion of Pre-wash (if featured)
- ↵ Reduction of the washing temperature
- ↵ Reduction of the duration of the programme (up to 36 minutes)

• Automatic 1/2 load

When this button is not featured on the control panel, certain programmes may feature automatic detection of the half load. This system measures variations in the temperature during the initial heating phase. The temperature and the duration of the wash are both reduced.

This option is not available in the following cycles: “Intensive”, “Short 30 minutes”, “Soak”, “Heating plates” and “Glassware”.

4.2.4 “Sanitize”

This is a special option used to sanitize the dishes/cutlery. However, it is NOT compatible with the “Glassware” programme.

- ↵ During the final rinse, the temperature is maintained at 68°C for 10 minutes.
- ↵ If used together with the SOAK option, the system performs a special sanitizing programme which lasts approximately 46 minutes (1 hot rinse followed by 10 minutes at a constant temperature of 68°C)

4.2.5 Delayed start

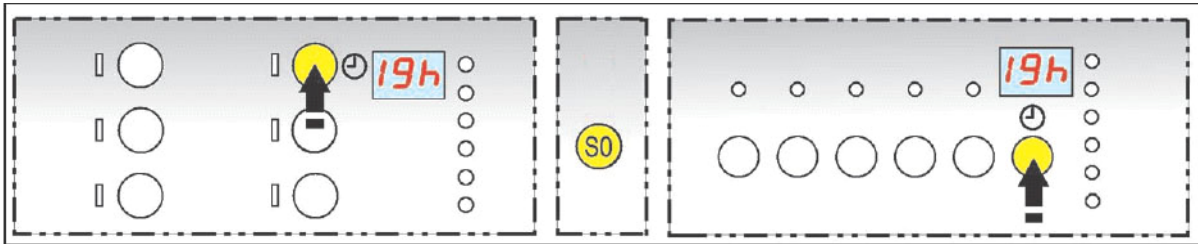

Proceed as follows to select the delayed-start time:

1. Close the door and switch the appliance on by means of the S0 button.
2. Press the button repeatedly to select the delayed-start time which appears flashing on the display.
↪ The time increases every hour up to 19h [1 2 3 19 0..].
3. Select the programme and the possible options.
↪ For some seconds the display shows the time-to-end of the cycle, then the delay time.
4. 3 seconds after the last selection, the delay time is activated.
↪ The display lights steady and the countdown starts: the time decreases every hour [19 ⇒ 18 ⇒ 17... ⇒ 1 ⇒ 0].
5. During the countdown, till the programme starts, it is possible to modify the delay time or cancel it.
6. the programme starts automatically.
↪ The display shows the time-to-end of the cycle.

The delayed-start countdown can also be selected as follows:

1. Press button S0 to switch on the appliance.
2. Select the programme and the possible options.
3. Within 3 seconds, press sequentially the button to select the delay time.
4. 3 seconds after the selection the delay time and the countdown start with the same modalities previously described.

4.3 Modifying a programme

4.3.1 Cancelling a programme (reset)

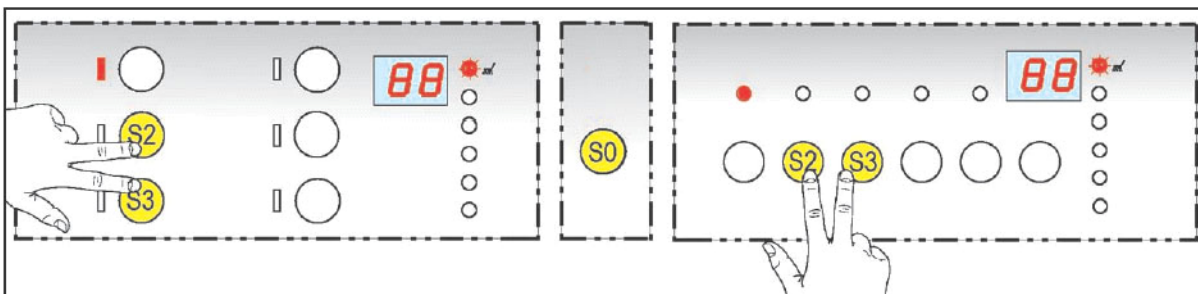

To cancel a programme that has already started, proceed as follows:

1. Open the door carefully and press buttons **S2** - **S3** together for approximately 2 seconds: the LED corresponding to the cycle being executed begins to flash.
2. After about two seconds, all the LEDs and the display switch off: the programme is now cancelled and the appliance returns to the selection mode.

4.3.2 Modifying a programme

1. Until a cycle has actually started (digit with flashing light), the settings selected can be modified at any time by pressing the appropriate buttons.
2. To modify a programme that has already started, first cancel it (see corresponding parag) and then perform the new selections.

or:

1. Press the button of the new programme for about 6 seconds, the LED of the current programme begins to flash.
2. After about 6 seconds the LED of the old programme switches off and the LED of the new one lights: the possible options are deleted and have to be selected again.

4.3.3 Interruption of a programme (pause)

Proceed as follows to interrupt a programme that has already started:

1. Press **S0** to switch the appliance off.
2. To re-start the cycle, press **S0** again: The programme starts from the point at which it was interrupted.
3. If you open the door the cycle interrupts: re-closing it, the programme starts (after a brief delay) from the point at which it was interrupted.

Important! If the appliance is switched off or if the door is opened for more than 30 seconds during the drying phase, the cycle is considered to have been terminated after the regeneration phase; when the appliance is switched on again, it returns to programme selection mode.

4.4 Power failure

The Power Failure function maintains the information relative to the cycle status even in the even of a power outage; when the power supply is restored, the cycle resumes from the point at which it was interrupted.

If the power failure occurs during the drying phase, the cycle is considered to have been terminated after the regeneration phase.







4.5 Buzzer (only certain models)

Normally this series of appliances does not feature the buzzer, but some models do.

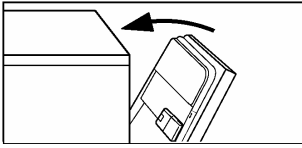
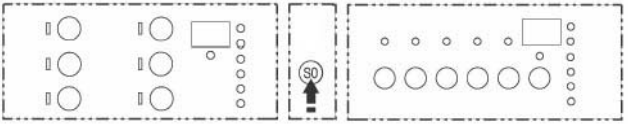
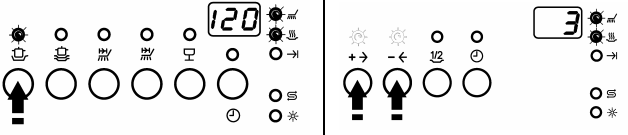
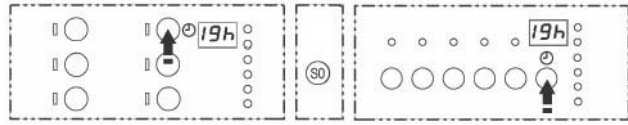
The buzzer sounds to indicate the **end of cycle** and in the event of an **alarm condition**.

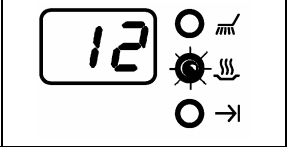
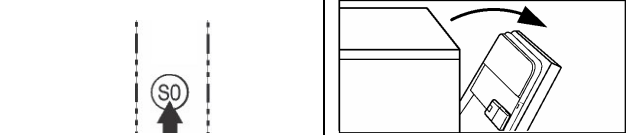
The buzzer sounds three times at the end of the cycle, but switches off immediately if the door is opened. If the user prefers to switch off the buzzer, it is necessary to press a combination of buttons.

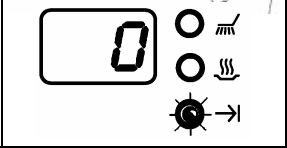
4.6 Sequence of operations

SELECTING THE CYCLE	1. Close the door.	
	↖ Press S0 to switch the appliance on	
	2. Select the desired programme. ↖ The display shows the time-to-end or the programme no. flashing. ↖ The phase LEDs light up.	
3. Within 3 seconds select the possible delayed start or the desired option (if featured)		
START	4. Automatically, 3 seconds after the last pressure of a button, the cycle starts. ↖ The digits and the current phase LED light steady.	
EXECUTION OF THE CYCLE	5. The time-to-end decreases every minute and is updated after every cycle phase. ↖ The LED indicates the current phase.	
	6. To interrupt a current programme: ↖ Switch the appliance off with S0 (or open the door) ↖ To start it again, press S0 (and close the door)	
	7. To cancel a current programme: ↖ Press S2 – S3 simultaneously for about 2 seconds.	
END	8. At the end of the programme: ↖ The buzzer sounds at intervals. ↖ The END OF CYCLE LED lights. ↖ The display shows [0].	
	9. Press S0 to switch the appliance off.	

5 HIDRAULIC CIRCUIT

5.1 Version with short tank

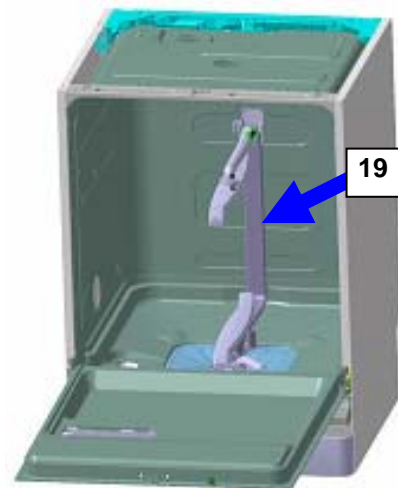
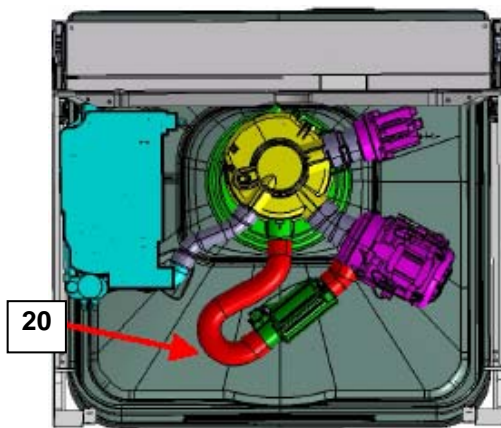
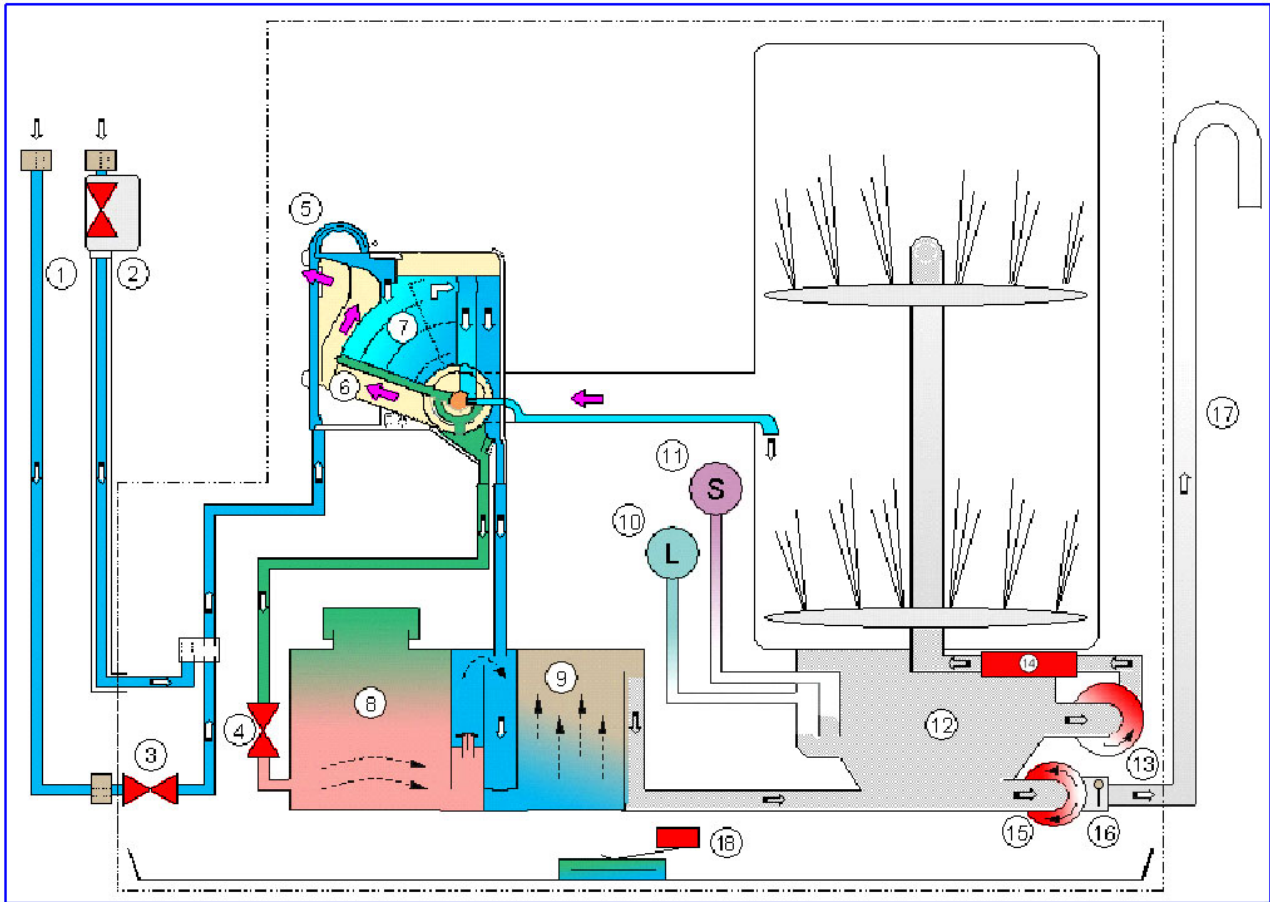

KEY

1 - Fill hose	11 - Anti-overflow pressure switch
2 - Fill hose with Acquacontrol	12 - Sump assembly
3 - Fill solenoid	13 - Wash pump
4 - Regeneration solenoid	14 - Tube-enclosed heating element
5 - Air-Break	15 - Drain pump
6 - Steam condenser	16 - Non-return valve
7 - Regeneration chamber	17 - Drain hose
8 - Salt Reservoir	18 - Anti-flooding device
9 - Resin Reservoir	19 - Upper spray arm duct
10 - Level pressure switch	20 - "Heating element to spray arms duct" hose

5.2 Version with long tank

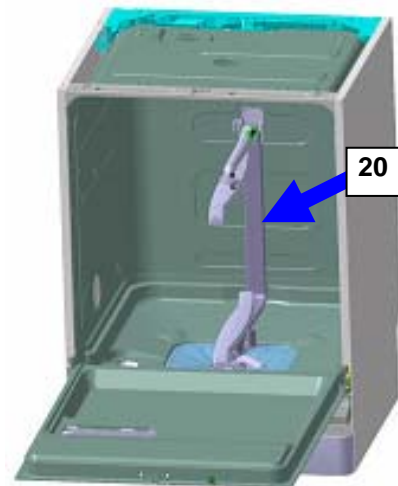
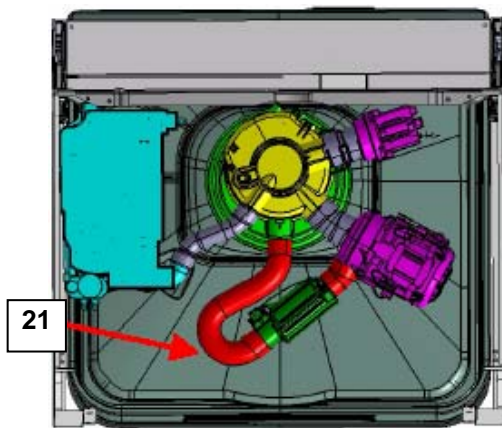
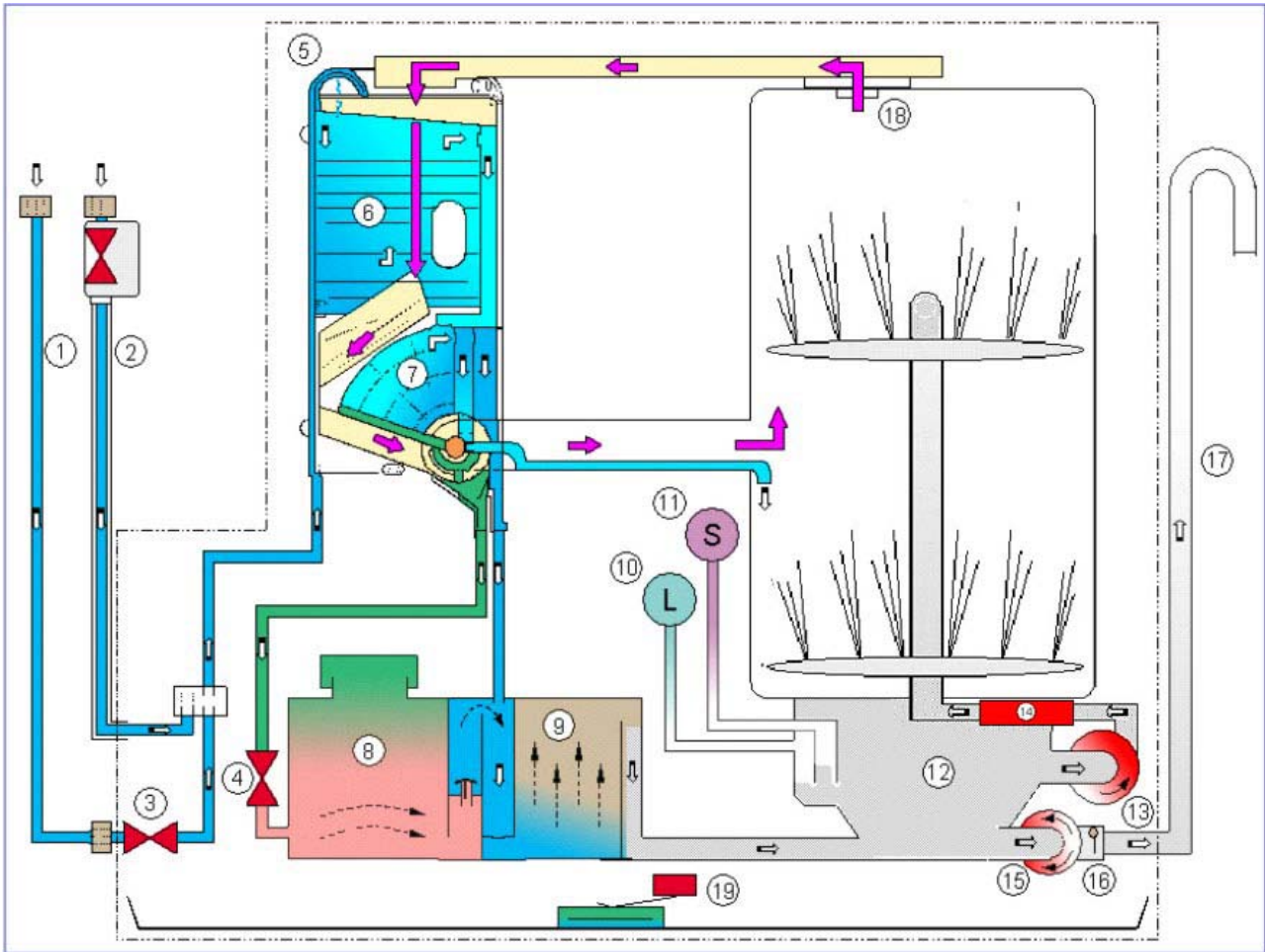

KEY

1 - Fill hose	11 - Anti-overflow pressure switch
2 - Fill hose with Acquacontrol	12 - Sump assembly
3 - Fill solenoid	13 - Wash pump
4 - Regeneration solenoid	14 - Tube-enclosed heating element
5 - Air-Break	15 - Drain pump
6 - Steam condenser	16 - Non-return valve
7 - Regeneration chamber	17 - Drain hose
8 - Salt Reservoir	18 - Drying duct / fan
9 - Resin Reservoir	19 - Anti-flooding device
10 - Level pressure switch	20 - Upper spray arm duct
	21 - "Heating element to spray arms duct" hose

6 STRUCTURAL CHARACTERISTICS

This range of dishwashers, compared to the previous version, has a simplified hydraulic circuit, a new plinth (structural and aesthetical part) and side panels as shown in the following pictures:

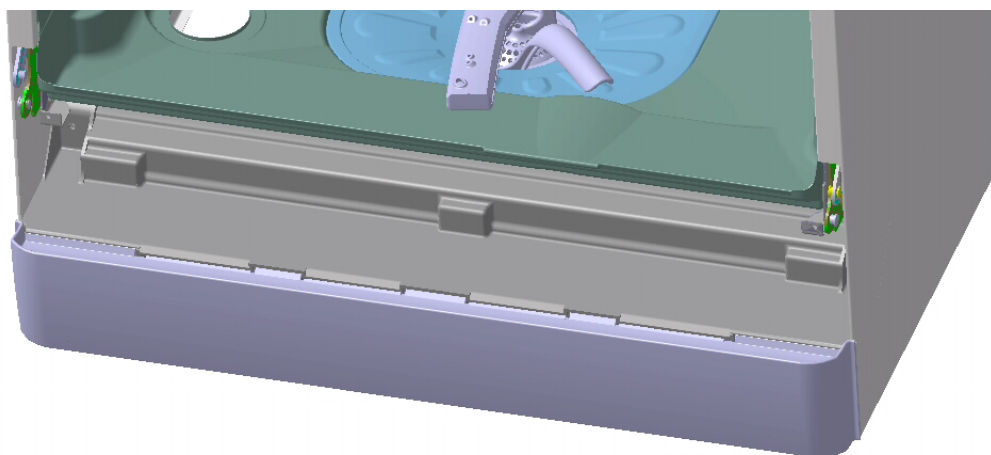
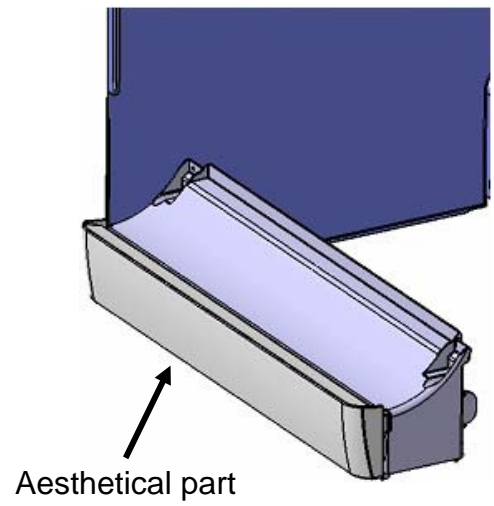
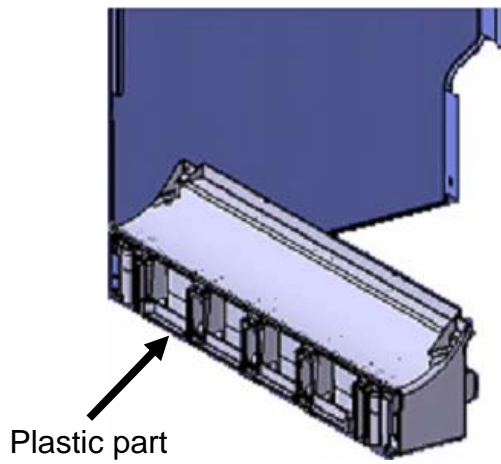
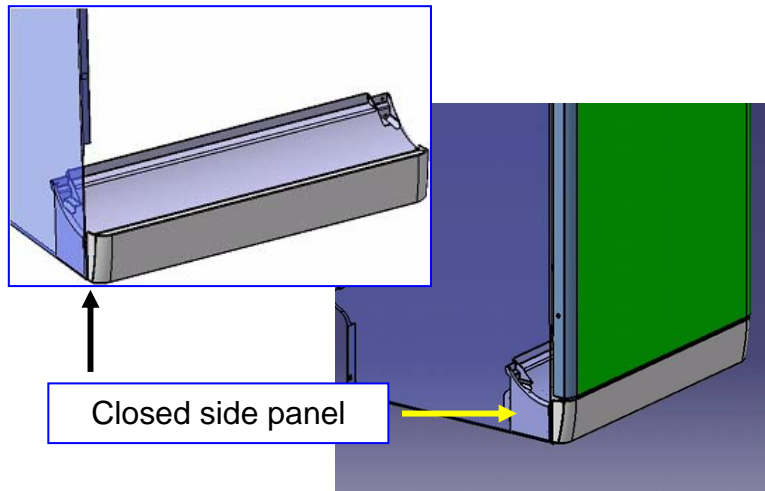

7 ELECTRICAL COMPONENTS AND THEIR FUNCTIONS

7.1 EDW1500 Electronic control system

The EDW1500 control system consists of a main circuit board and a control/display board. Both boards are housed in a plastic container.

Version with horizontal buttons



Version with vertical buttons



7.1.1 Functions of the circuit board

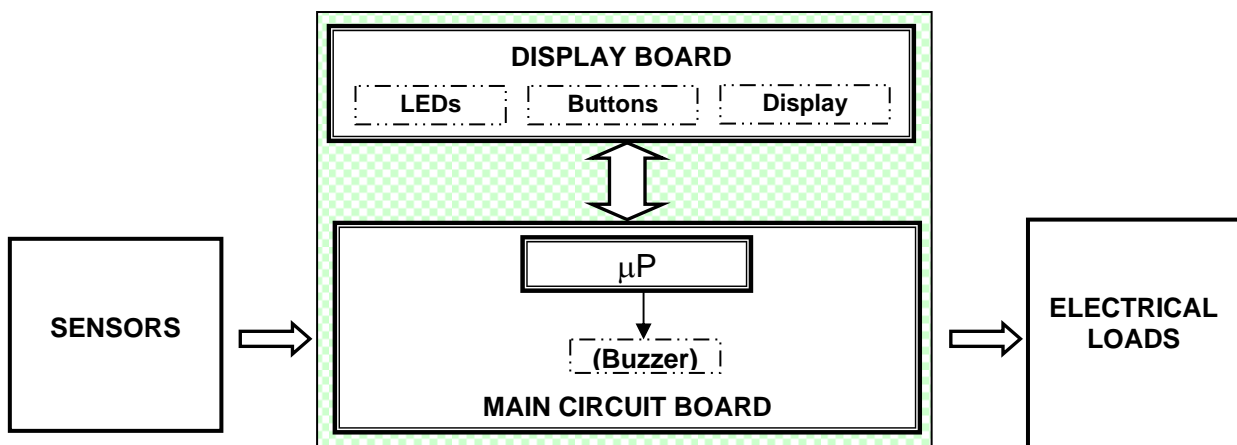

- ⇒ The circuit board receives signals relative to the cycle settings via the control/display board. The buttons and LEDs are also mounted on this board.
- ⇒ The board also powers all the electrical components (solenoid valves, washing pump, detergent/rinse-aid dispenser, drain pump, heating element, fan motor).
- ⇒ The board controls the temperature of the washing water via an NTC sensor, as well as the speed of rotation of the washing pump according to the signal received from the tachometric generator.
- ⇒ The circuit board monitors the status of the pressure switch and the rinse-aid/salt sensors.

7.1.2 Memory in the control system

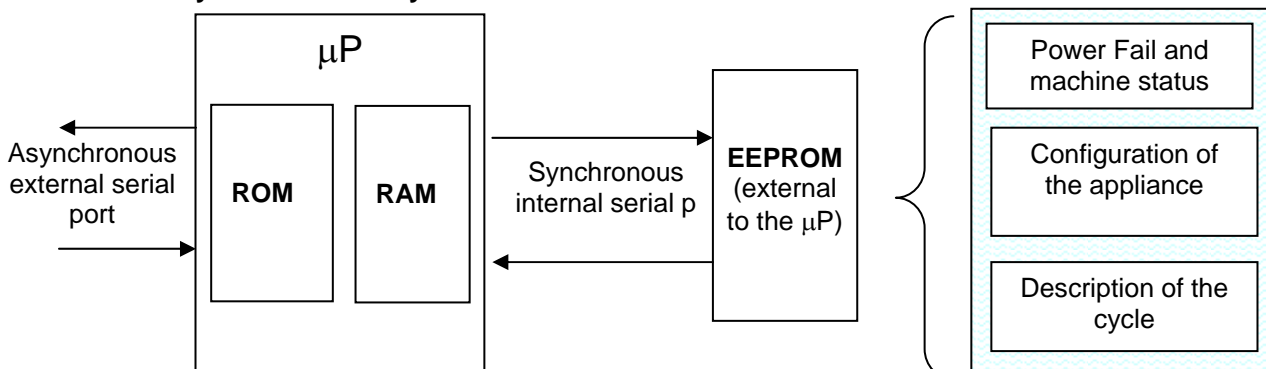

The main circuit board features an EEPROM memory (external to the microprocessor) which stores in memory data relative to the configuration, description of the cycle, cycle status in case of a power failure, and any alarm conditions.

The configuration data (entered in the factory using a computer with a DAAS interface) determine the functionalities of the appliance (number and type of programmes, options, LEDs etc.).

7.2 Specifications for actuators and sensors

7.2.1 Components

TYPE OF COMPONENT	POWER AVAILABLE	TYPE OF ELECTRONIC CONTROL
Wash pump	Max 250W	Triac
Drain pump	Max 100W	Triac
Heating element	Max 2100W	Relay
Water fill solenoid	Max 10W	Triac
Regeneration solenoid	Max 10W	Triac
Detergent and Rinse-aid solenoid	Max 10W	Triac
Fan motor	Max 10W	Triac

7.2.2 Sensors

TYPE OF SENSOR	TYPE OF ELECTRONIC SIGNAL	TYPE OF COMPONENT
Salt sensor	Digital 5 Volt	Reed
Rinse-aid sensor	Digital 5 Volt	Reed
Temperature sensor	Analogue 5 Volt	* NTC
Turbidity sensor (certain models only)	Analogue 5 Volt	Opto-electronic
Tachometric sensor	Frequency	Tachometric generator
Level sensor	Digital - High voltage	Pressure switch
Door closure sensor	Digital - High voltage	Switch
Anti-flooding sensor	Digital - High voltage	Switch

* NTC Temperature sensor

* <u>NTC</u> COMPARATIVE VALUES		
Temperature °C	⇒	Nominal value Ω
10	⇒	9655
25	⇒	4850
60	⇒	1205
90	⇒	445

7.3 Power supply and programme selection

The main board is powered by the closure of contacts 1-3 and 2-4 of the ON/OFF button (PU). The connectors used in this case are A2 (neutral) and B1 (line).

The control/display board (user interface) is powered at 5V by the main board, making programme selection possible.

When the door is closed, the main board detects the closure of the contacts of the switch (IP) across connectors B2-D1, and starts the washing programme. The same switch powers the electrical components.

When the door is opened, the power loads are disconnected from the power supply and the cycle is paused.

7.4 Fill circuit

7.4.1 Level and anti-overflow pressure switch

- The level of water introduced into the appliance is determined by the level pressure switch
- The anti-overflow pressure switch ensures that the level of water does not exceed the safety threshold (causing overflow from the door).

7.4.2 Fill system

The water fill solenoid valve is powered by triac TY2 on the electronic board (connector C7), by the door switch (IP) and by the anti-flooding microswitch (DA).

The level of water in the sump is monitored by the pressure switch (RL). The electronic board constantly monitors the status of the pressure switch via a "sensing" line connected to connector C5:

- ⇒ EMPTY if the contacts are closed on 1-2
- ⇒ FULL if the contacts are closed on 1-3

7.4.3 Anti-flooding device

Intervention of the anti-flooding device causes the contacts of the microswitch (DA) to open, thus disconnecting the solenoid valve from the power supply.

7.4.4 Intervention of the anti-overflow system

If the anti-overflow pressure switch (PA) should intervene, the closure of the contact on FULL (1-3) powers the drain pump (PS). The pump remains in operation until the contact returns to EMPTY (1-2).



If the door is opened or the appliance is switched off, the drain pump is deactivated.

7.5 Control of water fill phase

The quantity of water necessary to carry out the washing cycle is determined exclusively by the closure of the electrical contact of the pressure switch, which changes from EMPTY to FULL. This system ensures that, if the pressure switch re-opens on EMPTY, further water is introduced until it returns to FULL. The water fill phase consists of the following sub-phases:

7.5.1 Static fill

With the motor switched off, the fill solenoid valve is energized and water is introduced into the appliance until the pressure switch signal switches to FULL.

7.5.2 Dynamic fill

The dynamic fill is obtained by switching on the washing pump whose rotation causes the pressure switch to switch to EMPTY. Subsequently, the fill solenoid valve is energized and water is introduced until the switch returns to FULL.

The speed of rotation of the motor determines the quantity of water introduced, since the electronic control system switches on the washing pump at a variable speed which depends on the washing system that will be performed in the phases subsequent to the water fill:

- ⇒ In the case of "ctrl" washing (at constant speed), the speed of rotation increases gradually to **2800 rpm**
- ⇒ In the case of "pw" (pulse) washing, the speed of rotation increases gradually to **1900 rpm**

N.B.- Refer to the Table of Programmes for the definition of the washing system.

7.5.3 Level stability control

The hydraulic circuit operates with maximum efficiency when the pressure switch signal remains stable on FULL. In practise, the quantity of water circulating in the sump allows the motor to run without speed fluctuations caused by cavitation.

When the pressure switch signals FULL, the fill solenoid valve switches off.

7.6 Water fill time

The aperture of the solenoid valve has a pre-set overall duration, which is subdivided into the various sub-phases of the fill:

7.6.1 Static fill time

T.S. = max 120 seconds: This is the maximum time within which the pressure switch must switch to FULL. If the FULL signal is not received from the pressure switch within this time, the electronic control system interrupts the washing cycle and the appliance enters alarm condition [**1 0**].

7.6.2 Dynamic fill time

T.D. = T.S. x 3: This is the maximum time allowed for the entire fill phase within which the pressure switch signal must stabilize on FULL.

- If the pressure switch signal does not stabilize on FULL within this period (T.S. x 3), the electronic control system switches off the fill solenoid (and the heating element, if switched on), and then allows the washing cycle to proceed until it is completed. In this situation, the alarm condition [**iF0**] is not displayed to the user, but may be accessed by the Service Engineer using a specific procedure.
- If, during a 2600 rpm dynamic fill, the pressure switch never closes on FULL during the initial 60 seconds, the electronic control system interrupts the washing cycle and the appliance enters alarm condition [**i10**].

7.6.3 Power supply interruption during water fill

If the water fill phase is interrupted by opening the door or due to a power failure, the contents of the counters are stored in memory; when the door is re-closed or when the power supply is restored, the water fill resumes from the point at which it was interrupted; the new counter values are added to those previously memorized.

7.7 Level stability during washing

Once the fill phase has been completed, the cycle proceeds to the washing phase. The washing phase is carried out using cold or heated water, and the status of the pressure switch is monitored constantly to ensure that the hydraulic system functions correctly. Water replenishment cycles may be performed if necessary.

If the pressure switch returns to EMPTY during the washing phase, the fill solenoid is energized for a maximum time equivalent to **T.S. x 3** (maximum allowable total fill time).

If this time is exceeded, the washing cycle is completed, but no further supplementary fills are performed. In this situation, alarm condition [**iF 0**] is stored in memory. This alarm code is not displayed to the user, but can be accessed by the Service Engineer using a specific procedure.

7.8 Washing system

The appliance features the classic washing system in which the mechanical washing action is obtained by the rotation of the washing pump which, by ducting water into the hydraulic circuit, actions the two spray arms simultaneously.

The washing pump is actioned by an asynchronous motor with a start-up capacitor (3 μ F - 450VL). The washing pump rotates in a counter-clockwise direction (seen from the impeller side) and is fitted with a tachometric generator.

In order to optimize the washing programmes, two washing systems can be applied:

- “ctrl” \Rightarrow Washing at constant speed (2800 rpm) (maximum speed of the motor).
- “pw” \Rightarrow Pulse washing at 1600 - 2800 rpm. This washing system is controlled by the electronic control system, which actions the washing pump alternately at two speeds (minimum and maximum speed) for short periods.

MOTOR SPEED		PERIOD OF OPERATION	
Maintenance	1600 rpm	\Rightarrow	4 sec
PW1 Pulses	2800 rpm	\Rightarrow	0.8 sec

The **ctrl** and **pw** speeds are configurable. For further details, refer to the cycles tables relative to the specific model.

7.8.1 Control of the washing pump

The washing pump (PL) is powered by triac TY4 on the circuit board (connector C3), by the door switch (IP) and by the ON/OFF switch (PU). The main circuit board controls the speed of rotation according to the signal received from the tachometric generator (T) connected to connectors E1-E2.

This signal is used for:

- \Rightarrow Control of the washing system (**ctrl** or **pw**)
- \Rightarrow Control of the pump motor safety devices and the relative alarms
- \Rightarrow Control of the dynamic fill

7.9 Heating

The heating element is enclosed in a protective tube, and is used to heat the washing water (but does not switch on during the drying phase) The heating element is fitted to the outlet of the washing pump and connected to the duct which feeds the upper spray arm.

The heating element (RR) is powered by relay RL1 on the circuit board (connector A1), by the ON/OFF switch (PU) and by the level pressure switch (RL), which must be set to “FULL” (contact closed on 1-3).

Two safety thermostats are fitted to the heating element:

- an automatic-reset thermostat which intervenes at 98°C
- a thermostat with a thermal fuse (206°C).

The temperature of the water is controlled by the main circuit board via an NTC sensor (ST) which is connected to connectors G5-G6.

7.10 Integrated detergent dispenser

The detergent dispenser is a plastic container consisting of two separate sections. The first (**A**) contains the detergent; the second (**B**) contains the Rinse-aid.

The dispenser is of the single-coil type, and uses a single electrical coil, connected to a mechanical system, for both functions.

When the coil is energized, it actions the mechanism via a series of levers to introduce detergent in a determined sequence (first detergent, then rinse-aid).

The coil of the detergent dispenser (DD) is powered by the circuit board via triac TY5 (connector D7) at certain points during the cycle, thus ensuring correct dosage.

The circuit is closed by the contacts of the ON/OFF switch (PU) and the door switch (IP).

Some models feature a rinse-aid sensor whose reed contact (SB) is connected to connectors F3-F4 on the circuit board.

The absence of rinse-aid causes the contact to close, which lights the corresponding LED (on the display board).

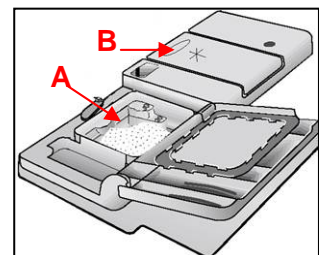

7.11 Drain

The drain pump (PS) is powered by triac TY3 (connector C1) and via the contacts of the ON/OFF switch (PU) and the door switch (IP).

At the end of the drain phase, a control procedure is performed to check that the contact of the level pressure switch is open on EMPTY. If this is the case, the appliance proceeds to the subsequent phase.

If, as a result of a problem in the drain phase, the pressure switch contact remains closed on FULL (i.e. if there is water in the hydraulic circuit), the drain phase is repeated.

On completion of this second drain phase, the status of the pressure switch is again checked. If it is still closed on FULL, alarm **[i20]** is generated (failure to drain).

The time-out for each of these two phases is 120 seconds.

N.B. The washing programmes always begin with a drain phase.

7.11.1 “Siphon” effect

If the drain tube is incorrectly positioned, the so-called “siphon effect” may occur, in which case an alarm is displayed **iF0**.

The problem is particularly likely to occur during execution of the “declaration cycle”: although the drain pump shuts down at the end of the (partial) drain phase, water continues to be expelled from the machine because the drain tube is incorrectly positioned. When this occurs, water loaded by the fill solenoid during the next phase is directly expelled, so the “full contact” on the pressure switch does not close before its “time out”.

Thus, if alarm **iF0** occurs, it is a good idea to make sure the drain tube is correctly positioned as shown in the instruction manual.

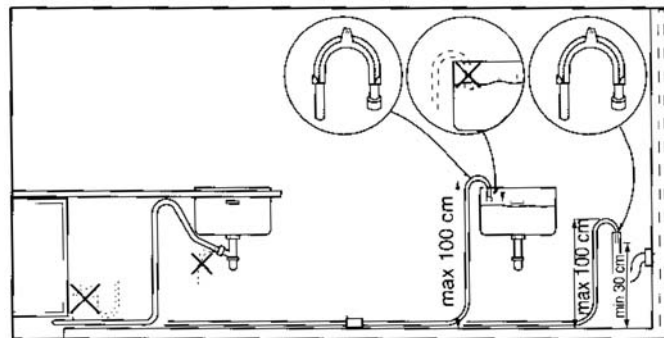

7.12 Regeneration system

Regeneration of the softening system, whose duration is approximately 4 minutes, is normally performed at the beginning of the drying phase.

Each time regeneration is performed (the regeneration solenoid is energized), the chamber is completely emptied (about 230 cc of water).

Regeneration is controlled by the electronic control system “Ad Hoc”, i.e. not at each washing cycle, but rather at intervals determined by the level of regeneration selected.

- ↪ If level **[1]** is selected, regeneration is never performed and the SALT LED (if featured) always remains unlit.
- ↪ If level **[10]** is selected, regeneration is performed twice during each cycle; first at the end of the washing phase, and then at the beginning of the drying phase.

The regeneration solenoid (ER) is powered by triac TY1 (connector C9 on the circuit board) and by the contacts of the ON/OFF switch (PU) and the door switch (IP).

Some models feature a salt sensor whose reed contact (SS) is connected to connectors F1-F2 on the circuit board.

The absence of salt causes the contact to close, which lights the corresponding LED (on the display board).

7.13 Resin washing

Washing of the resins contained in the softening system is performed at the beginning of each washing cycle. In practise, the solution of salty water (regeneration water) remains deposited in the resin container from the end of the last completed cycle until the subsequent cycle.

If the regeneration level is set to **[10]**, washing of the resins is performed once at the beginning of the washing cycle and then again immediately after the regeneration process performed at the end of the washing phase.

The regeneration sequence is as follows:

- a. Drain (30 seconds)
- b. Water fill to correct level
- c. Drain (10 seconds)
- d. Water fill (15 seconds)
- e. Complete drain

7.14 “Blending” function

This function is performed inside the fill tank during the water fill phase which, depending on the position of the selector, automatically blends the softened water with the unsoftened water present in the appliance.

In practice, the softened water is introduced into the appliance through the softening system, while the unsoftened water flows via an open by-pass duct directly through the steam venting ring.

If the level of regeneration is set to between **1** and **4**, it is advisable to activate the BLENDING function to mix softened water with unsoftened water.

This function optimizes the consumption of salt thus preventing the possibility of corrosion of glass recipients due to excessively soft water.

When the BLENDING function is activated, the percentage of unsoftened water introduced into the dishwasher is **15%**.

The BLENDING function is activated using the selector knob located inside the tub, on the left side, in the vicinity of the steam venting grille.

Position of selector

- ⇒ pos.1 = blending ACTIVATED.
- ⇒ pos.2 = blending DISACTIVATED.

8 Drying

In these dishwashers, the dishes are dried by means of a steam condensation process. The drying system is based on the circulation of the hot air produced during the hot rinse.

In dishwashers with a “Normal” drying, the steam produced during the hot rinse enters from the hole on the top of the tub and, after condensing in the air chamber, through the connected hose it deposits in the side part of the base, from which it evaporates naturally (see fig).

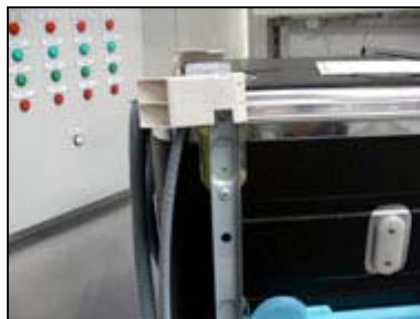

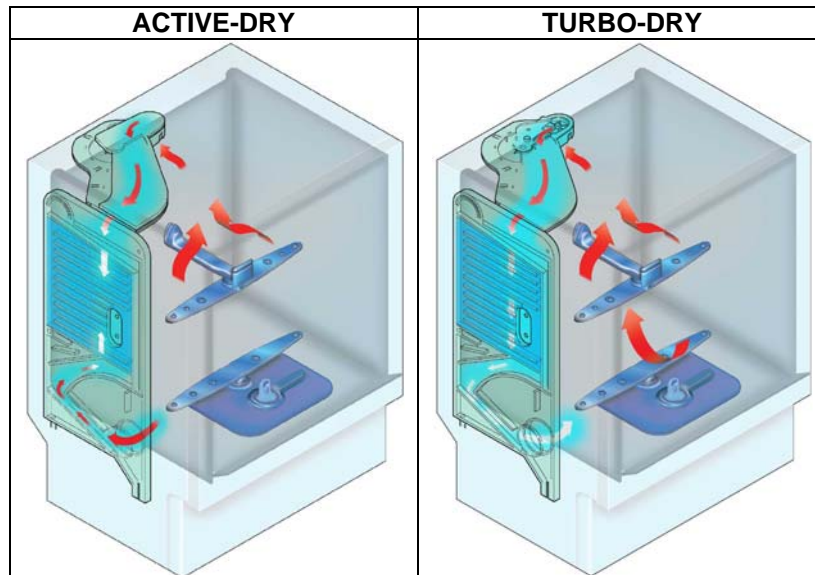

8.1.1 “Turbo-dry” drying

Certain models feature a forced-air drying system.

The steam is drawn in by the fan located inside the upper duct and routed towards the condenser in the fill tank, from which it returns to the tub through the steam venting ring.

The fan motor (MV) is powered by triac TY6 (connector D3 on the circuit board) and by the contacts of the ON/OFF switch (PU) and the door switch (IP).

The drying time is variable and pre-defined for each washing cycle.

In some programmes, the fan remains in operation for about 20 minutes after the end of the cycle; if the door is opened, the fan switches off.

9 Automatic cycle

9.1 Turbidity sensor

Certain models which feature the turbidity sensor may also feature a special "automatic" programme which optimizes the cycle according to the size of the load and the degree of soiling. This sensor is positioned externally to the sump, in direct contact with the water.

A single container houses the NTC sensor (for control of the washing temperature) and the infra-red opto-electronic sensor, which controls the turbidity of the water and therefore the degree of soiling that it contains.

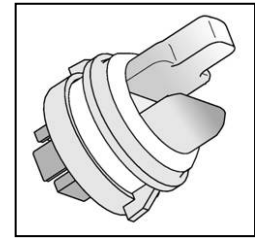

9.1.1 Calculating the degree of soiling

Measurement of the level of turbidity is performed during the cold pre-wash. The photoemitting diode, which is powered by the circuit board (connector G7), transmits a beam of light to the photoreceiver. The circuit of the photoreceiver (connector G8 on the circuit board - G6 is the common contact) is traversed by a certain current whose intensity is proportional to the quantity of light received (i.e. inversely proportional to the level of turbidity).

The microprocessor measures the signal present in the circuit, and can thus determine the most appropriate cycle according to the quantity of soiling present in the water.

9.1.2 Determination of the load

The quantity of dishes in the load (full load or 1/2 load) is determined during the initial heating phase during washing by controlling the rate at which the temperature of the water increases (NTC sensor, connector G5).

- ↪ **Full load:** when the inclination of the curve is below a certain threshold which is memorized as standard.
- ↪ **Half load:** when the inclination of the curve is above the standard threshold.

9.2 Automatic Programme

The table below shows the variations in the programme phases according to the type of soiling and the size of the load.

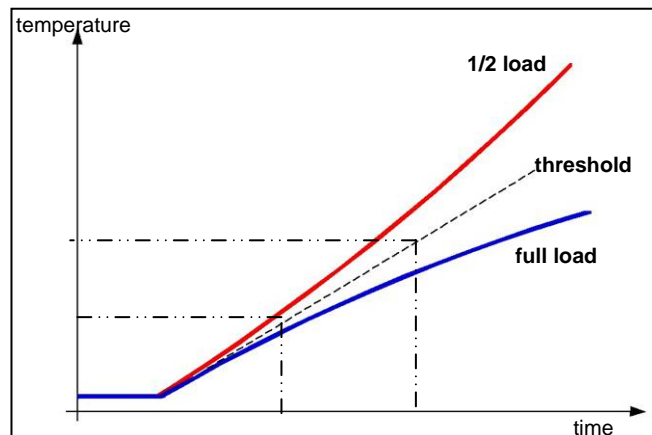

Type		Programme phases					
Load	Heavy soil	Pre-wash	Wash	First rinse	Second rinse	Hot rinse	Drying
Full	Yes	Cold	68° C	Cold	Cold	68° C	24 min.
Full	No		55° C		no		
Half	Yes		55° C				
Half	No		50° C				

10 Alarms

In the event that an abnormal situation should occur which might affect the correct operation of the appliance, the circuit board causes a safety system to intervene. In most cases, this interrupts the washing cycle. The last three alarm conditions are stored in memory.

Using a special procedure available only to Service Engineers, it is possible to read all the alarms stored in memory. However, only four current alarm conditions are displayed to the user. The alarms are displayed by the display and with a series of “beeps” from the buzzer (only certain models).

10.1 Table of alarms

Type of alarm	Display	Displayed to the user	Description of the alarm condition	Machine status	Possible causes
i10	.10	YES	Water fill time-out (The pressure switch does not close on FULL after 90 sec. static fill, or never closes on “FULL” during the initial 60 sec of the dynamic fill at 2800 rpm)	The drain pump switches on, then the cycle stops	Tap closed; water mains pressure too low; fill solenoid / wiring faulty; hydraulic circuit of pressure switch obstructed; level pressure switch / wiring faulty; circuit board faulty (solenoid triac short-circuited)
i20	.20	YES	Water drain time-out (The pressure switch does not return to EMPTY after two drain phases lasting 120 seconds) (**)	The drain pump switches on, then the cycle stops	Drain circuit obstructed/blocked; drain pump interrupted or jammed (foreign bodies); level pressure switch blocked on FULL (1-3); hydraulic circuit of pressure switch obstructed; wiring faulty; circuit board faulty
i30	.30	YES	Intervention of Anti-flooding system (the drain pump switches on)	The cycle is interrupted and the drain pump switches on	Water leakage from the tub - sump and various connections (pump, upper spray arm duct etc.); floating sensor blocked mechanically; microswitch faulty; fill solenoid blocked mechanically; circuit board faulty (solenoid triac short-circuited); wiring faulty
i50	.50	NO	Motor triac short-circuited (the washing pump runs uncontrolled at maximum speed)	Water fill to level (if necessary), disactivation of the other actuators, cycle interrupted. The washing motor runs at maximum speed and the alarm is displayed.	Circuit board faulty
i60	.60	YES	Over heating Temperature higher than 78°C	The cycle is interrupted and the drain pump switches on	Heating element faulty; intervention of safety thermostats (open); wiring faulty; NTC sensor (poor thermal contact); insufficient water circulating in the tub; washing pump faulty (impeller stripped); circuit board faulty.

(**) If inside the appliance there is no water at all (correct drain) but this alarm is displayed, check the heater (possible dispersion) and the anti-interference suppressor.

Type of alarm	Display	Displayed to the user	Description of the alarm condition	Machine status	Possible causes
i60	.60	NO	Heating Time-out (the check takes place every 3 minutes: the temperature must increase by a certain amount at each step)	The programme continues to the end without heating (the washing result will probably be unsatisfactory)	Heating element faulty; intervention of safety thermostats (open); wiring faulty; NTC sensor (poor thermal contact); insufficient water circulating in the tub; washing pump faulty (impeller stripped); circuit board faulty.
i70	.70	NO	NTC sensor short-circuited or open	The programme continues to the end without heating (the washing result will probably be unsatisfactory)	NTC sensor faulty; wiring short-circuited / open; circuit board faulty.
i80	.80	NO	Communication error between the microprocessor and the EEPROM	Machine inoperative: no selection possible (*)	Circuit board faulty.
i90	.90	NO	Problems with software configuration	The fault occurs when switching on: no selection possible (*)	Circuit board faulty (configuration software incorrect).
ib0	.b0	NO	Problems with the turbidity meter [if featured] (Calibration Time-out)	The programme continues as if a "heavy soiling" condition had been detected.	Turbidity sensor faulty; sensor wiring faulty; circuit board faulty.
id0	.d0	NO	Problems with the washing motor: no signal from the tachometric generator (washing pump powered, but no signal from the generator)	The heating element is switched off. If the fault persists after the Time-out, the washing pump operates at maximum speed and the alarm code is stored in memory (the cycle continues)	Motor winding interrupted / short-circuited; motor jammed (foreign bodies); wiring to washing motor faulty; motor capacitor faulty; Tachometric generator interrupted / short-circuited; circuit board faulty.
iF0	.F0	NO	Water replenishment Time-out (3 times during the T.S. Time-out)	The cycle continues until the next phase without supplementary fills and without heating. The error is cancelled on completion of a drain phase.	Dishes upside-down; central filter clogged; excessive foam; leaks from the sump-pressure switch coupling; pressure switch faulty / false contacts.

(*) If it is not possible to access diagnostics mode, switch the appliance off and then on again to check that this is not caused by a temporary fault. Before replacing the circuit board, check that it is correctly powered by controlling the following

- ↻ Continuity of the power cable
- ↻ Correct operation of the suppressor
- ↻ Closure of the door switch contacts
- ↻ Continuity of the wiring between connectors A2/B1 on the circuit board and the suppressor.

11 USER MODE

This procedure can be used to:

- modify regeneration levels
- activate or not rinse aid function
- activate or not the buzzer

11.1 Regeneration levels

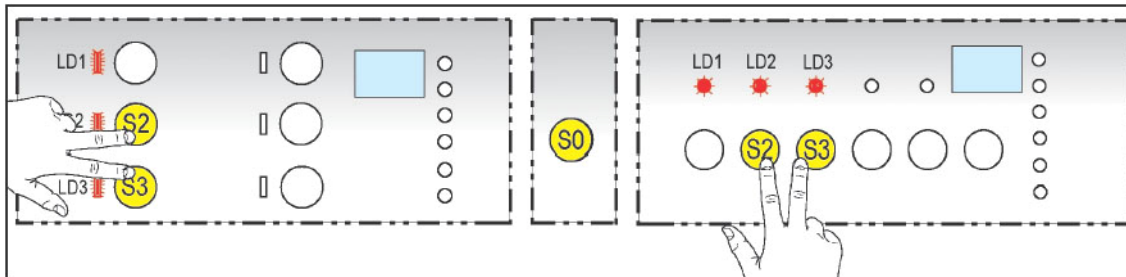

1. Cancel any cycles that may have been selected.
2. Press key **S0** to switch the appliance on.
3. Press buttons **S2-S3** simultaneously, and hold down until LEDs LD1, LD2 and LD3 begin to flash.

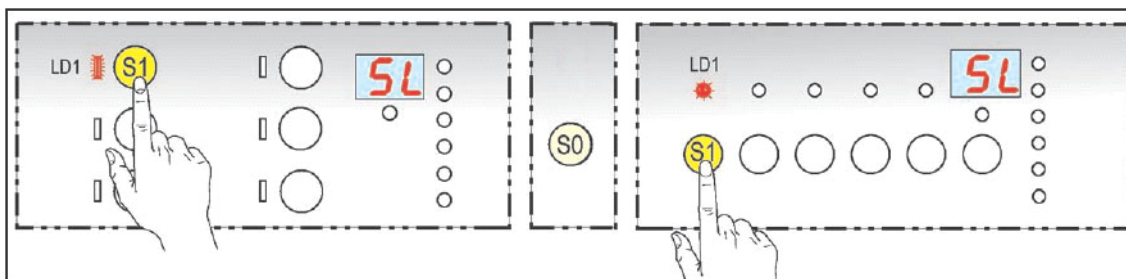

4. Press button **S1**: LEDs LD2, LD3 switch off, while LD1 continues to flash.
 ↻ The regeneration level is shown by the display [**5L**].
5. Press button **S1** sequentially to modify the level of regeneration.
 ↻ Each time the button is pressed, the regeneration level increases by 1 level. If **S1** is pressed after the 10th level has been reached, the setting returns to level 1. [**5L** ↻ **6L** ↻ **7L** ↻ **10L** ↻ **1L** ↻ **2L**.....]
6. To store this setting in memory: press button **S0** and switch the appliance off; alternatively, wait for 60 seconds (selection mode)

Level	Display	Water introduced between regeneration cycles	Aperture of regeneration solenoid	Position of selector in the tub	Hardness of the water	
					° F (TH)	° D (dH)
	n°	litres	sec	n°		
1	1	---	0	1	0 > 7	0 > 4
2	2	130	240	1	8 > 18	4 > 10
3	3	94	240	1	19 > 25	11 > 14
4	4	70	240	1	26 > 32	15 > 18
* 5	5	53	240	2	33 > 39	19 > 22
6	6	37	240	2	40 > 50	23 > 28
7	7	20	240	2	51 > 64	29 > 36
8	8	15	240	2	65 > 75	37 > 42
9	9	10	240	2	76 > 90	43 > 50
10	10	3	2x240	2	91 > 125	51 > 70

* "5" = factory-set level Position of selector in tub: "2"

11.2 Rinse aid function

This function is active all the time. Only in case of "3in1" option setted up this function is not activated. If the drying results are not good, with "3in1" option setted up, is it possible to activate rinse aid function using the procedure described below.

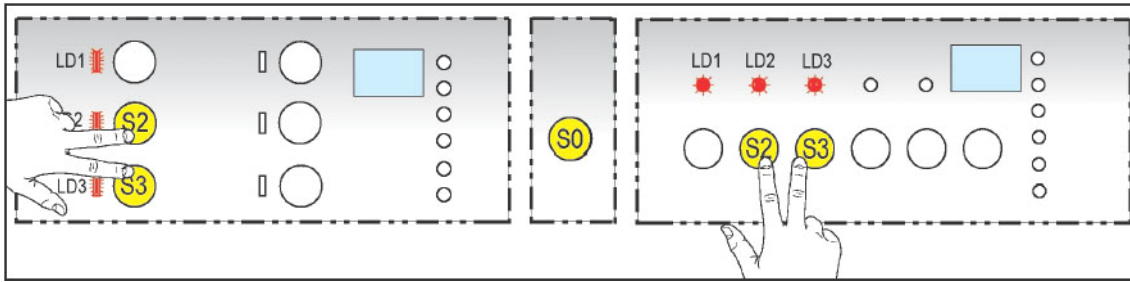

1. Cancel any cycles that may have been selected.
2. Press **S0** to switch the appliance on.
3. Press buttons **S2-S3** simultaneously, and hold down until LEDs LD1, LD2 and LD3 begin to flash.

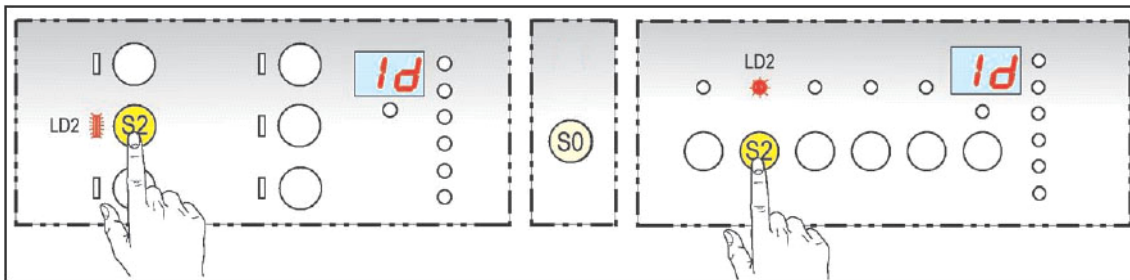

4. Press button **S2**: LEDs LD1 and LD3 switch off, while LD2 continues to flash.
 ↪ The condition of the function is indicated by the display: **1d** rinse-aid function is operative, **0d** rinse-aid function is inoperative
5. Press button **S2** again to deactivate/activate the rinse-aid function.
6. To store this setting in memory: press button **S0** and switch the appliance off; alternatively, wait for 60 seconds (appliance in selection mode)

11.3 Activating/deactivating the buzzer

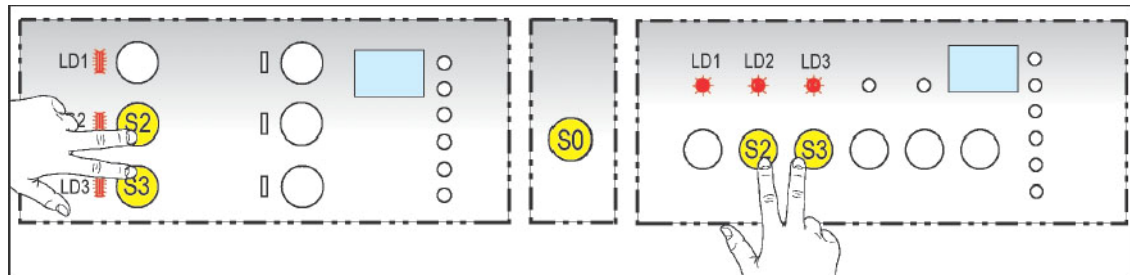

1. Cancel any cycles that have been selected.
2. Press **S0** to switch the appliance on.
3. Press buttons **S2** and **S3** at the same time until LEDs LD1, LD2 and LD3 begin to flash.

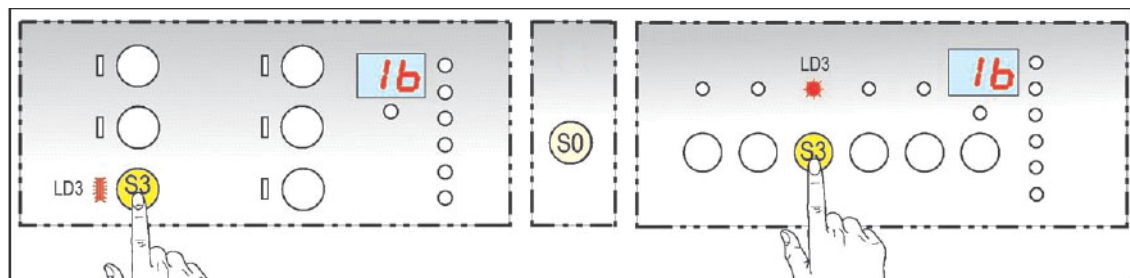

4. Press button **S3**: LEDs LD1 and LD2 switch off, while LD3 continues to flash.
 ↪ The condition of the buzzer is indicated by the display: **1b** buzzer on, : **0b** buzzer off
5. Press button **S3** again to deactivate/activate the buzzer
6. To store this operation in memory: press button **S0** and switch the appliance off or wait 60 seconds, the appliance is in selection mode.

12 Diagnostics mode / Options

A single procedure can be used by Service Engineers to access the diagnostics system. After accessing diagnostics mode, the Engineer can:

- read / cancel the alarms,
- check for correct operation of the various components of the appliance,
- start the diagnostics cycle and select the options available to Service Engineers.

12.1 Accessing diagnostics mode

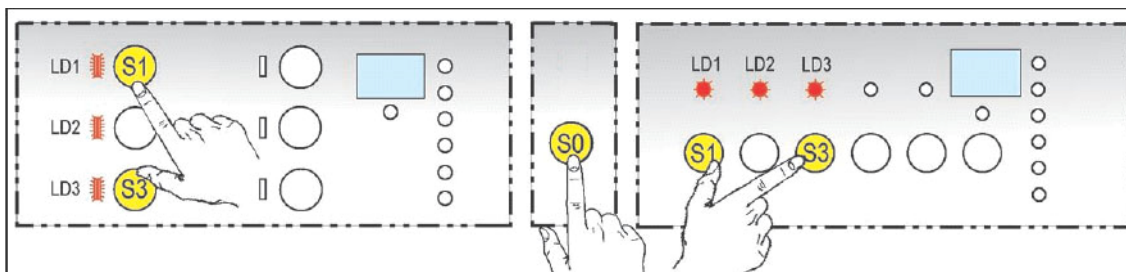

1. Switch off the appliance.
2. Press buttons **S1-S3** simultaneously and hold down.
3. Press key **S0** to switch the appliance on, still holding down buttons S1 - S3 until LEDs LD1, LD2 and LD3 begin to flash.

12.2 Reading the alarms and activating the individual components

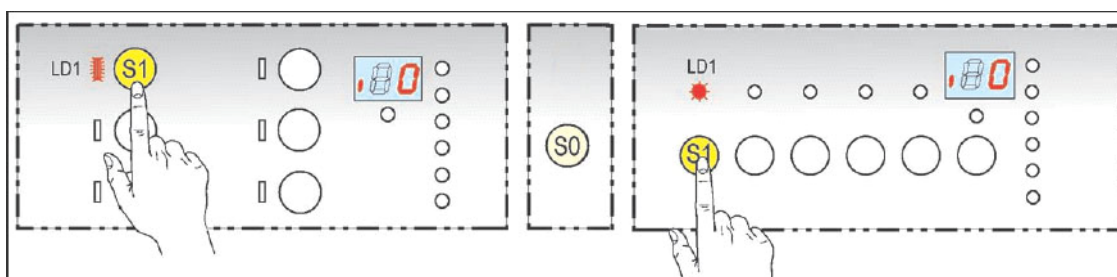

1. Access diagnostics mode
2. Press button **S1** to start the function.
 - ↪ LEDs LD2 and LD3 switch off; LD1 continues to flash.
 - ↪ The first alarm stored in memory is displayed [**ix0**] (for the codification see the summary table of the alarms – pages 27, 28).
3. Press **S1** to display the other two alarms and to activate the electrical components.
 - ↪ The display shows, after the first three alarms, the number corresponding to the activated function.
4. All the positions can be repeated by pressing sequentially S1.

Activation S1	Display	Activated function
1	ix0	⇒ Reading of the last alarm occurred
2	ix0	⇒ Reading of the last alarm but one occurred
3	ix0	⇒ Reading of the last alarm but two occurred
4	4	⇒ Activation of the solenoid regeneration
5	5	⇒ Activation of drain pump
6	6	⇒ Water fill solenoid to level
7	7	⇒ Heating (<i>only if water level is OK!</i>)
8	8	⇒ Washing pump at 2800 g/
9	9	⇒ Detergent/rinse-aid dispenser
10	10	⇒ Drying fan (<i>if turbo-dry</i>)
	The components are powered when the door is closed: open the door to select a different component, then re-close the door. If button S1 is not pressed for 60 seconds, the system automatically exits diagnostics mode).	

12.3 Cancelling alarm codes from memory / Testing the LEDs

It is good practise to cancel the alarm codes after reading the alarm code or after effecting repairs to check whether it is repeated during the diagnostics test.

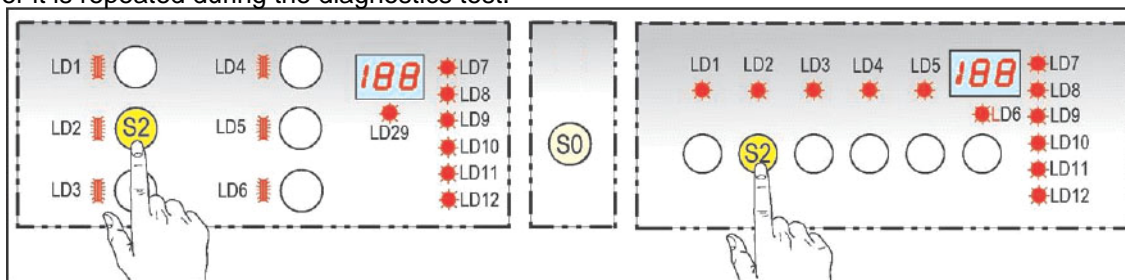

1. Access diagnostics mode
 2. Press button **S2** to cancel the alarms.
- ↪ All the LEDs and the digits [188] flash for about 30 seconds.
 - ↪ The function terminates automatically and the machine enters pre-selection mode.

12.4 Functional testing cycle

This is an abbreviated washing programme which allows the Service Engineer to test all the functions that comprise a traditional washing cycle; in effect, the system simulates a normal cycle.

12.4.1 Selecting the cycle

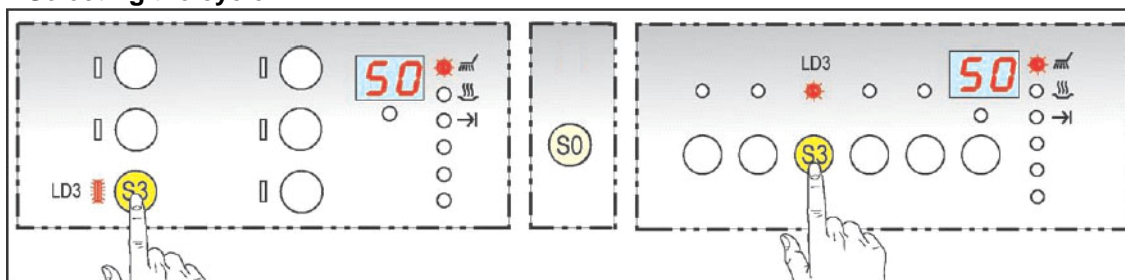

1. Access diagnostics mode
 2. Press button **S3** to start the cycle.
- ↪ The LEDs LD1, LD2 switch off while LD3 continues to flash while the LED of the current phase is steady.
 - ↪ The display shows the time-to-end.
 - ↪ The programme behaves as in a normal cycle; the PAUSE and CANCEL options are accessible.

12.4.2 Cycle phases

Phase	Time
Drain till level	
Filling of water	30s
Filling of water till level	
Filling	5s
Drain till level	
Drain	15s
Check of pressure switch; washing motor at 2800rpm	5s
Check of pressure switch; washing motor at 2800rpm	20s
Washing motor at 2800rpm; heating element till 50°	max 20minutes
Opening of the dispenser; check of pressure switch; washing motor at 2800rpm	45s
Drain till level	
Drain	30s
Opening of regeneration valve; activation of turbo	90s
Drain till level	
Drain	20s

N.B.:

- The overall duration of the test cycle is about 50 minutes.
- At the beginning of the subsequent programme (i.e. after the test cycle), the resins are washed.

12.5 Options available to Service Engineers

In particular circumstances, i.e. if the user reports unsatisfactory washing results, a special procedure, available only to Service Engineers, can be used to select two supplementary options designed to improve performance:

- Extra cold rinse.
- Disabling of pulse washing (**PW**), replaced by continuous washing (**Ctrl**).

12.5.1 Selecting the extra cold rinse option

Using the procedure described below, it is possible to add a supplementary cold rinse in all the washing programmes. This improves the quality of the rinse in case of necessity.

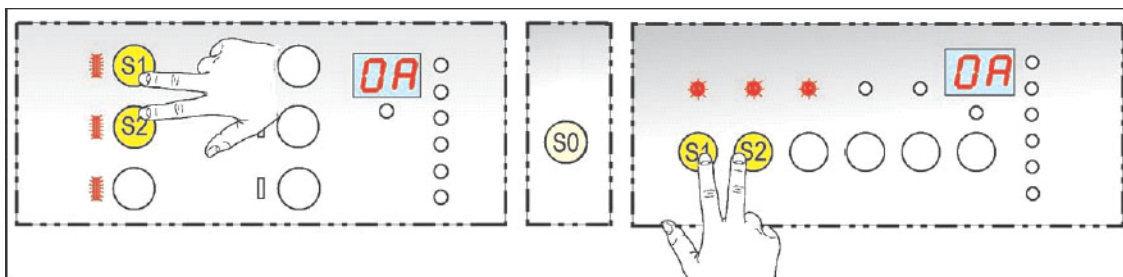

1. Access diagnostics mode
2. Press buttons **S1-S2** simultaneously.
- ↳ The display indicates the status of the function: [**0A**] extra rinse not selected, [**1A**] extra rinse active.

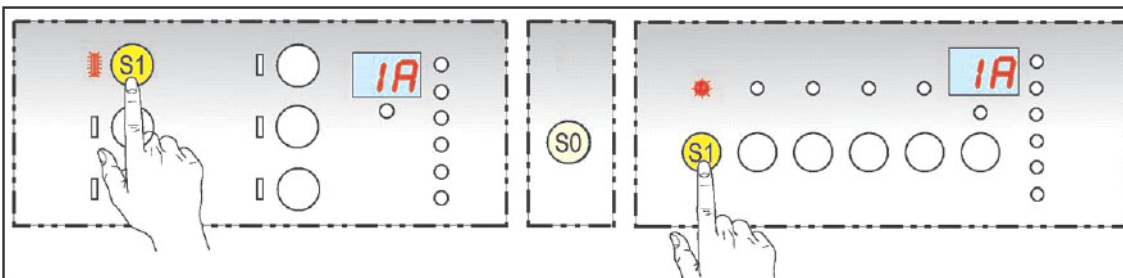

3. Press button **S1** to activate and deactivate this function.
- ↳ [**0A**] extra rinse not selected, [**1A**] extra rinse selected.
4. To store the operation in memory: press key **S0** and switch the appliance off; alternatively, wait for 60 seconds (appliance in selection mode).

12.5.2 Disabling pulse washing

Certain programmes use the pulse washing system (**PW**). Using the procedure described below, the Service Engineer can modify this system so that **Ctrl** (continuous) washing is used in all those programmes which normally use the **PW** system. This intensifies the washing action even in delicate programmes.

Deactivation/activation mode

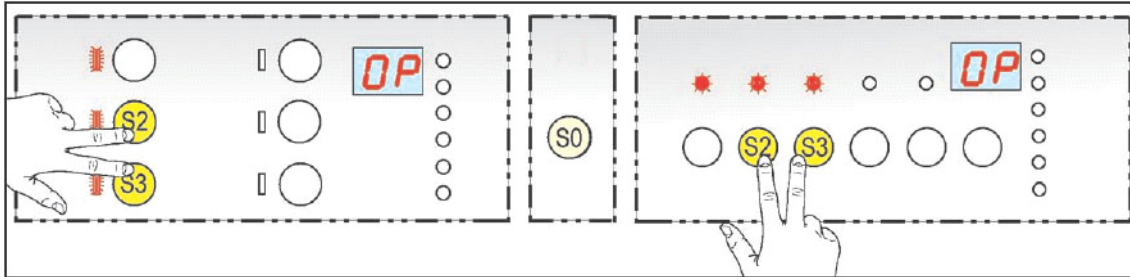

1. Access diagnostics mode
2. Press buttons **S2-S3** simultaneously. The display indicates the status of the function:
↵ [**OP**] continuous washing "**Ctrl**"; [**1P**] pulse washing "**PW**" active.

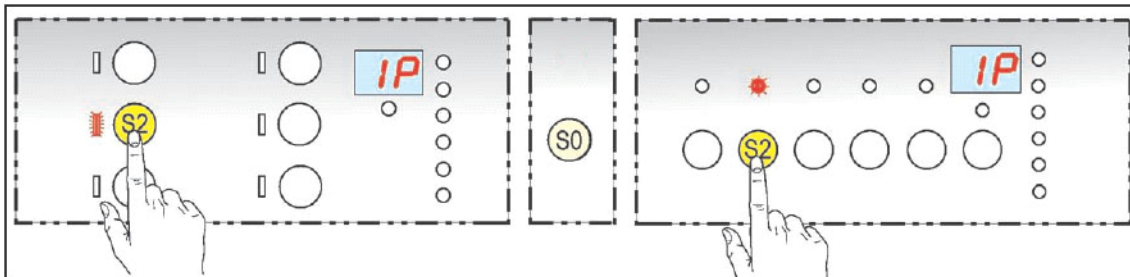

3. Press button **S2** to activate and deactivate this function:
↵ [**OP**] continuous washing "**Ctrl**"; [**1P**] pulse washing "**PW**" active.
4. To store the operation in memory: press key **S0** and switch the appliance off or wait for 60 seconds (appliance in selection mode)

12.6 Exiting diagnostics mode

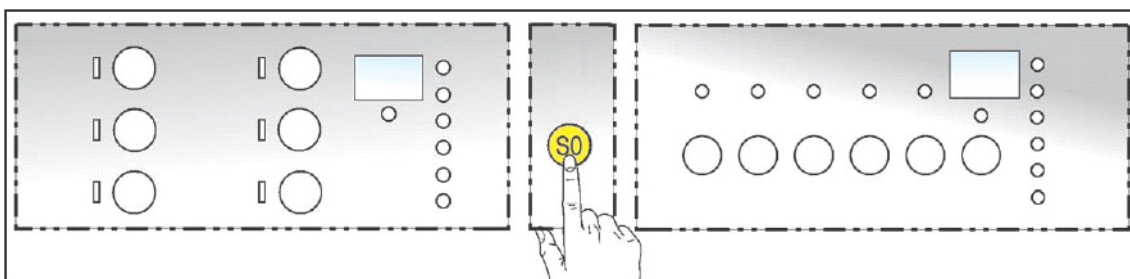

1. To exit the diagnostics cycle, press key **S0** and switch the appliance off.
- or:
2. wait **60 seconds**: the appliance returns to programme selection mode.

13 ELECTRICAL FUNCTIONS

13.1 Electrical circuit diagram

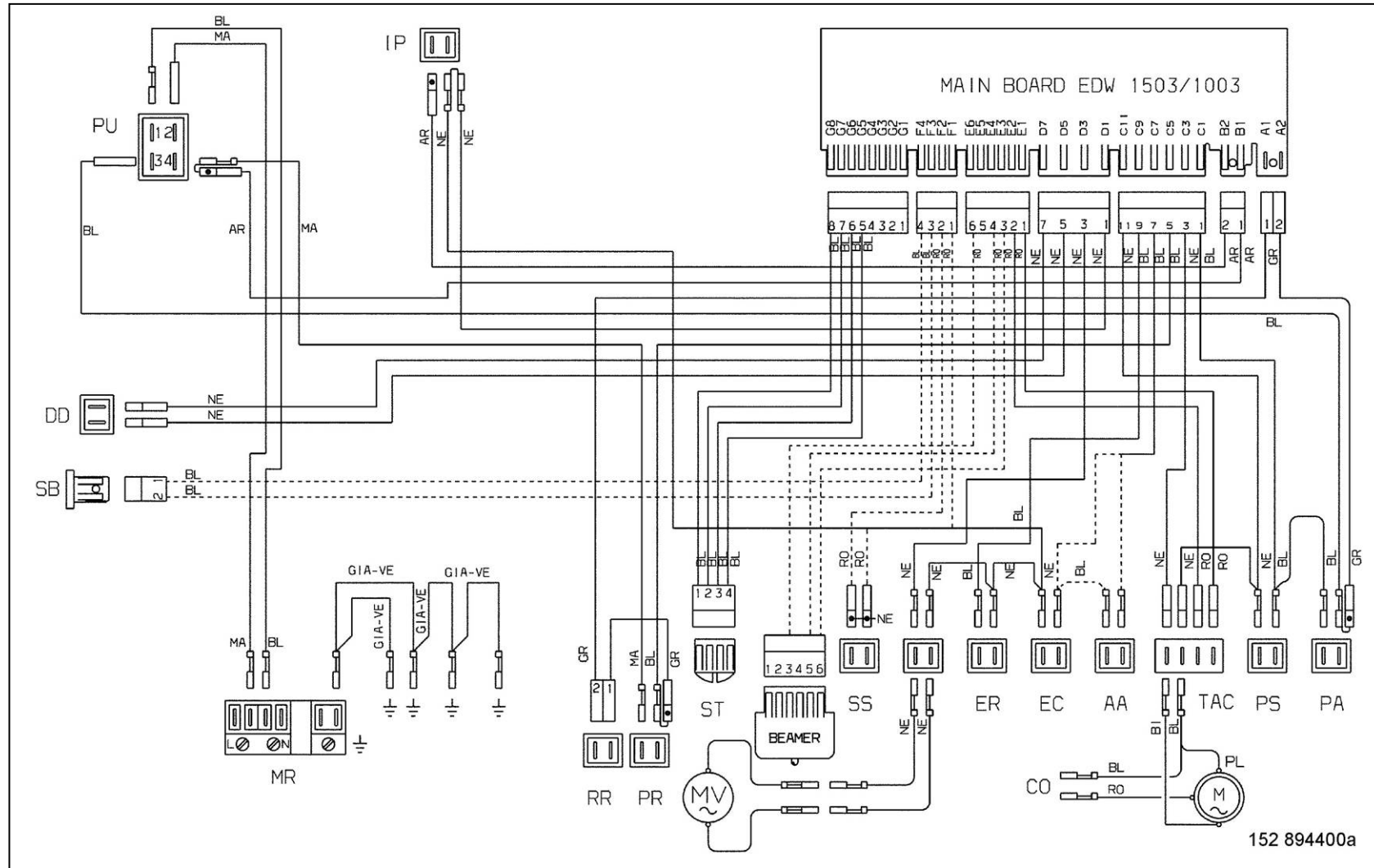

13.2 Basic circuit diagram

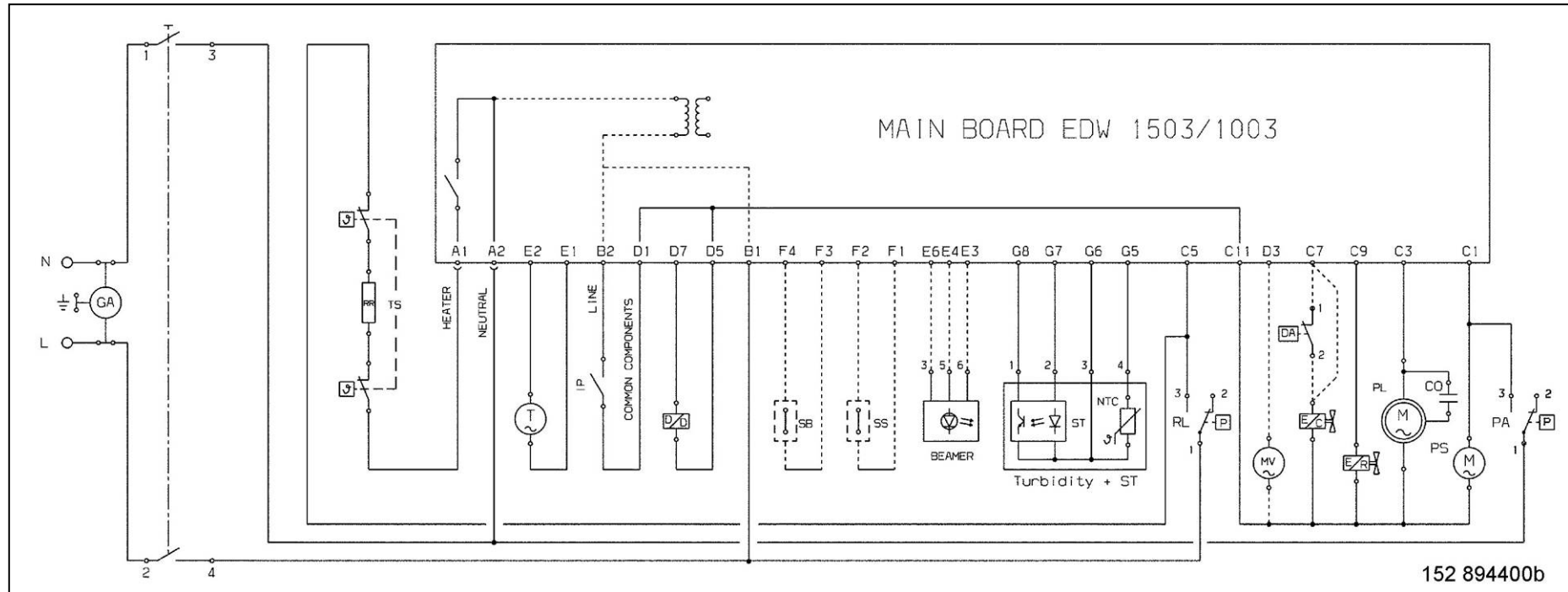

13.2.1 Key to circuit diagram

AR = Orange	NE = Black	CO = Capacitor	MR = General terminal block	PA = Anti-overflow pressure switch	TAC/T = Tachometric generator
BI = White	RO = Pink	DD = Detergent/ Rinse-aid dispenser	MV = Fan motor	RR = Heating element	TS = Safety thermostat
BL = Blue	VI = Lilac	EC = Fill solenoid	PL = Washing pump	SS = Salt sensor	Main Board = Main board
CE = Light blue	AA/DA = Anti-flooding device	ER = Regeneration solenoid	PS = Drain pump	Turbidity = Turbidity sensor	User Interface = Display board
GI-VE = Yellow-Green	Beamer = Beamer	GA = Suppressor	PU = Pushbutton array	ST = Temperature sensor	
MA = Brown		IP = Door switch	PR/RL = Level pressure switch		

14 Table of programmes

The table below lists the phases of the programmes for this type of appliance. As these can be configured differently, refer to the relative documentation for the specific cycles available for each model.

Programmes		Pre-wash			Wash					Cold Rinse			Hot rinse			
Type	Programme	Heating (Temperature in °C)	Wash time after heating (min.)	Type of Wash	1 st Heating (Temperature in °C)	Wash time after heating (min.)	2 nd Heating (Temperature in °C)	Wash time after heating (min.)	Type of Wash	Wash time (minutes)	Wash time (minutes)	Type of Wash	Heating (Temperature in °C)	Wash time after heating (min.)	Type of Wash	Cycle time (minutes)
I3	Intensive short	50°C	2,5'	ctrl	50°C	10'	68°C	---	ctrl	2x5' (<68°C)	5'	ctrl	69°C	---	ctrl	88'
N5	Normal 3 rinses	---	6'	ctrl	50°C	4'	68°C	8	ctrl	2x3' (<65°C)	3'	ctrl	69°C	---	ctrl	102'
E1	Energy label	---	10'	pw1	15.5' <62°C	42'	---	---	pw1	5' (<60°C)	---	pw1	16' <68°C	2'	pw1	162'
Q4	Rinse and hold	---	8'	pw1	---	---	---	---	---	---	---	---	---	---	---	12'
Q5	Short 30 min.	---	---	---	14,5' <65°C	---	---	---	ctrl	---	---	---	9' <68°C	---	ctrl	31'

N.B.: The overall times for the programmes (duration) are approximate, and do not take into consideration the extra rinse, which may be selected as an option. The various phases do not include the times for regeneration/washing of the resins which, being performed "Ad Hoc", are not carried out at every cycle.

ctrl ⇒ Continuous washing at 2800 rpm. **PW** ⇒ Pulse washing at 1600 > 2800 rpm.

15 Checking the efficiency of the components

In order to facilitate the control procedure for the components to be tested, a TEST PROCEDURE has been created which indicates the point to which the probes of the tester should be applied and the correct theoretical value for each component tested.

- ↔ Remove the door and detach all the connectors from the main board.
- ↔ Connect the probes of the tester to the appropriate points on the connector. Compare the ohmic reading with the theoretical value.

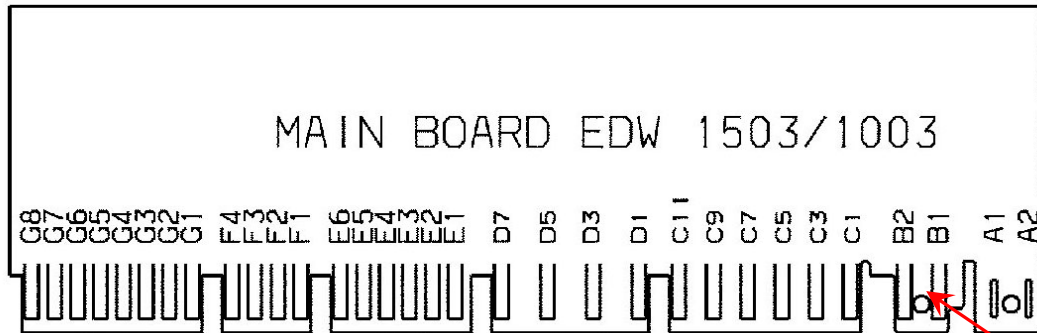

Care should be taken relative to the position of connector "B1" - "B2": if this connector is replaced in the incorrect position (back-to-front), the appliance will not function. The board will not accept any commands since the power supply will be disconnected.

15.1 Measurement points on the board wiring connector

LIST OF COMPONENTS	PROBE CONTACTS	CORRECT VALUES	NOTES
* POWER CABLE & (PU) - ON/OFF SWITCH	L ↔ B1	⇒ 0 Ω	with ON/OFF key pressed
	N ↔ A2	⇒ 0 Ω	
(RR) - HEATING ELEMENT + (TS) - SAFETY THERMOSTAT	A1 ↔ C5	⇒ 25 Ω ± 8%	connected in series (2100W)
(PR) - LEVEL PRESSURE SWITCH	B1 ↔ C5	⇒ INFINITE	on "EMPTY" (1-2)
		0 Ω	on "FULL" (1-3)
(PA) - ANTI-FLOODING PRESSURE SWITCH	C1 ↔ A2	⇒ INFINITE	on "EMPTY" (1-2)
		0 Ω	on "FULL" (1-3)
(IP) - DOOR MICROSWITCH	B2 ↔ D1	⇒ 0 Ω	Door closed
(DD/DB) - INTEGRATED DISPENSER	D5 ↔ D7	⇒ 1.500 Ω ± 8%	OK
(SB) - RINSE-AID SENSOR	F3 ↔ F4	⇒ INFINITE	with Rinse-aid
		0 Ω	without Rinse-aid
(SS) - SALT SENSOR	F1 ↔ F2	⇒ INFINITE	with salt
		0 Ω	without salt
(ST) - TEMPERATURE SENSOR	G5 ↔ G6	⇒ 4850 Ω ± 5%	(at 25°C)
		1205 Ω ± 5%	(at 60°C)
(GT) - TACHYMERIC SENSOR	E1 ↔ E2	⇒ 210 Ω ± 8%	OK
(MV) - FAN MOTOR	D1 ↔ D3	⇒ 7750 Ω ± 8%	OK
(ER) - REGENERATION SOLENOID	D1 ↔ C9	⇒ 6 KΩ ± 8%	OK
(EC) - FILL SOLENOID + (AA) - ANTI-FLOODING DEVICE	D1 ↔ C7	⇒ 3.800 Ω ± 8%	connected in series
(PL) - WASH MOTOR	D1 ↔ C3	⇒ 50 Ω ± 8%	start-up winding
	To the two motor wires (blue) / (red)	⇒ 180 Ω ± 8%	auxiliary winding
(PS) - DRAIN MOTOR	D1 ↔ C1	⇒ 180 Ω ± 8%	OK

Note: - *) = Measurement points L and N refer to the pins of the plug fitted to the power cable.

16 QUICK GUIDE TO THE SPECIAL FUNCTIONS

The table below briefly describes how each of the special functions available to the user and to the Service Engineer can be used.

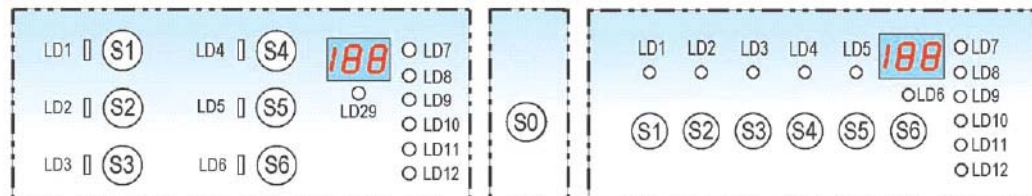

	Function		Activation of the function		Starting the function		Brief description / Comments
	↓		Keys	Led(s)	Keys	Led(s)	
USER (*)	Select regeneration	S0 (On/Off) ↓ [S2 + S3]	→	LD1 + LD2+ LD3 flashing	→	S1 → 1L 10L	→ Press S1 : Lev....[1L].....[2L]....[3L].....[4L].....[5L].... [6L].....[7L].... [8L].....[9L].....[10L] °F... >8 >14>20 >30 >40 >50 >60 >70 >80 >90 °D... >4 >8 >11 >17 >22 >28 >33 >39 >45 >50
	Deactivate rinse-aid	S0 (On/Off) ↓ [S2 + S3]	→	LD1 + LD2+ LD3 flashing	→	S2 → 0d / 1d	→ Press S2 and press again: 1d = rinse-aid activated, 0d = not activated only with 3in1 option
	Deactivate buzzer	S0 (On/Off) ↓ [S2 + S3]	→	LD1 + LD2+ LD3 flashing	→	S3 → 0b / 1b	→ Press S3 and press again: 1b = buzzer activated, 0b = not activated
SERVICE ENGINEERS	Display of alarms and components diagnostics	[S1 + S3] ↓ S0 (On/Off)	→	LD1 + LD2 + LD3 flashing	→	S1 → i.0 / 4.....10	→ Press button S1 : [i.0] [i.0] [i.0] [4] [5] [6] [7] [8] [9] [10] AL 1 AL2 ER PS EV RR PL DD MV
	Cancel alarms stored in memory	[S1 + S3] ↓ S0 (On/Off)	→	LD1 + LD2 + LD3 flashing	→	S2 → [188]	→ All the LEDs and digits flash for 30 sec.
	Test cycle	[S1 + S3] ↓ S0 (On/Off)	→	LD1 + LD2 + LD3 flashing	→	S3 → [50] <i>Time to end</i>	→ The cycle starts automatically
	Extra rinse	[S1 + S3] ↓ S0 (On/Off)	→	LD1 + LD2 + LD3 flashing	→	[S1 + S2] ↓ S1 → 0A / 1A	→ Press S1 and press again: 1A = rinse activated 0A = not activated
	Disable pulse washing	[S1 + S3] ↓ S0 (On/Off)	→	LD1 + LD2 + LD3 flashing	→	[S2 + S3] ↓ S2 → 0P / 1P	→ Press S2 and press again: 1P = pulse wash PW activated; 0P = continuous wash
Exit / Memorize	In order to memorize the functions or exit diagnostics mode, press key S0 to switch the appliance off. In most cases, memorization / exit take place automatically after 60 seconds (in which case the appliance returns to pre-selection mode)						

(*) To activate the functions available to the user, no cycles must be selected (i.e. the appliance must be in pre-selection mode).