

# EWM 2100

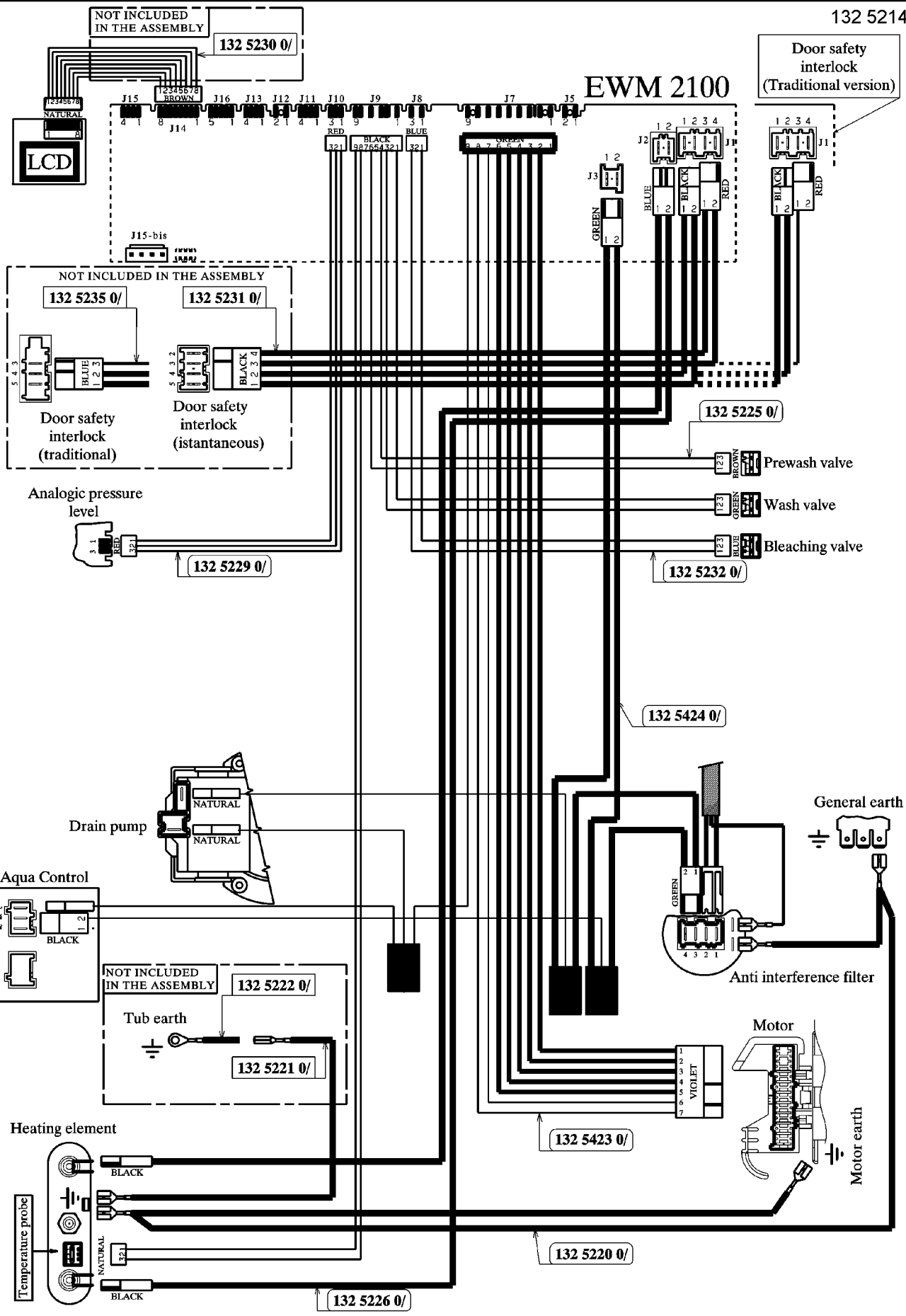

NOT INCLUDED IN THE ASSEMBLY

132 5230 0/



J15-bis

NOT INCLUDED IN THE ASSEMBLY

132 5235 0/

132 5231 0/

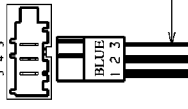

Door safety interlock (traditional)

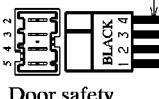

Door safety interlock (instantaneous)

Analogic pressure level



132 5229 0/

132 5225 0/

Prewash valve

Wash valve

Bleaching valve

132 5232 0/

132 5424 0/

Drain pump

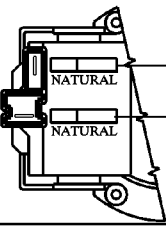

Aqua Control

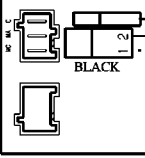

NOT INCLUDED IN THE ASSEMBLY

132 5222 0/

Tub earth

132 5221 0/

Heating element

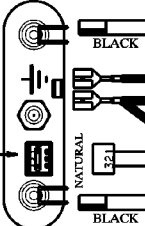

Temperature probe

132 5226 0/

132 5423 0/

132 5220 0/

General earth



Anti interference filter

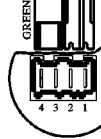

Motor

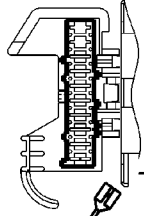

Motor earth