

PRESTOSTATO
PRESSURE SWITCH

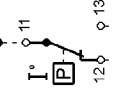

LAMPARA PILOTO
PILOT LAMP

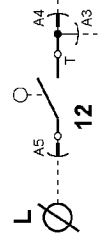

INTERRUPTOR PUERTA
DOOR SAFETY INTERLOCK

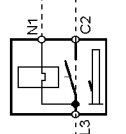

ELECTROVALVULA
COLD WATER INLET VALVE

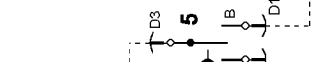

CONDENSADOR
CAPACITOR

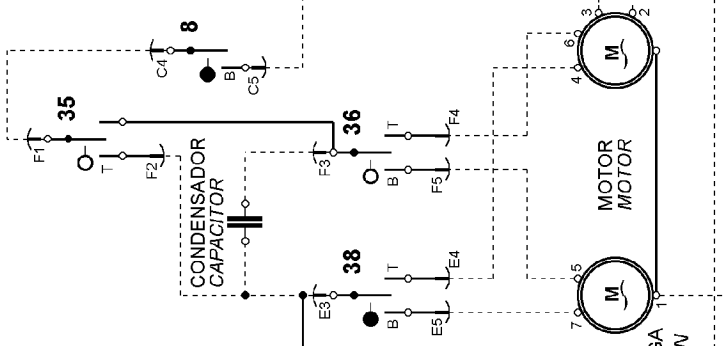
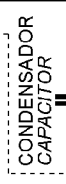

TECLA MEDIA CARGA
HALF LOAD BUTTON



BOMBA DESCARGA
DRAIN PUMP



MOTOR
MOTOR



MOTOR
MOTOR



MOTOR PROGRAMADOR
TIMER MOTOR

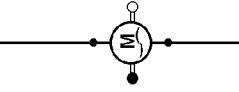

TERMOSTATO
THERMOSTAT

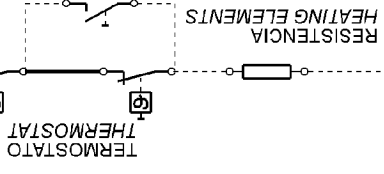

TECLA LAVADO FRIO
COLD WASH BUTTON

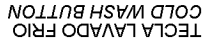

TECLA 90°C
90°C BUTTON

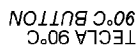

RESISTENCIA
HEATING ELEMENTS



PRESTOSTATO
PRESSURE SWITCH

