

# EWM 2100

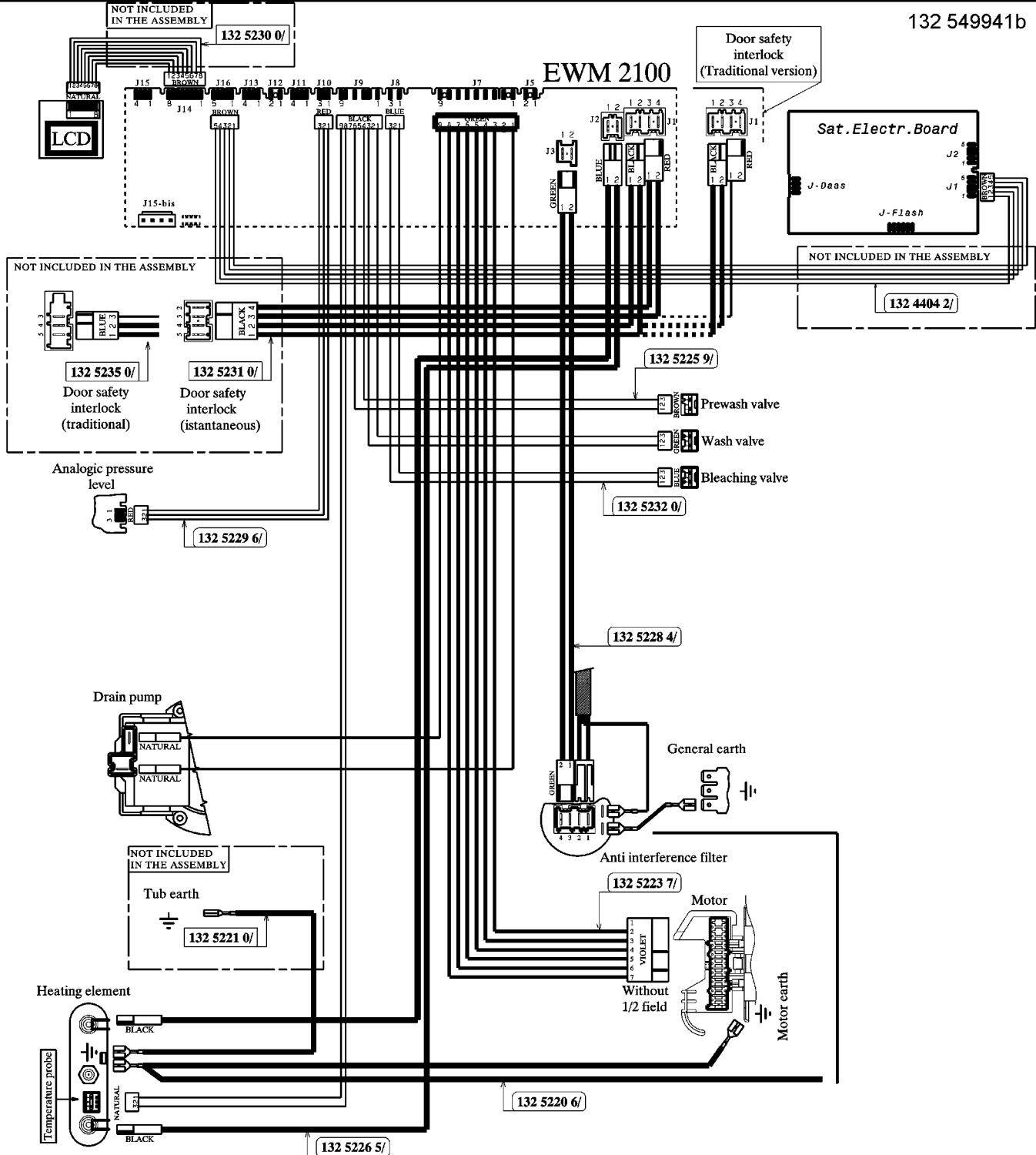

NOT INCLUDED IN THE ASSEMBLY

132 5230 0/

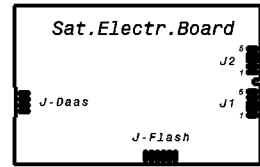

NOT INCLUDED IN THE ASSEMBLY

132 4404 2/

NOT INCLUDED IN THE ASSEMBLY

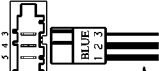

132 5235 0/

Door safety interlock (traditional)

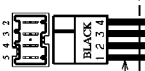

132 5231 0/

Door safety interlock (instantaneous)

Analogic pressure level



132 5229 6/

132 5225 9/

Prewash valve

Wash valve

Bleaching valve

132 5232 0/

132 5228 4/

Drain pump

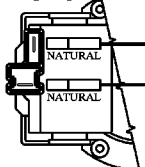

General earth



NOT INCLUDED IN THE ASSEMBLY

Tub earth



132 5221 0/

Anti interference filter

132 5223 7/

Without 1/2 field



Motor

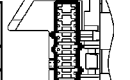

Motor earth

Heating element

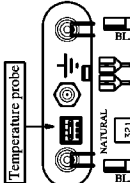

132 5220 6/

132 5226 5/