

Tub earth

132.24000/

Door safety interlock

5432

Heating elements

Temperature probe

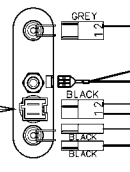

Recirculation pump

Aqua Control

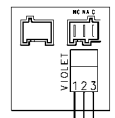

Drain pump

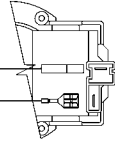

EXTERNAL MOTOR CONTROL BOARD

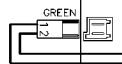

Motor

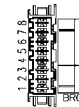

Pressure switch

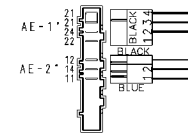

Analogic pressure level



Anti-interference filter



Earth

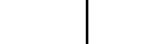

124.11050/

124.96302/

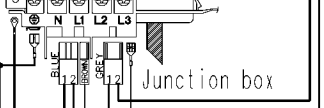

Prewash valve
Wash valve

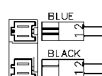

Flow sensor



132.24021/

132.24121/

132.24410/

132.12809/

132.24031/

132.12801/

132.24425/

132.24082/

132.12817/

132.12820/

132.12630/

132.12805/

132.12804/

MAIN ELECTRONIC BOARD

EWM3000 -WM-

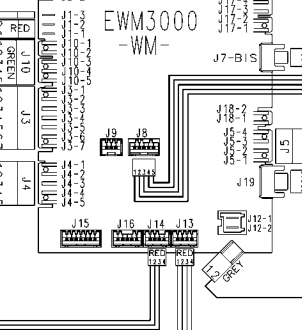

Laundry Centre Board

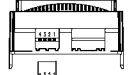

USER INTERFACE BOARD

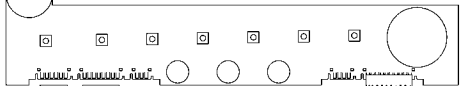

Programme selector

