

Heating elements

Recirculation pump

Door safety interlock

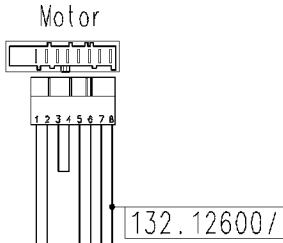
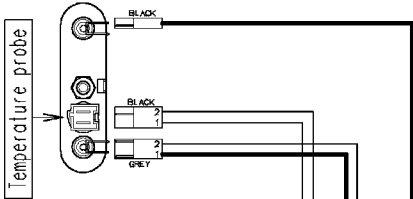

132.12840/

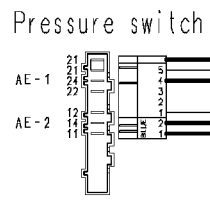
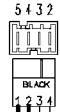
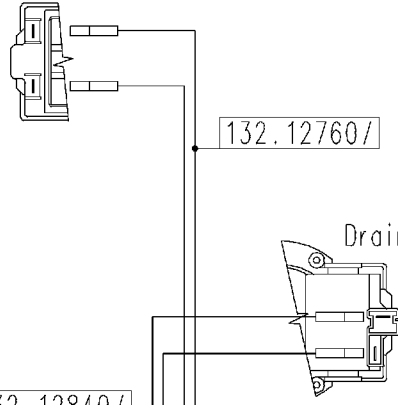

MAIN ELECTRONIC BOARD

EWM2000 EVO WM

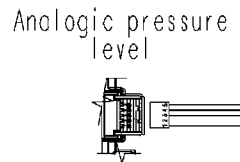

132.12650/

Anti-interference filter 132.12732/

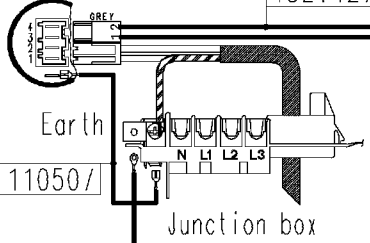

124.11050/

124.34040/

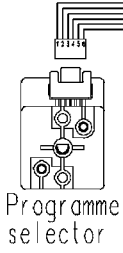

USER INTERFACE BOARD

124.93313/

124.93311/

Motor earth Heating element earth

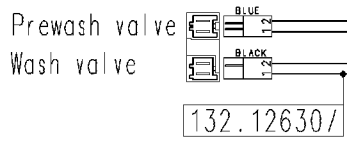

ON/OFF button

37928556/



Pilot lamp