

Heating elements

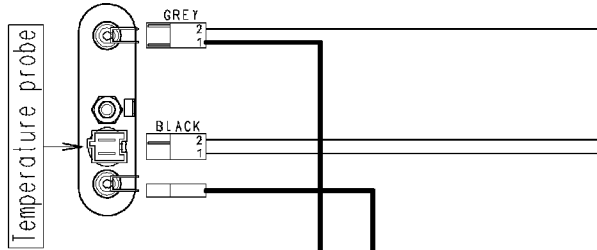

Door safety interlock

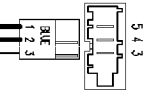

Motor

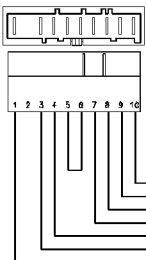

Drain pump

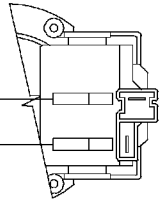

132. 12300/

132. 12360/

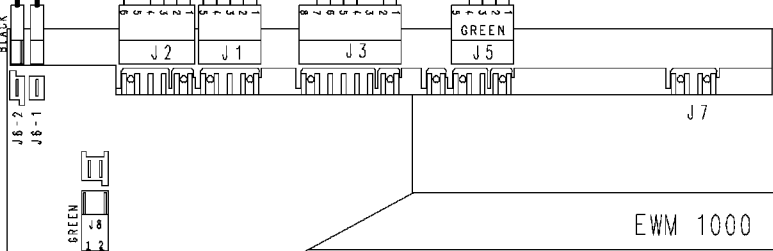

Pressure switch

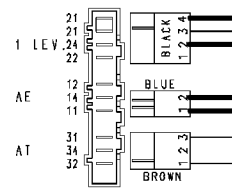

132. 12330/

132. 12310/

132. 12320/

Anti-interference filter

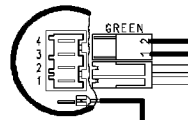

Prewash valve

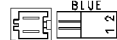

Wash valve



132. 24800/

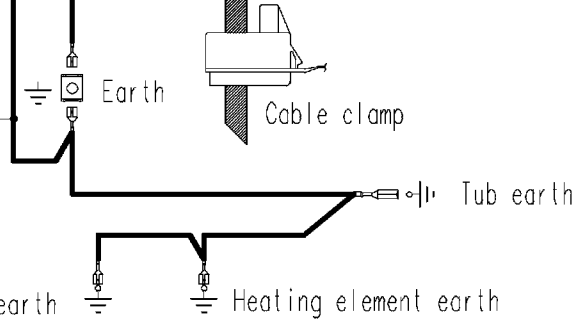

Motor earth

Heating element earth