

Door safety interlock

Heating elements

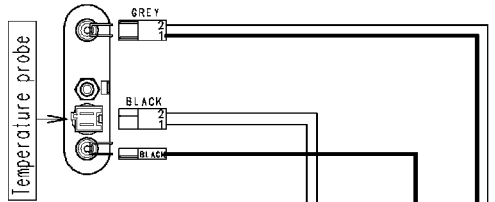

Door locked lamp

37928592/

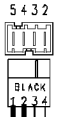

Motor

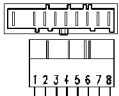

Drain pump

132.12672/

MAIN ELECTRONIC BOARD

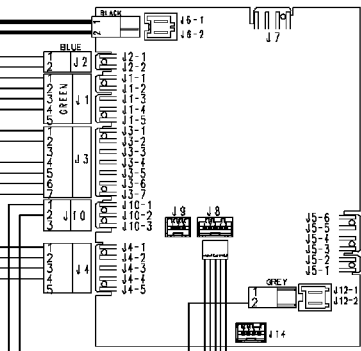

132.12600/

Pressure switch

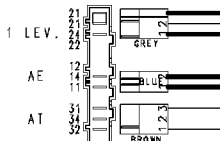

132.12620/

Anti-interference filter

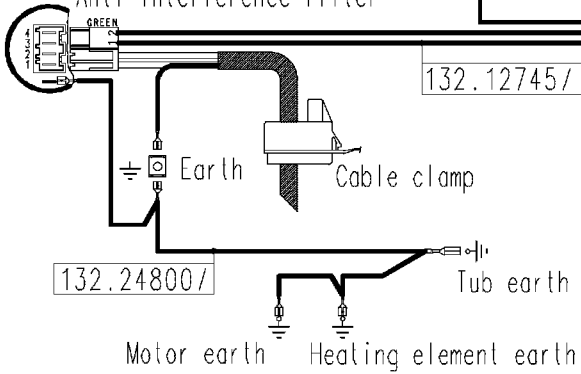

132.12745/

132.24800/

USER INTERFACE BOARD

Programme selector

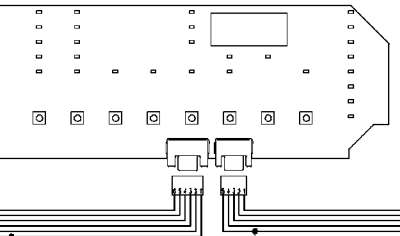
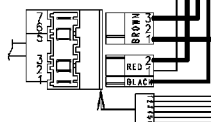

132.12808/

124.93311/

132.12630/

Prewash valve  
Wash valve

