

124 915830b

Heating elements

Door safety interlock

Recirculation pump

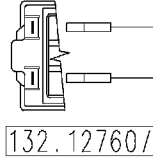

Drain pump

132.24340/

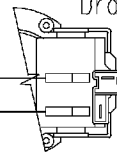

37928593/

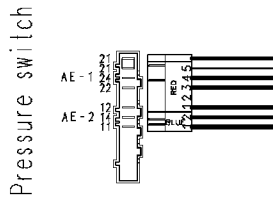
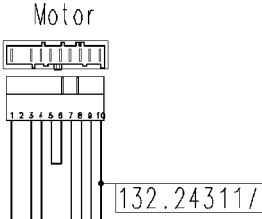
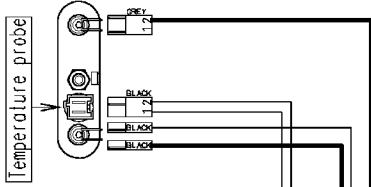

MAIN ELECTRONIC BOARD

EWM2000EVO -WD-

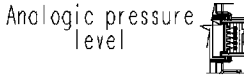
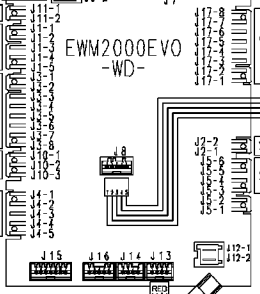

132.12803/

Heating elements (drying)

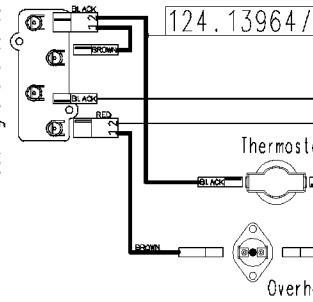

124.13964/

132.24391/

Temperature probe (drying)

132.24380/

Anti-interference filter

132.24403/

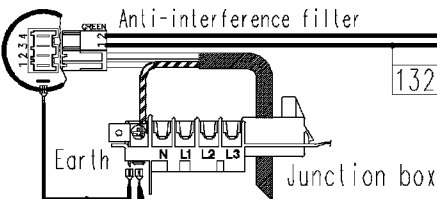

124.11050/

Drying pipe earth

Controls support earth

Tub earth

132.02150/

124.96290/

Motor earth Heating element earth

132.24320/

Wash valve Prewash valve Condensation valve



Temperature probe (drying)

132.24380/

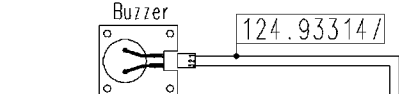

124.93314/

USER INTERFACE BOARD

Programme selector

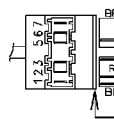

124.93313/

124.93311/