

Door safety interlock

Heating elements

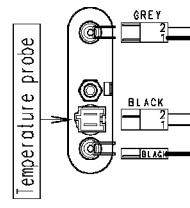

Door locked lamp

37928592/

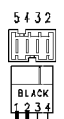

Motor

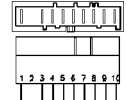

Drain pump

132.12671/

MAIN ELECTRONIC BOARD

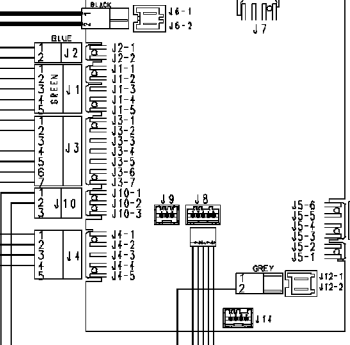

132.12610/

Pressure switch

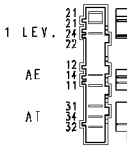

132.12620/

Anti-interference filter

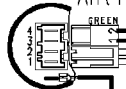

132.12742/

Earth

124.11050/

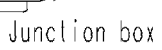

Junction box

124.96300/

124.96290/

Tub earth

Motor earth

Heating element earth

132.12630/

Prewash valve

Wash valve



Programme selector

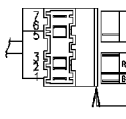

USER INTERFACE BOARD

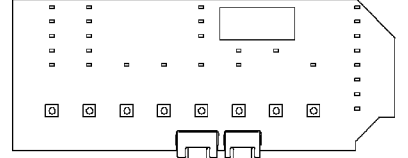

124.93313/

124.93311/