

Motor

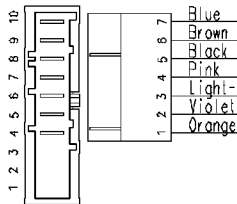

124.34260/

Door safety interlock

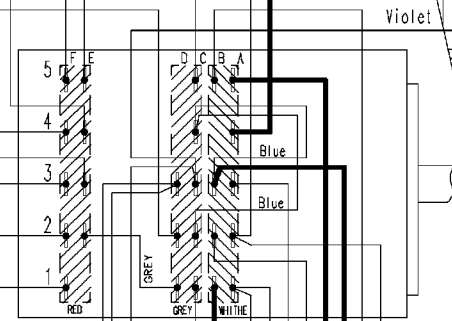
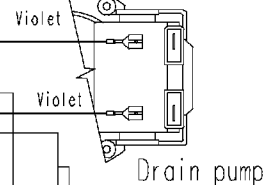
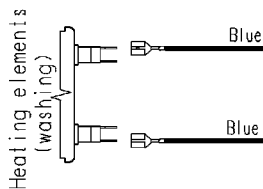
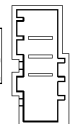

Pressure switch

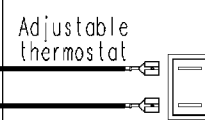
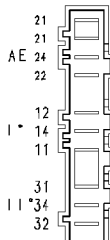

Rinse-hold button

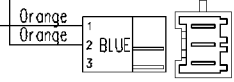

Capacitor

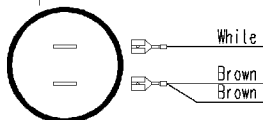

Half load button

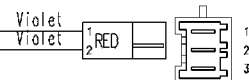

Junction box

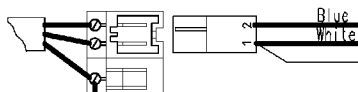

ON/OFF button

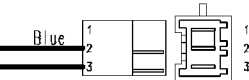

Earth

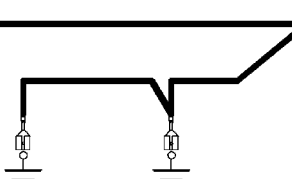

Tub earth Cold water inlet valve

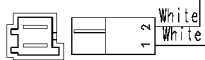

Pilot lamp

