

Heating elements

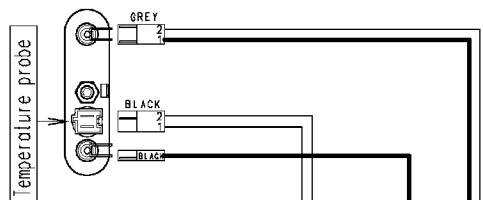

Motor

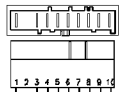

132.12610/

Door locked lamp

37928592/



Drain pump

132.12671/

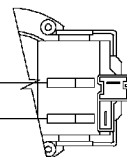

MAIN ELECTRONIC BOARD

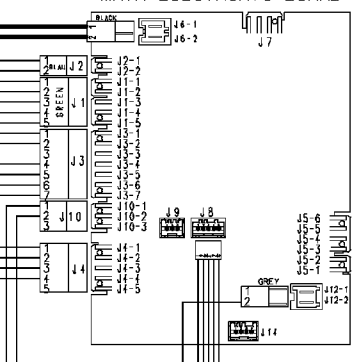

Pressure switch

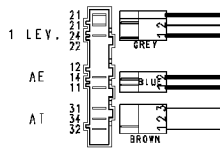

132.12620/

Anti-interference filter



132.12742/

Earth

124.11050/

124.34040/

Junction box

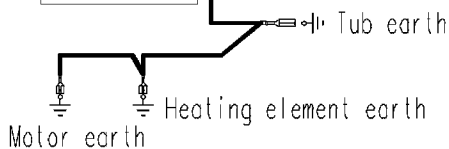

Programme selector

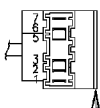

USER INTERFACE BOARD

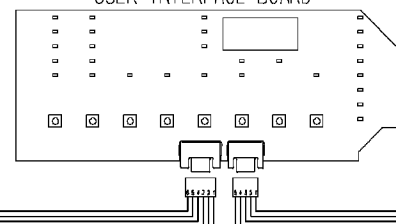

124.93313/

124.93311/

132.12630/

Prewash valve  
Wash valve

