

Spin Reduction Button

Half load button

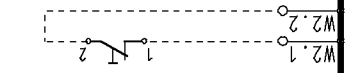

Timer & Electronic module

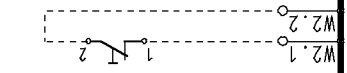
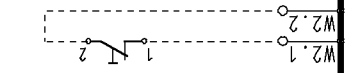
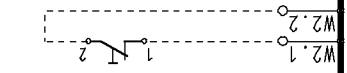
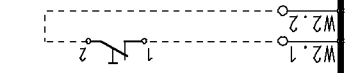
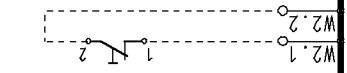
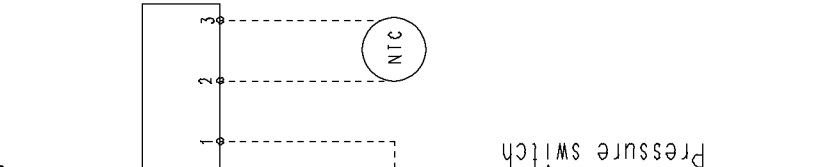
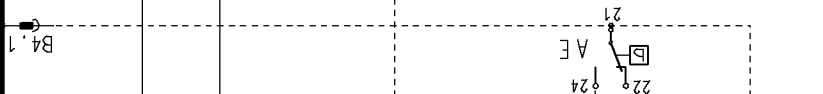
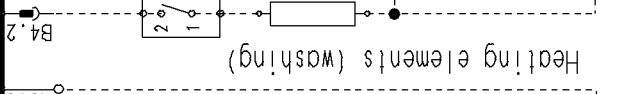
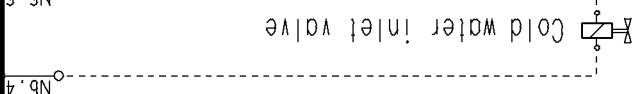
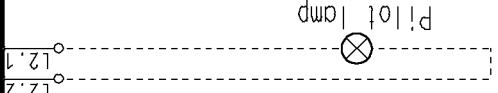
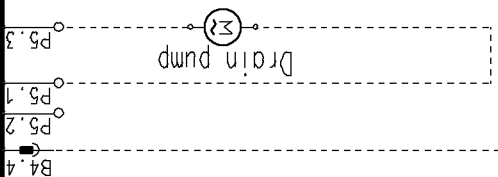
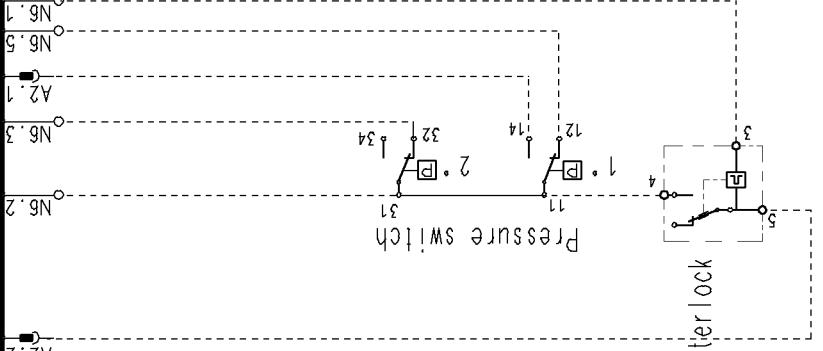
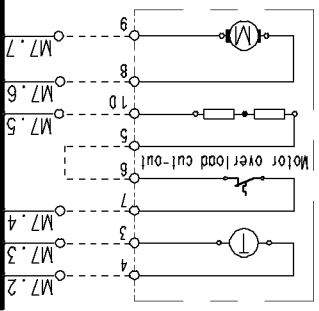

Adjustable thermostat

Motor

Pressure switch

ON-OFF button

Drain pump

Pilot lamp

Cold water inlet valve

Heating elements (washing)

Pressure switch

NTC

Door safety interlock

