

Motor

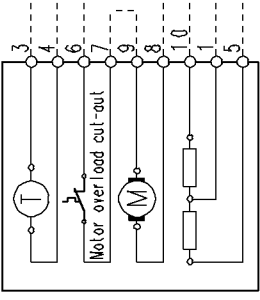

Pressure switch AE-2



Heating element (washing)

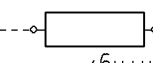

Pilot lamp



Pressure switch AE-1

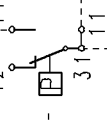

Analogic pressure level

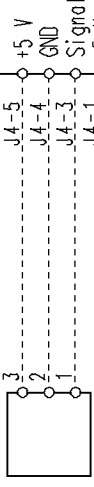

Temperature probe(washing)



Door safety interlock

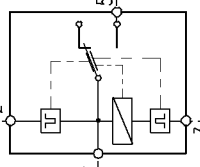

ON/OFF button

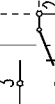

MAIN ELECTRONIC BOARD

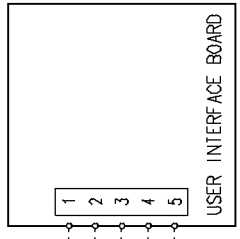
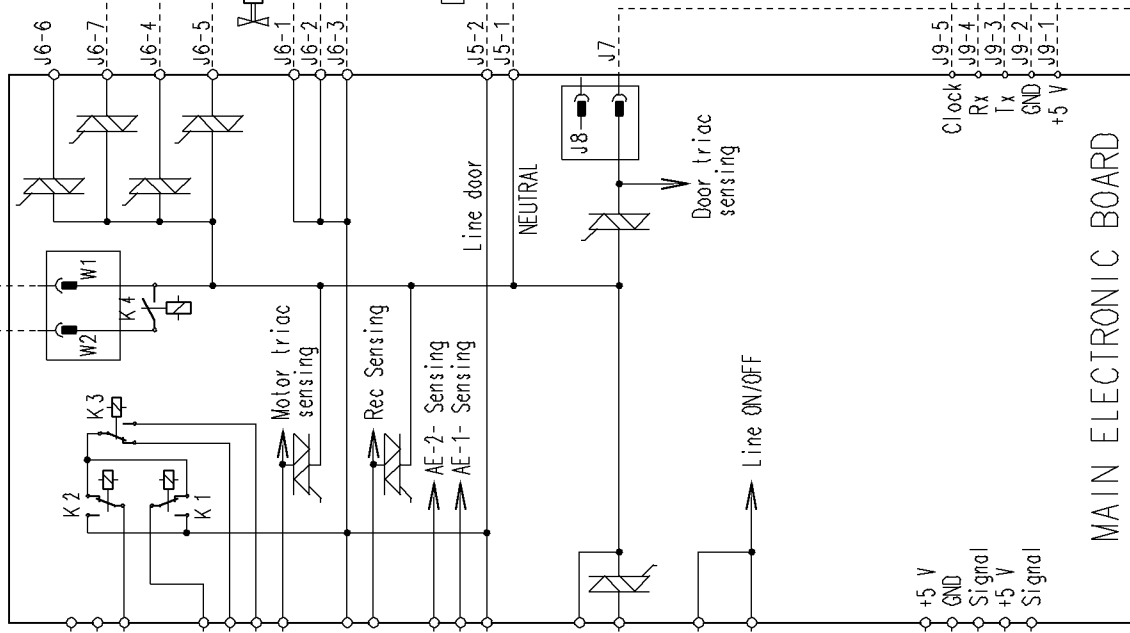

USER INTERFACE BOARD