

Anti-interference filter

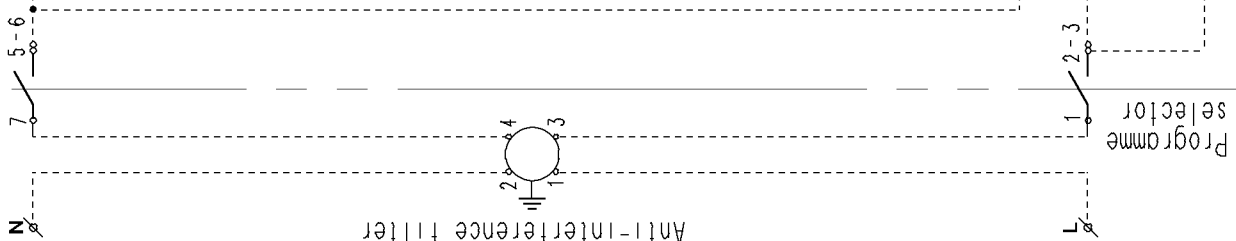

Programme selector

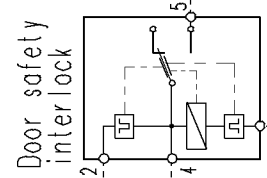

Pressure switch
AE-1

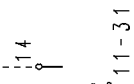

Heating element (washing)

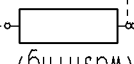

Pressure switch
AE-2

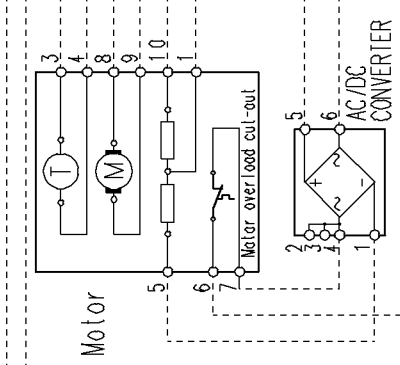

Motor

Analogic pressure level

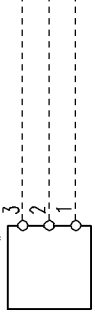

Temperature probe (washing)



MAIN ELECTRONIC BOARD

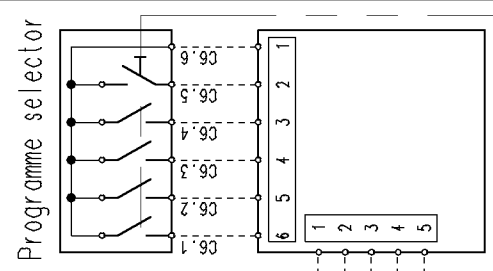
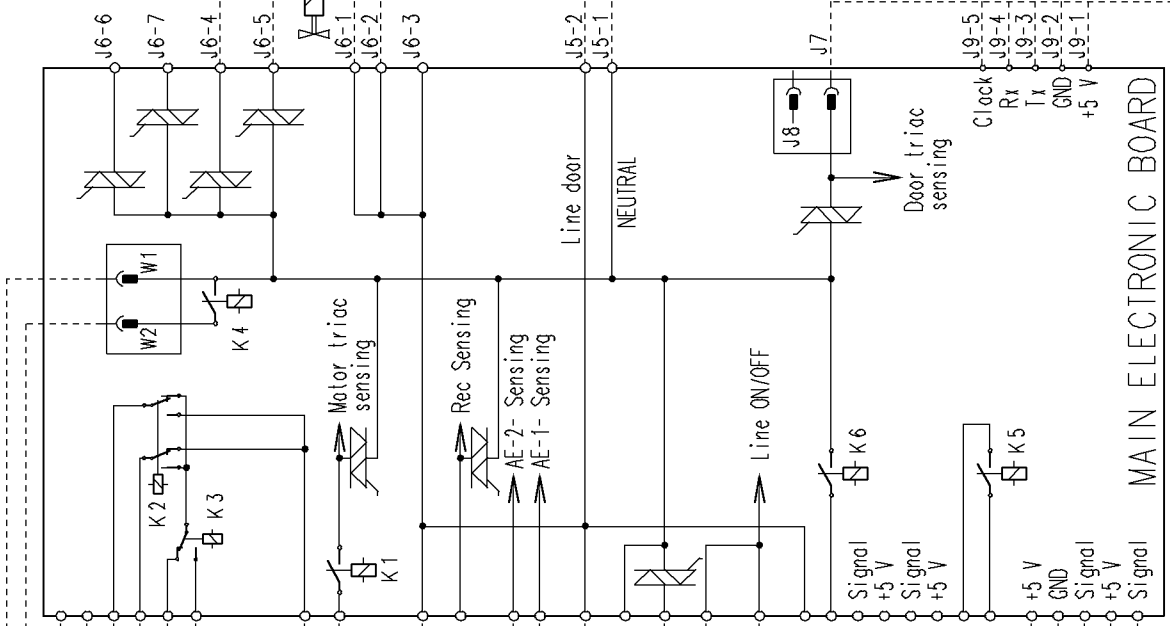

Programme selector

N

