

124.33690/  
124.33692/  
124.33940/

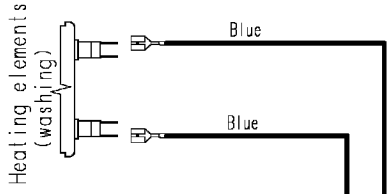

Door safety interlock

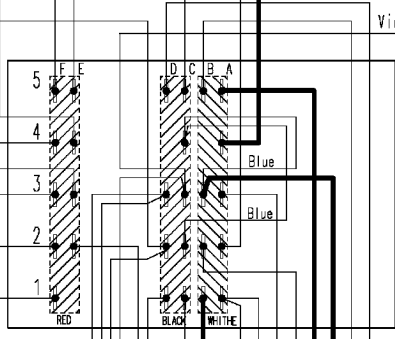
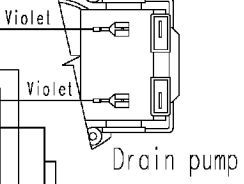
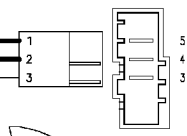

Pilot lamp

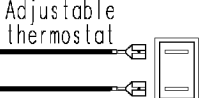

Super rinsing button

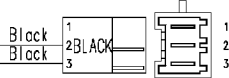

No-spin button

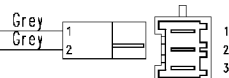

Half load button

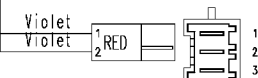

ON-OFF button

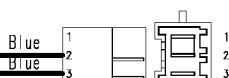

Pressure switch

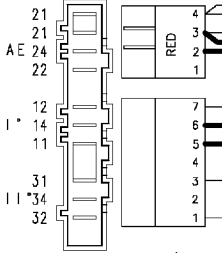

Capacitor

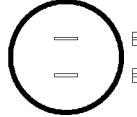

Junction box

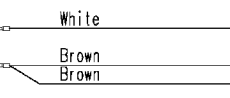
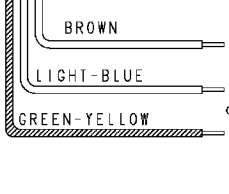

Cold water inlet valve



EARTH CONNECTION FOR "INOX" TUB

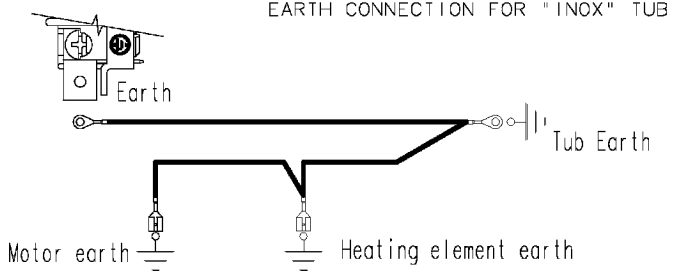

EARTH CONNECTION FOR "CARBORAN" TUB

