

Motor

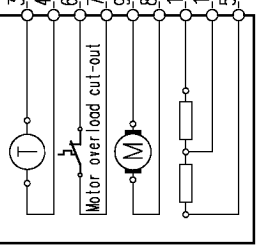

Pressure switch AE-2

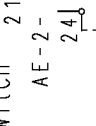

Heating element (washing)

Pilot lamp

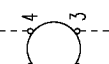

Pressure switch AE-1

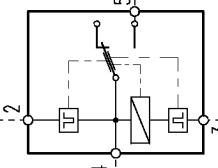
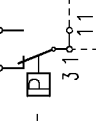

Door safety interlock

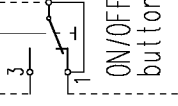

ON/OFF button

Recirculation pump



Drain pump



Analogic pressure level

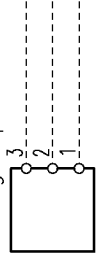

Temperature probe(washing)

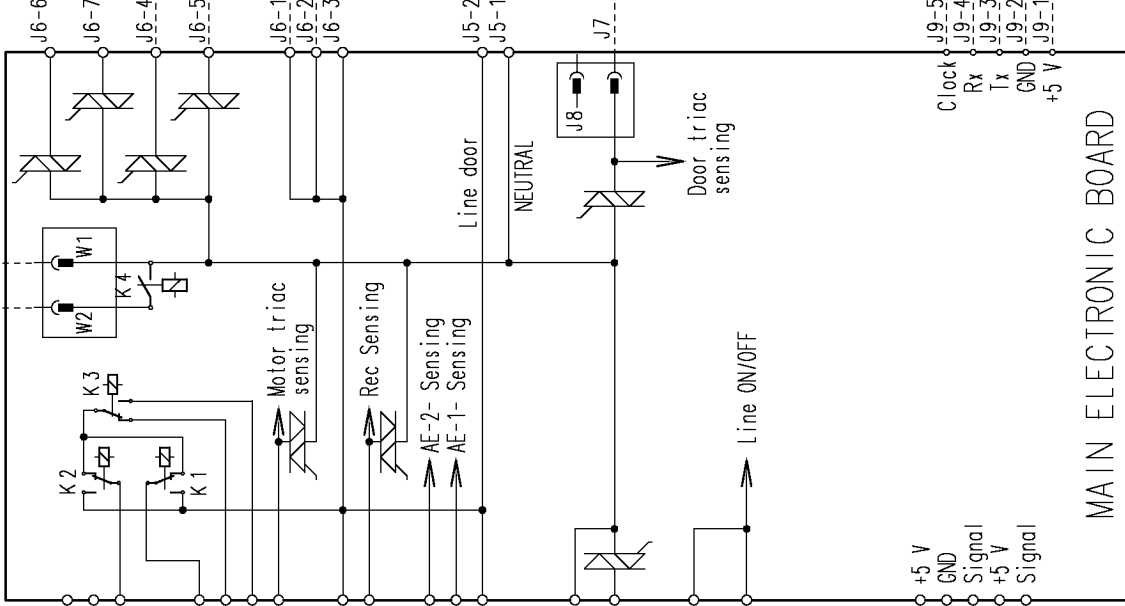
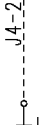

MAIN ELECTRONIC BOARD

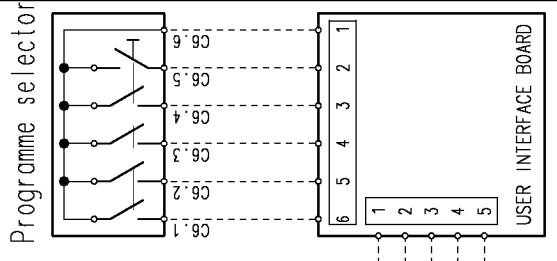

Programme selector

USER INTERFACE BOARD

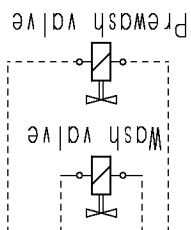

Wash valve

Prewash valve

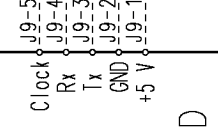

C lock

Rx

Tx

GND

+5 V

Door triac sensing

Line door

NEUTRAL

Line ON/OFF

J6-6

J6-7

J6-4

J6-5

J6-1

J6-2

J6-3

J5-2

J5-1

J7

J9-5

J9-4

J9-3

J9-2

J9-1

J1-8

J1-7

J1-6

J1-5

J1-4

J1-3

J1-2

J1-9

J1-1

J2-5

J2-6

J2-1

+5 V

GND

Signal

+5 V

Signal

Motor triac sensing

Rec Sensing

AE-2- Sensing

AE-1- Sensing

Door triac sensing

J8

W1

W2

K3

K4

K2

K1

Line door

NEUTRAL

J8

+5 V

GND

Signal

+5 V

Signal