

A02635001

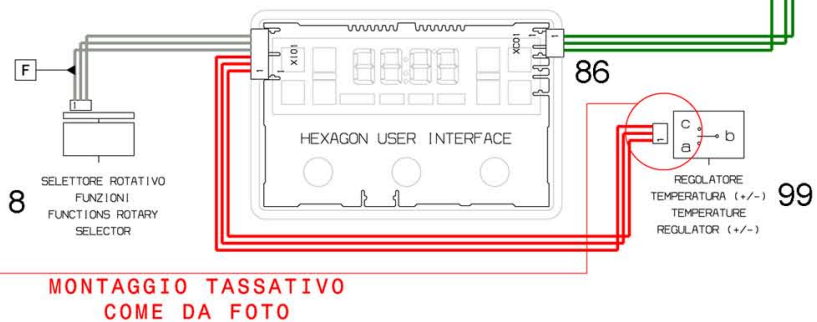
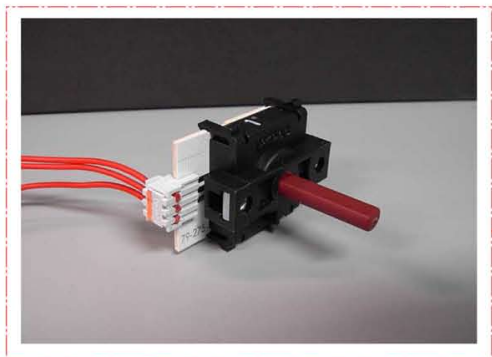
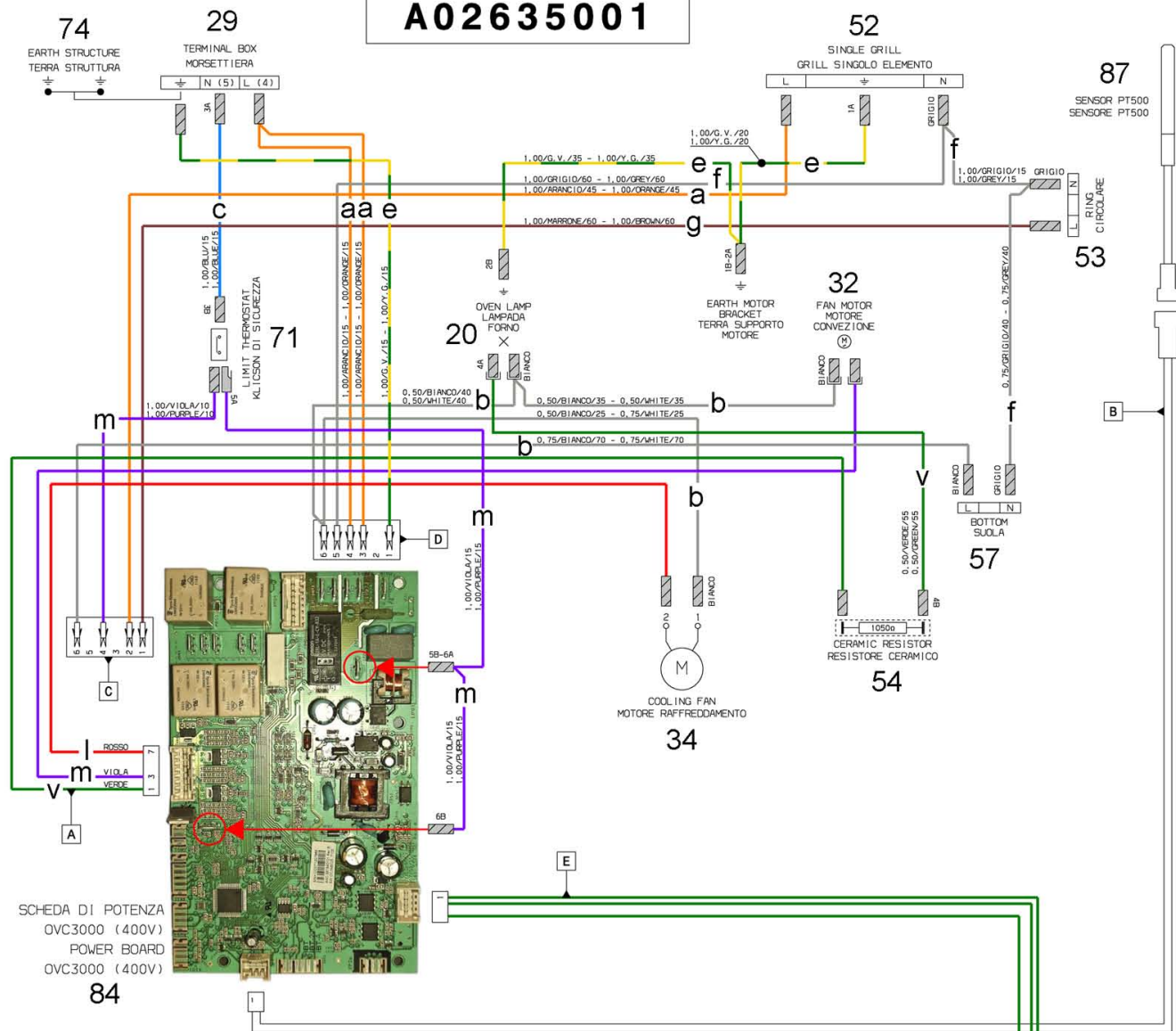

**MONTAGGIO TASSATIVO
COME DA FOTO**