

808120801 circuit diagram

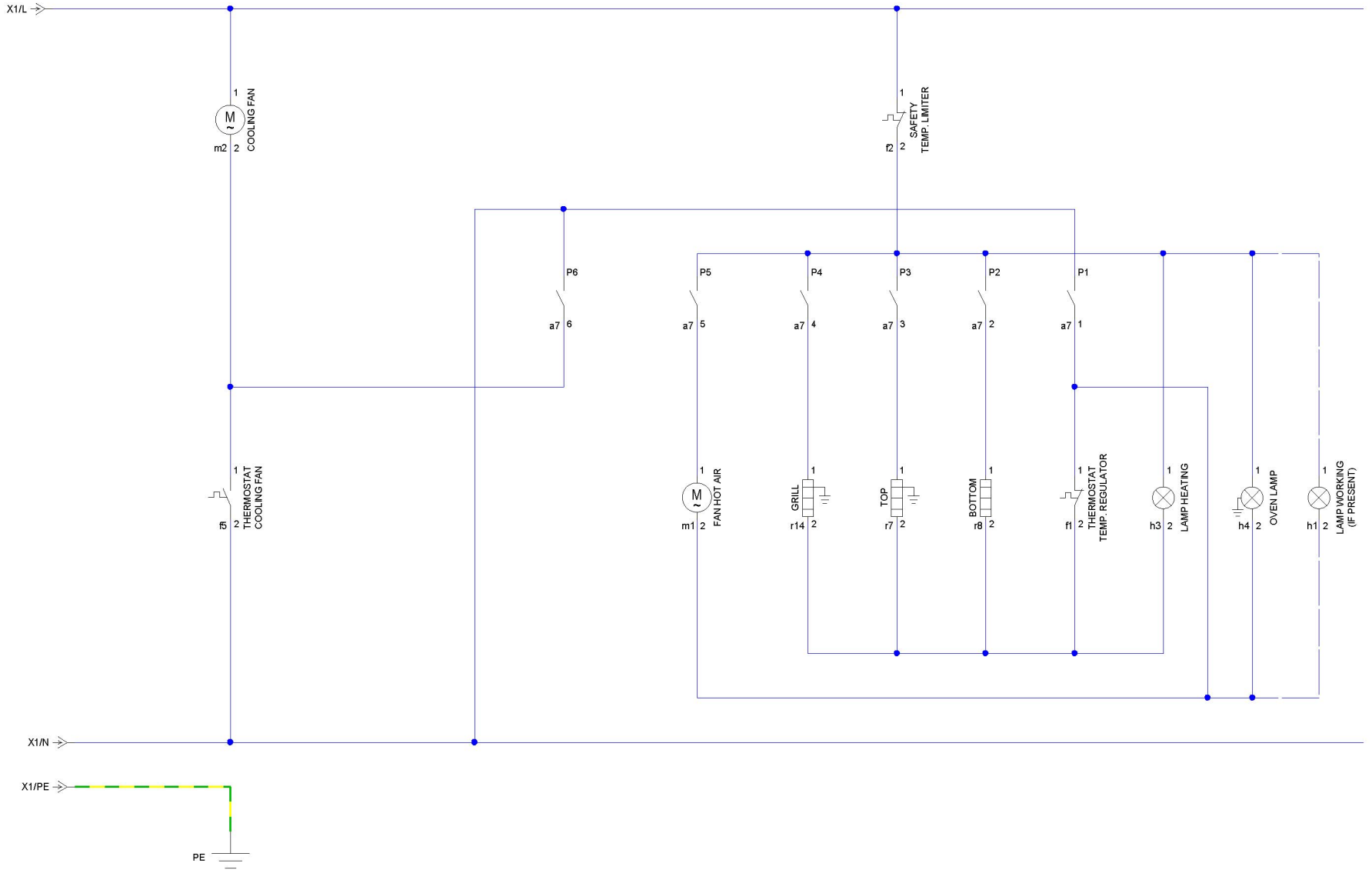

a7: FUNCTIONS SELECTOR WITH ELECTROLUX
PART NUMBER 807179703