

808179401 circuit diagram

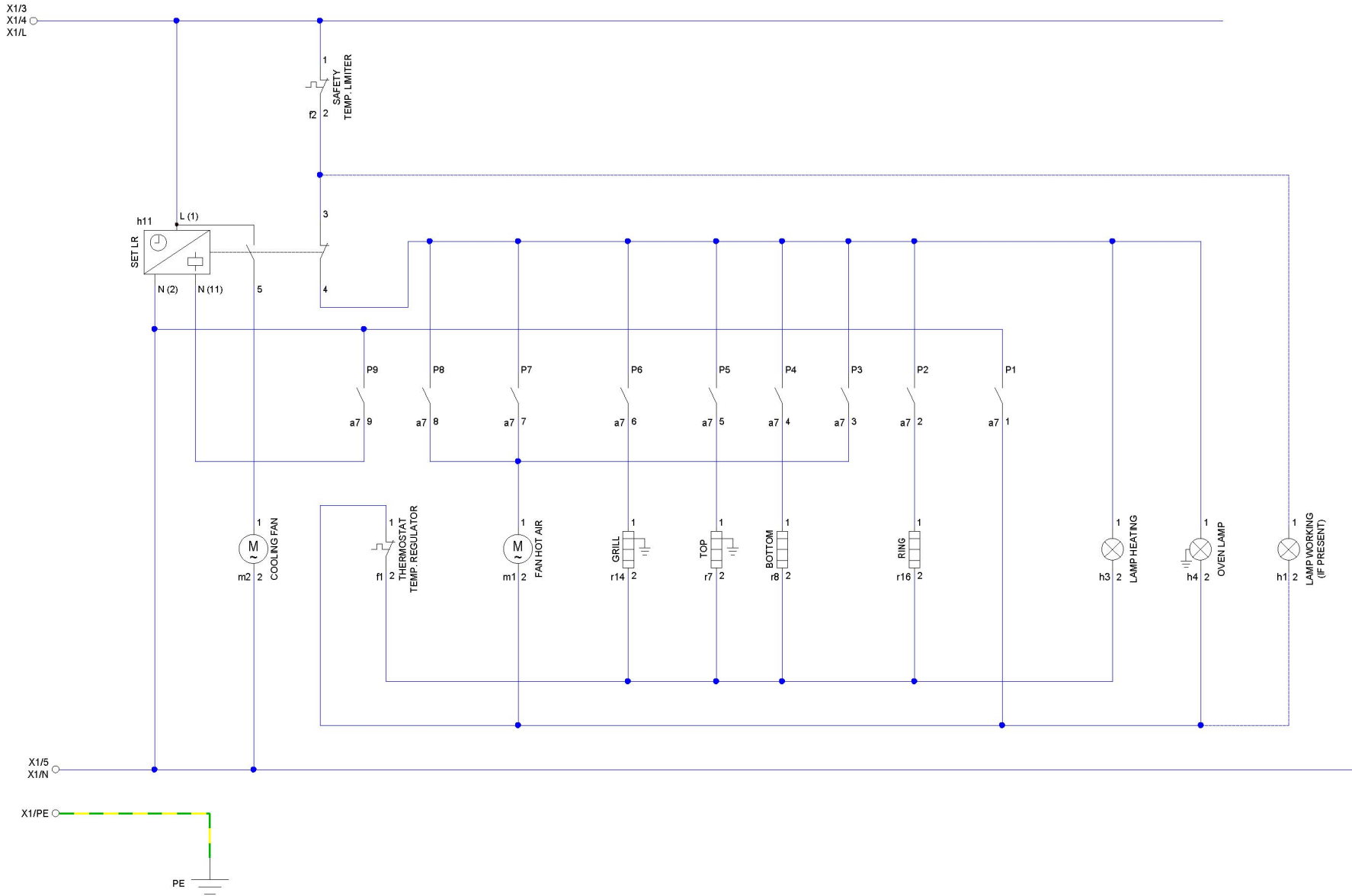

a7: FUNCTIONS SELECTOR WITH ELECTROLUX
PART NUMBER 807180604