

# 808126901 circuit diagram

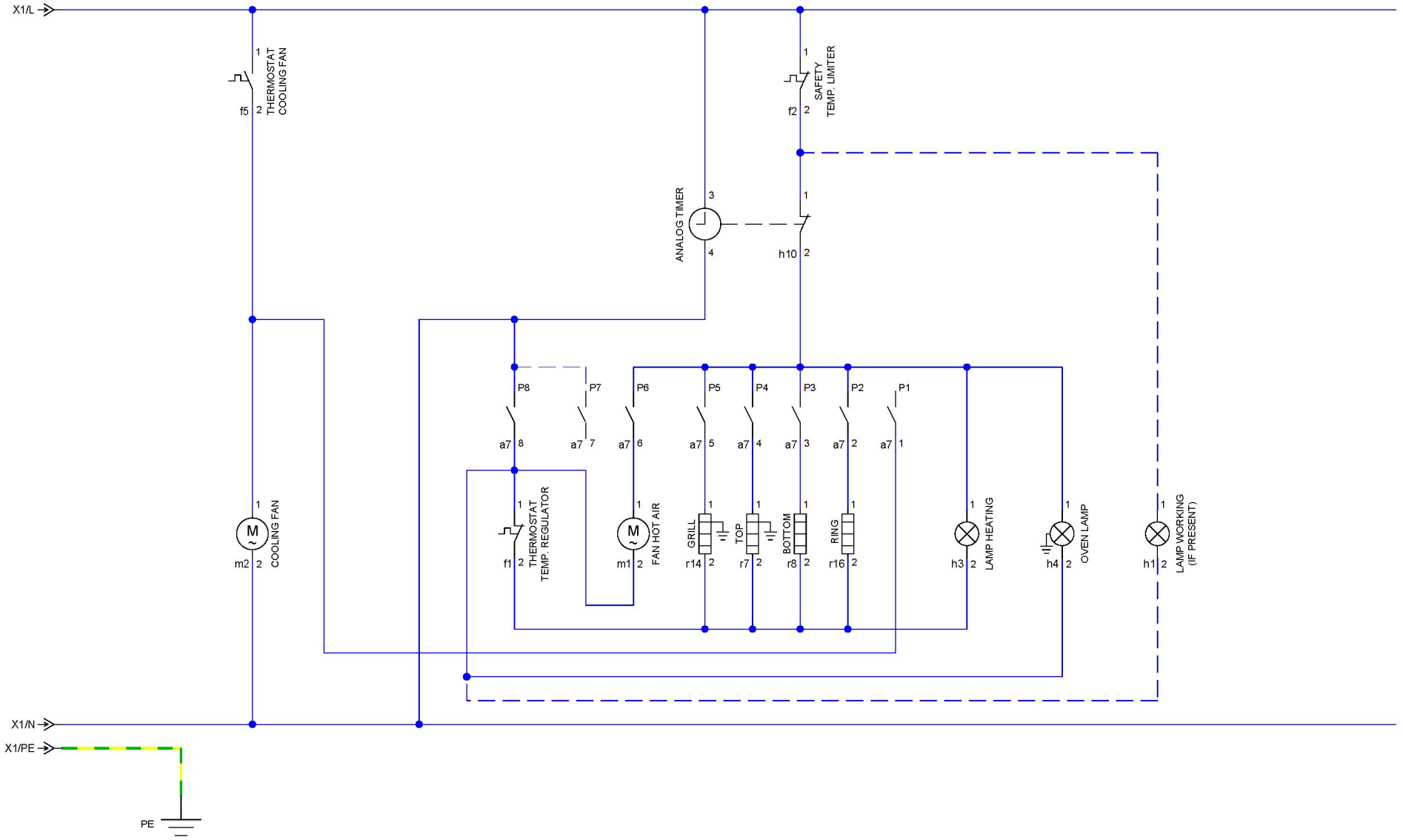

a7: FUNCTIONS SELECTOR WITH ELECTROLUX  
PART NUMBER 807180601