

WIRING

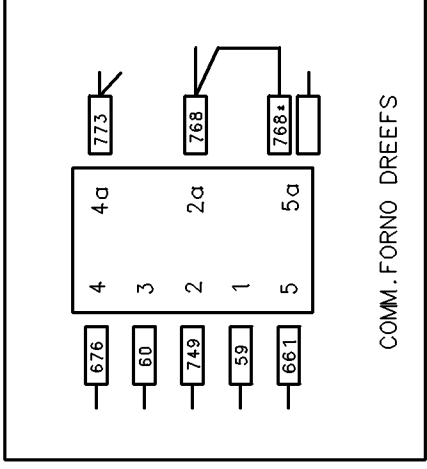

Δ	0	60	120	180	240	300
4 - P2						
3 - P1						
1 - P1						
2 - P1						
5 - P3						

357 411801a