

# WIRING HARNESSSES

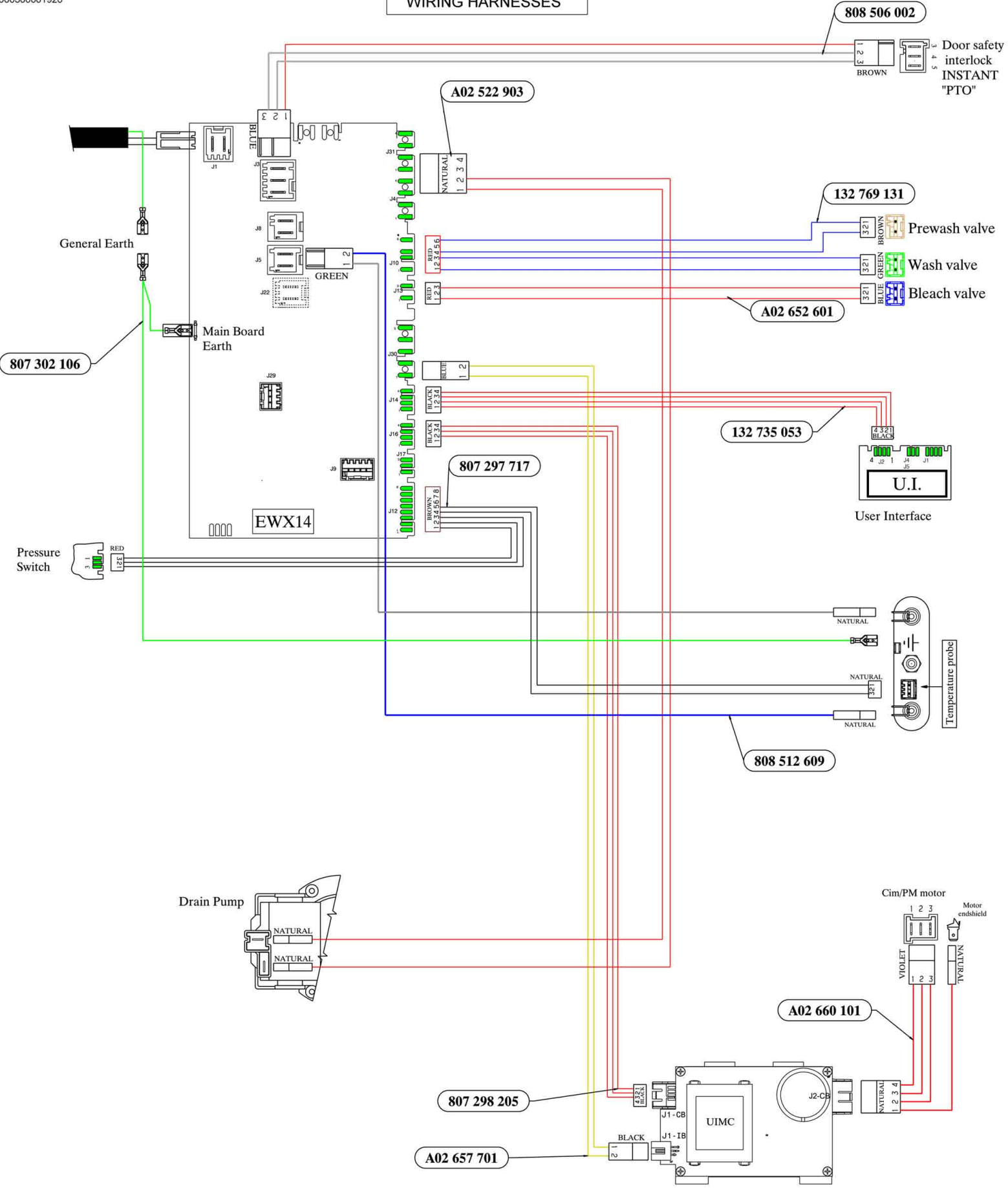

808 506 002

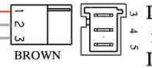

Door safety interlock  
INSTANT "PTO"

A02 522 903

132 769 131



Prewash valve



Wash valve



Bleach valve

A02 652 601

132 735 053

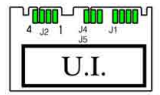

User Interface

807 297 717

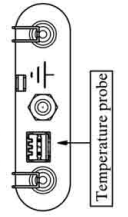

Temperature probe

808 512 609

Drain Pump

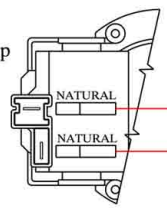

Cim/PM motor

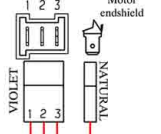

A02 660 101

807 298 205

A02 657 701

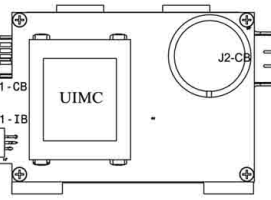

UIMC