

SERVICE-DOKUMENTATION

ALLGEMEINE BESCHREIBUNG

- Fertigungsdatum : 03/02
- Normen : CE
- Typ : Dampföfen
- Farbe : Inox
- Ofenbeleuchtung : Ja
- Programmschalter : Ja
- Bratspieß : Nein
- Traggitter : Ja
- Mehrzweck-Fettpfanne : Nein
- Fettpfanne + Gitter + Griff : Nein
- Backblech : Nein
- Blech : Nein
- Glasplatte : Nein
- Lochblech : Ja
- Gittereinschübe : Nein
- Reinigungsart : -
- Diagnosehilfe : -

ABMESSUNGEN

	Außen	Nische	Hohlraum großer Ofen	Hohlraum kleiner Ofen
Höhe	390 mm	380 mm	185 mm	-
Breite	595 mm	560 mm	390 mm	-
Tiefe	470 mm	450 mm	325 mm	-

- Nutzraum großer Ofen : 23 l
- Nettogewicht : 20 kg
- Bruttogewicht : 23 kg

- Nutzraum kleiner Ofen : -

ELEKTRISCHER ANSCHLUSS

- Schnur : Ja
- (Einphasen) Spannung : 230 V
- Frequenz : 50 Hz
- Stärke : 10 A
- Leistung : 2030 W

ELEKTRISCHE KENNGRÖSSEN DES OFENS

- Großer Ofen
 - Decke / Grill : -
 - Sohle : -
 - belüftetes Teil : -

- Kleiner Ofen
 - Decke / Grill : -
 - Sohle : -

VERBRAUCH

- Anstieg auf 200 °C :
- Halteverbrauch 200 °C :
- * bei Raumtemperatur 20 °C
- Pyrolyse 80 Minuten :
- Dampföfen :
- Anstieg+halteverbrauch auf 100 °C : 1,1 kW/h

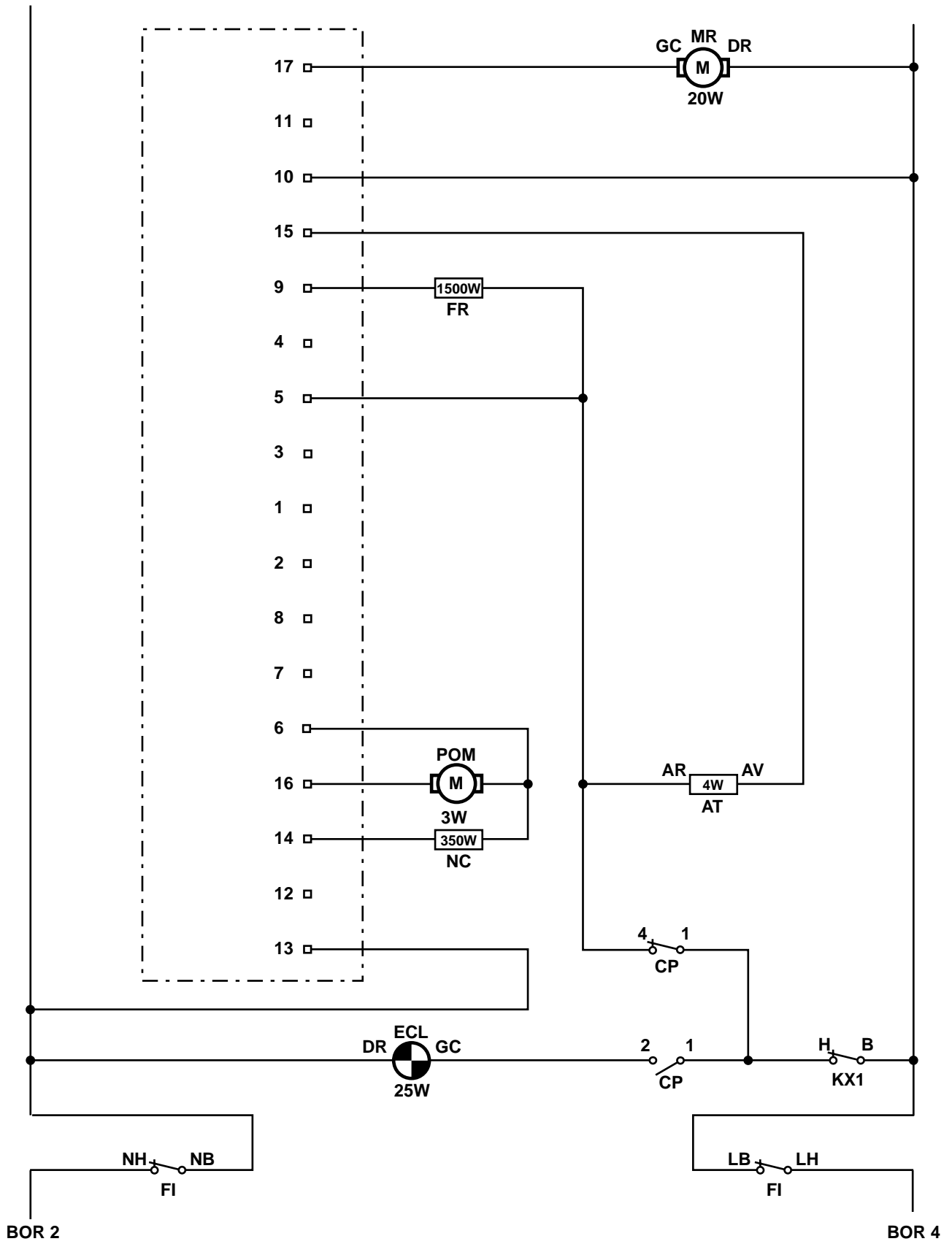

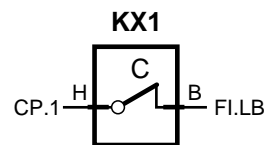
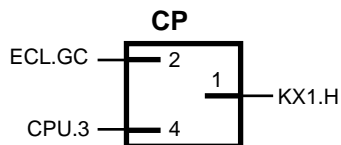
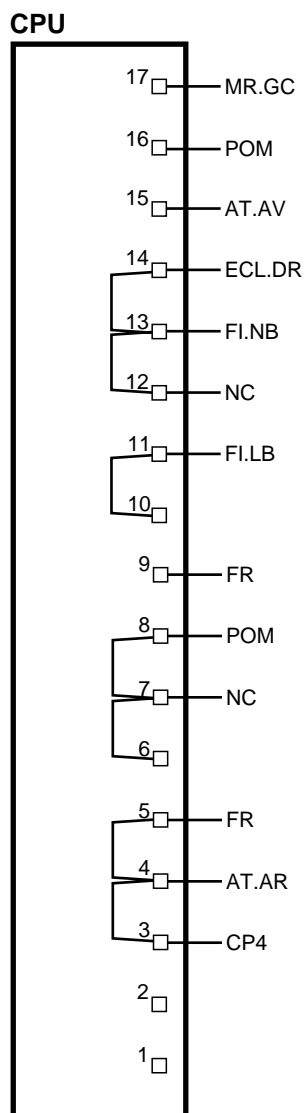
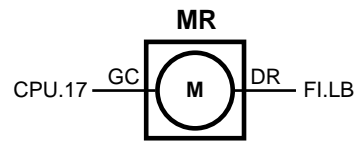
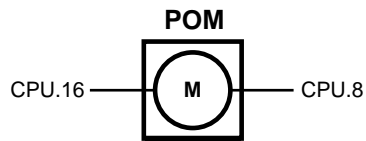
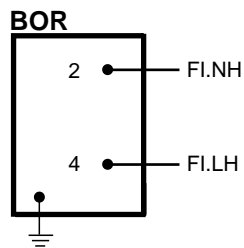

T0838595 C

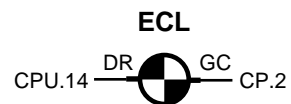
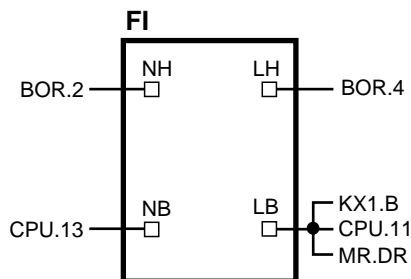
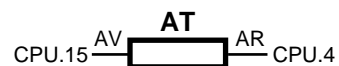
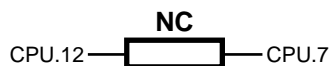

LEGENDE

- AT : ACTIVATEUR THERMO-ELECTRIQUE
- BOR : BORNIER
- CPU : CARTE ELECTRONIQUE
- CP : MINIRUPTEUR
- ECL : LAMPE
- FI : FILTRE ANTIPARASITES
- FR : GENERATEUR
- KX1 : KLIXON
- MR : TURBINE
- NC : NAPPE CHAUFFANTE
- POM : POMPE

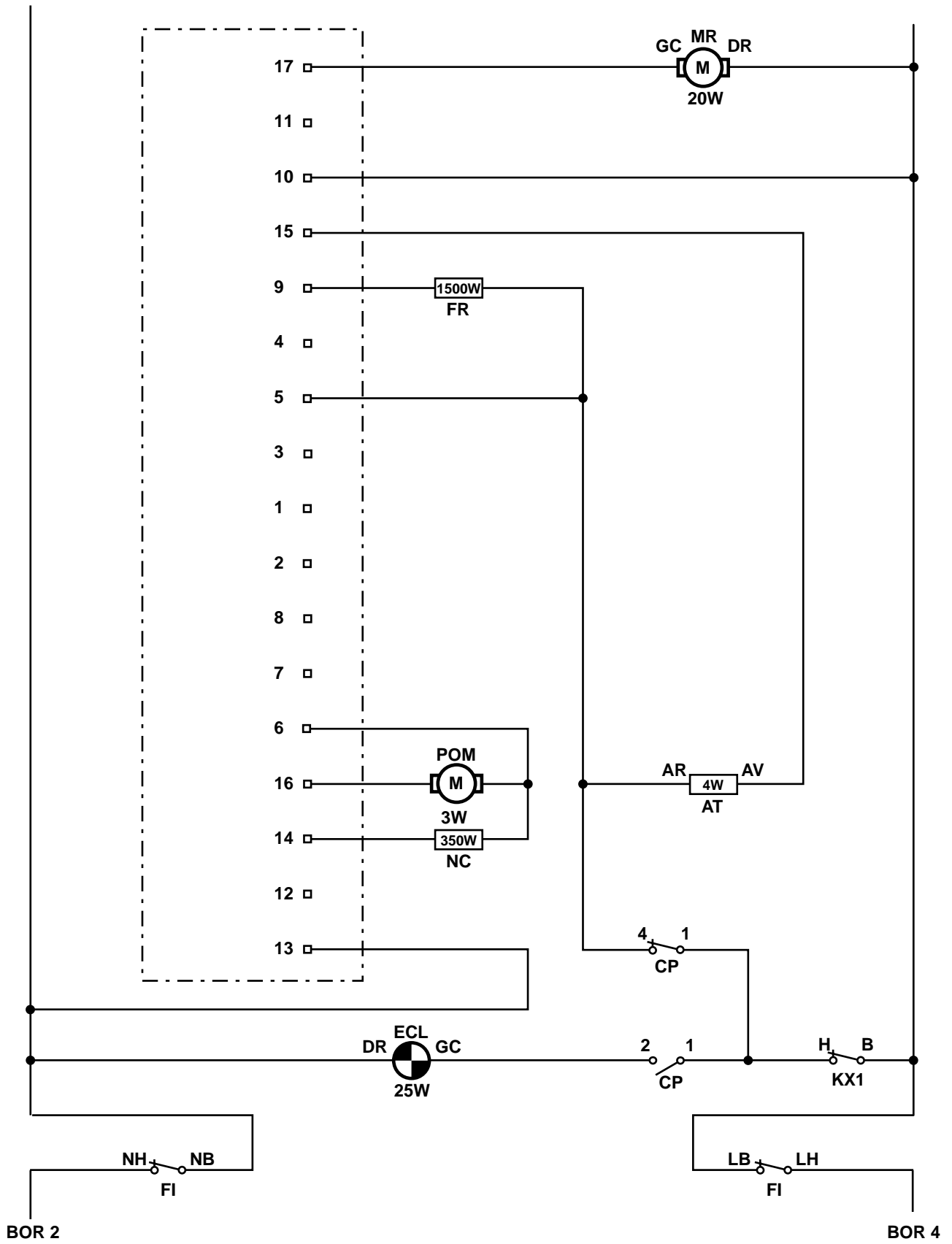

BOR

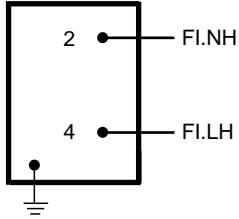

POM

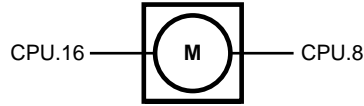

MR

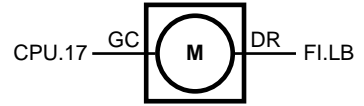

CPU

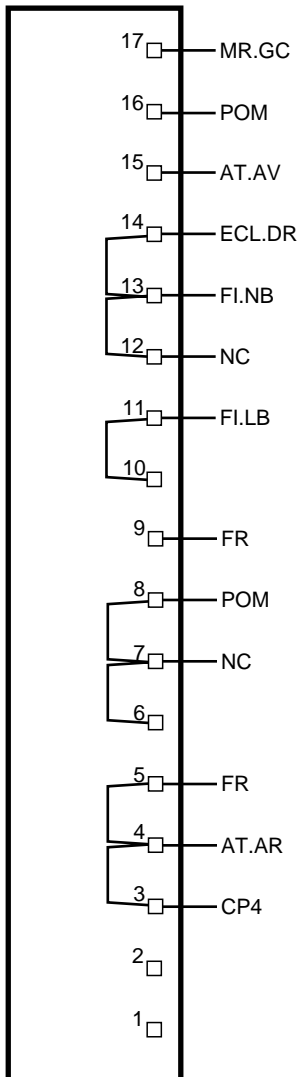

CP

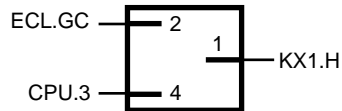

KX1

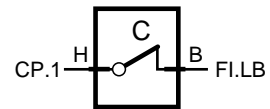

T0838595 C

NC



AT



FI

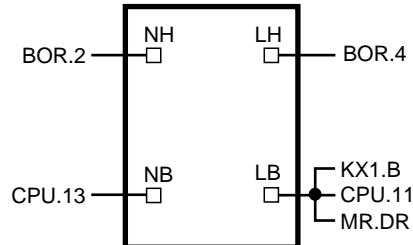

FR



ECL



LEGENDE

- AT : THERMOELEK. AKTIVATOR
- BOR : SCHALTER
- CPU : STEUERKARTE
- CP : MINISCHALTER
- ECL : LAMPE
- FI : ENTSTÖRUNGSFILTER
- FR : GENERATOR
- KX1 : KLIXON
- MR : TURBINE
- NC : HEIZSCHLANGE
- POM : PUMPE