

Trommel-
beleuchtung
(Fassung 5154154)
(Lampe E630349)
Washing liquor tank
Lighting
(Lamp socket 5154154)
(Lamp E630349)

Türöffner
Door Lock
(E630093)
Links
left
rechts
right
nach Umbanden
change the setting

Motor
Motor
(E630231)
2-3: 19a...25a
2-4: 18a...23a

Primärgebläse
Primary fan
(E631091)

Heizregister Export
Heating register export
(630739)
E1: 1800W
E2: 1400W
E3: 1400W
Heizregister
Heating register
(93216075)
E1: 1600W, 31a...34a
E2: 1600W, 31a...34a
E3: 1600W, 31a...34a

Heizregister
Heating register

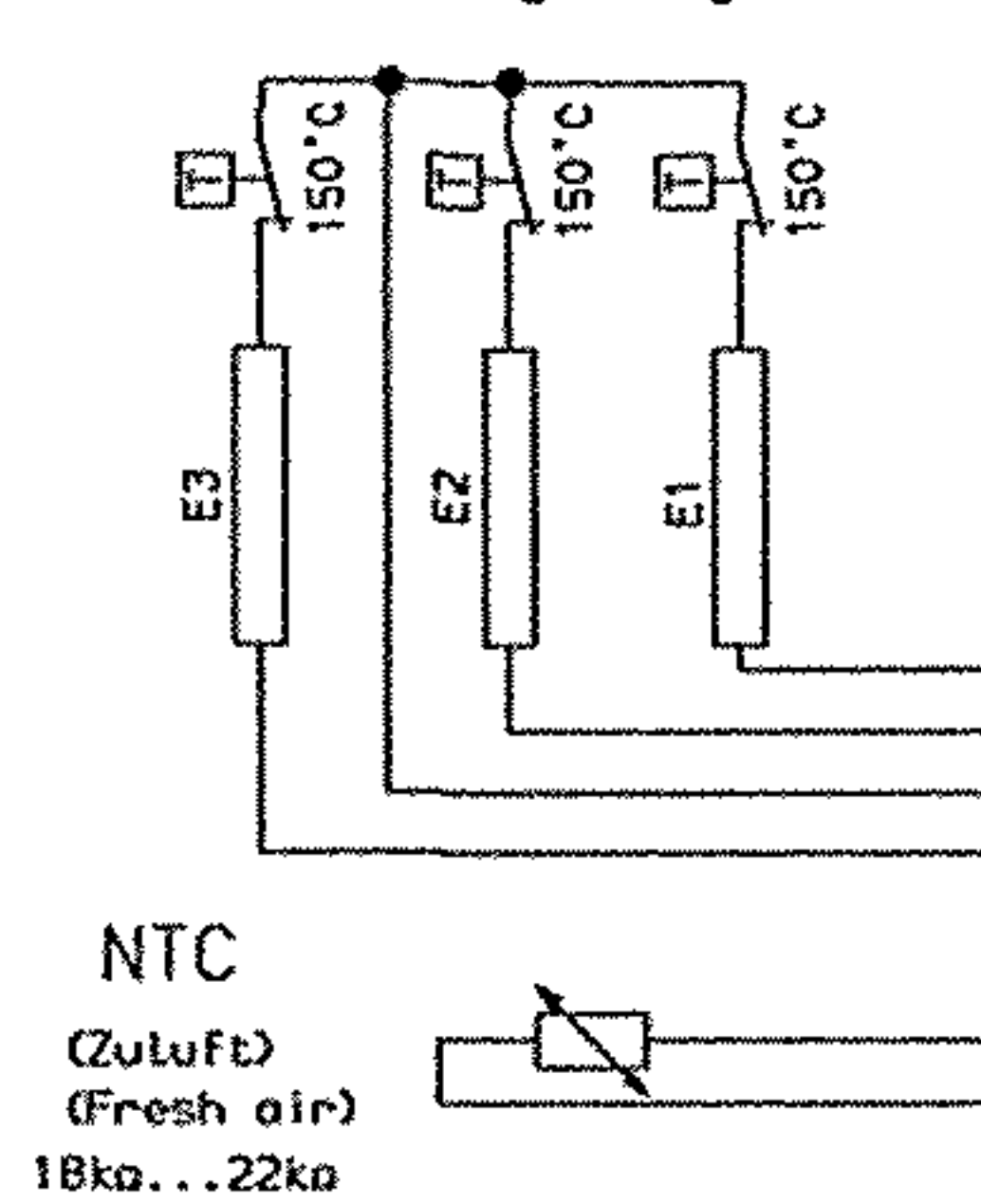

NTC
(Zuluft)
(Fresh air)
18ka...22ka

Anschlusskasten
Connection box
(630472)

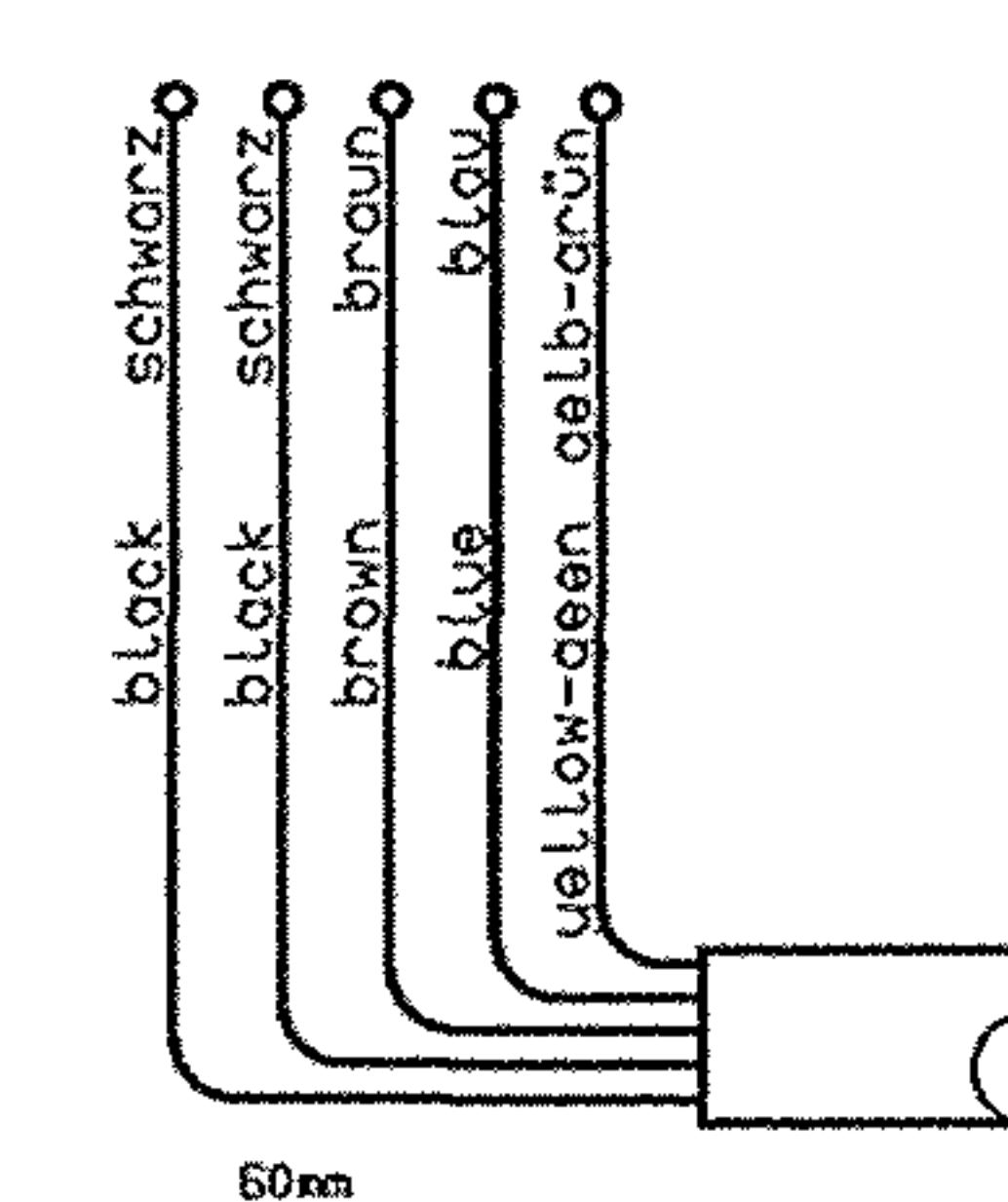
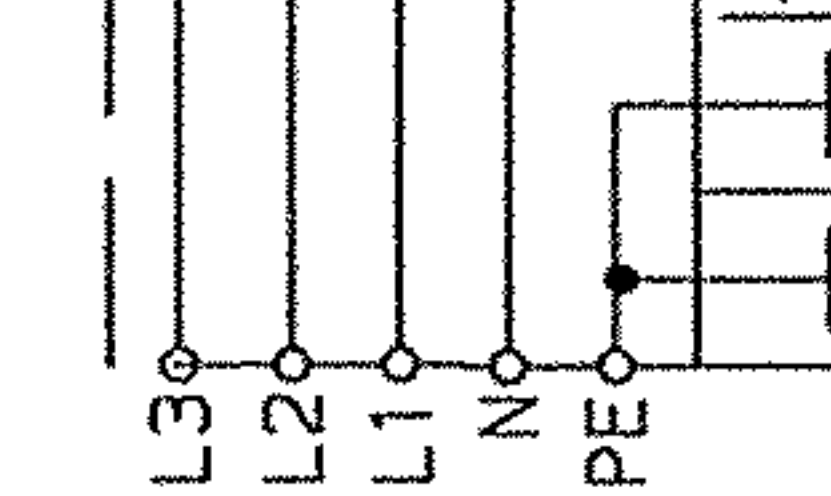

400V AC 3LN

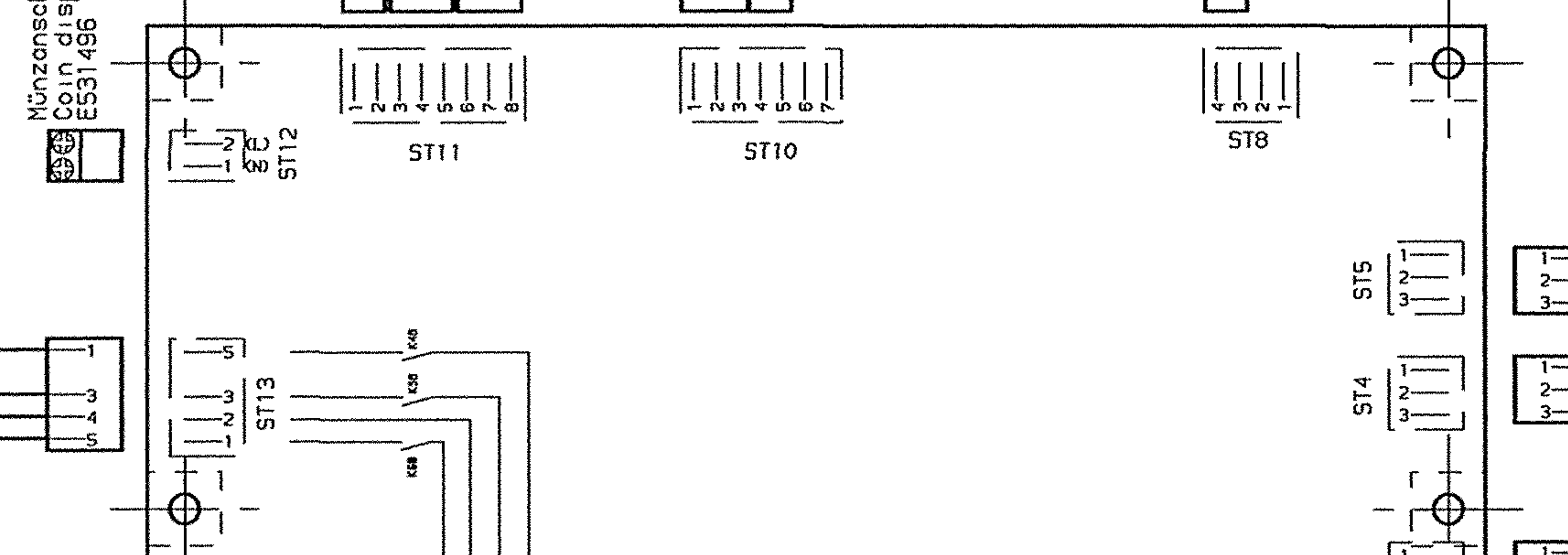
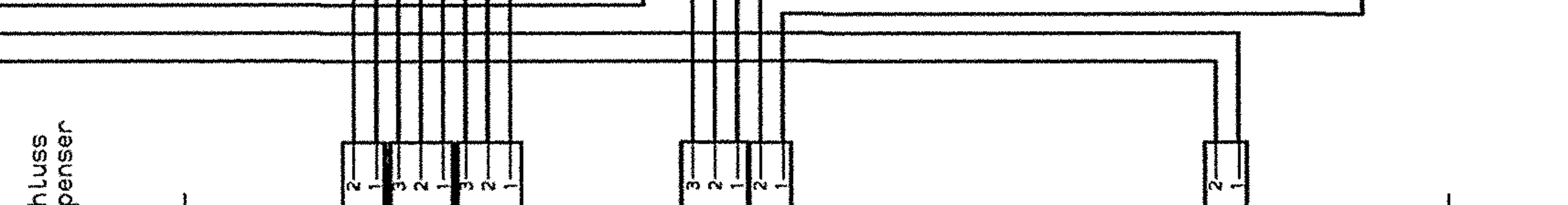
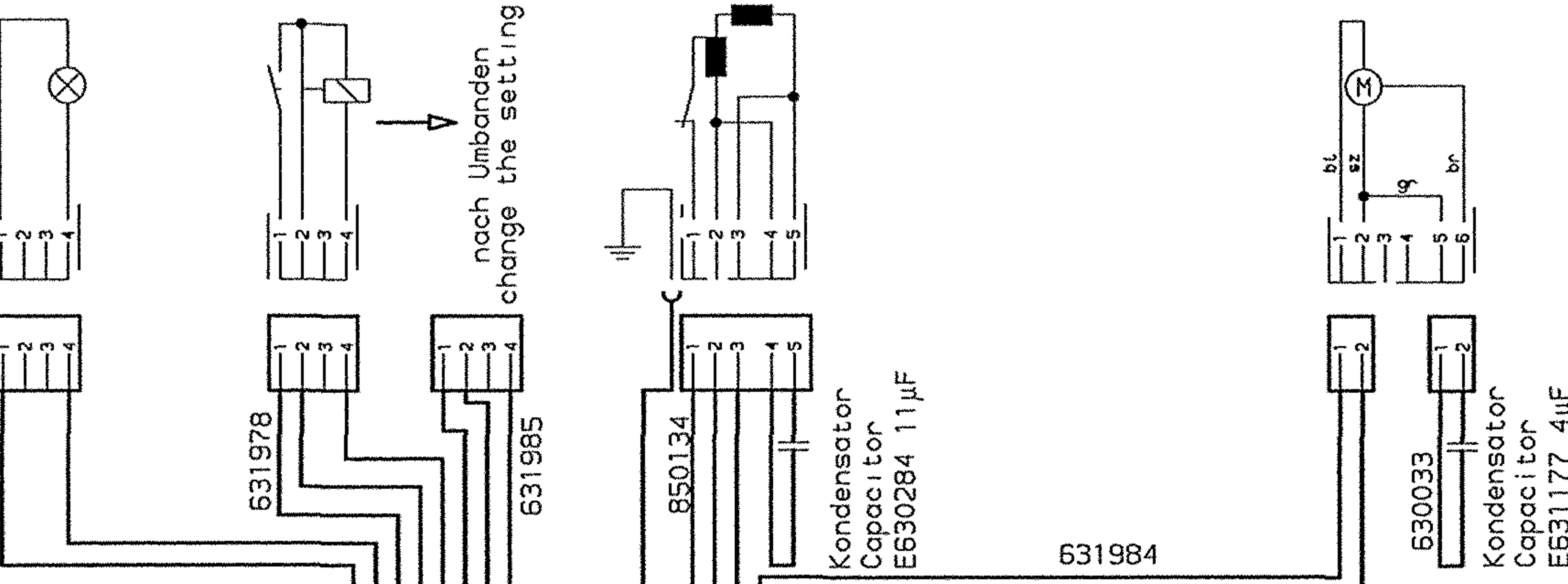

Leistungsteil WT MFH
Power card WT MFH
631691

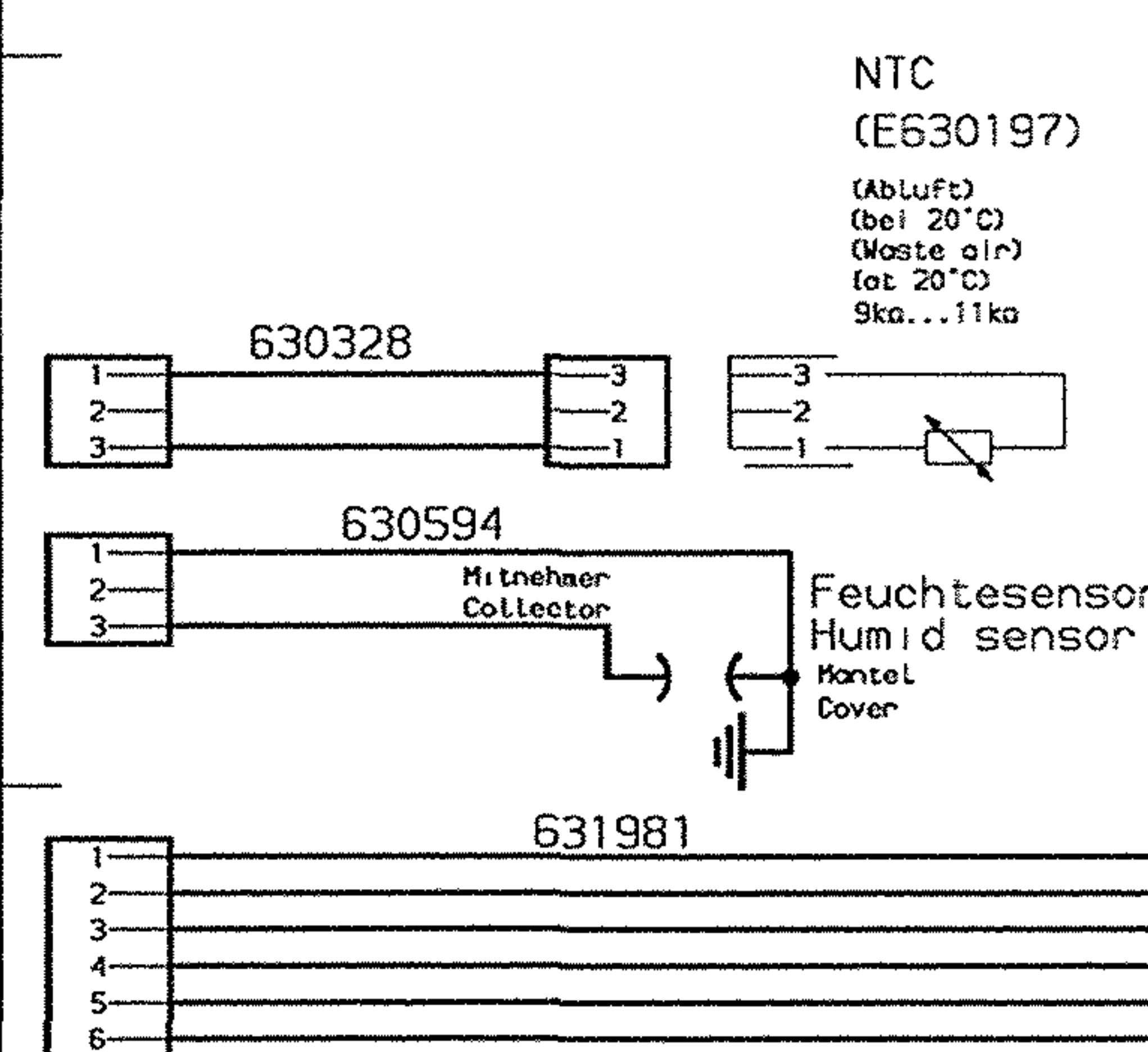

Steuerteil WA/WT
Control card WA/WT
LCD klein
LCD small
534063

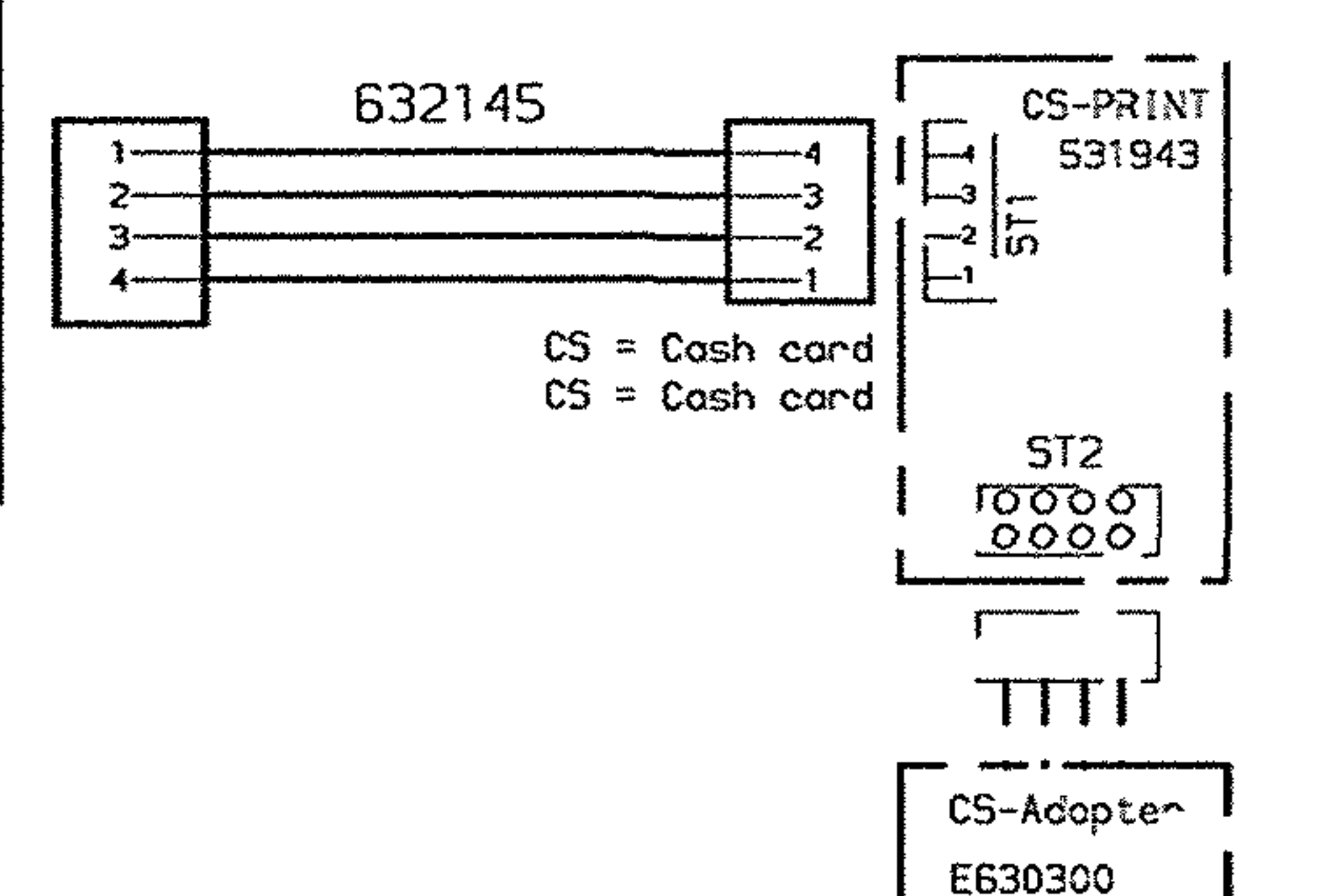

CS = Cash card
CS = Cash card