

a1 Hauptschalter

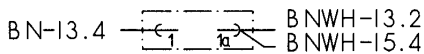

d1 PTC-Glied

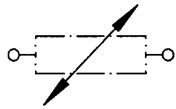

e1 Schutzschalter

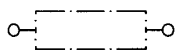

e2 Schalter " Gluehlampe "

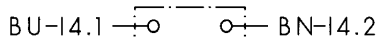

f1 E2000K- Elektronik

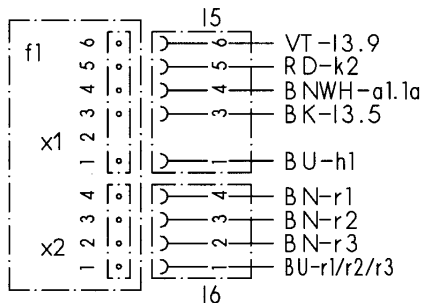

h1 Gluehlampe

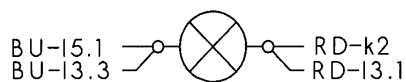

k1 Betriebskondensator

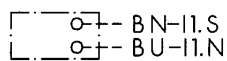

k2 Kondensator

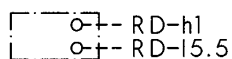

11 Anschlussteil

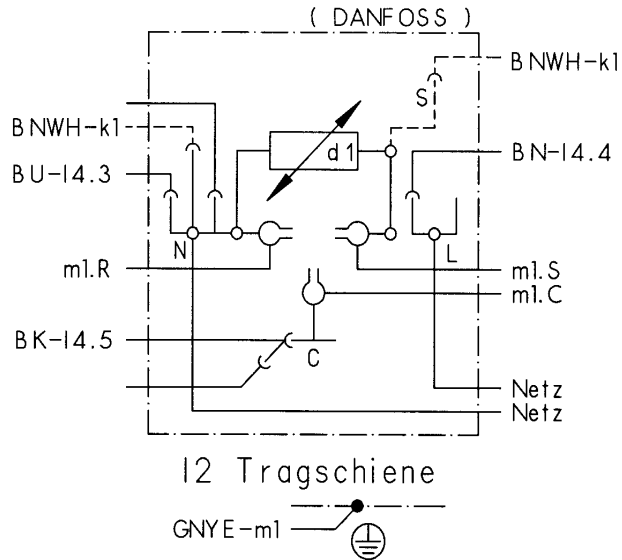

12 Tragschiene

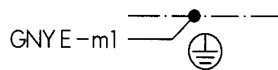

13 Buchsengehaeuse + 14 Stiftgehaeuse

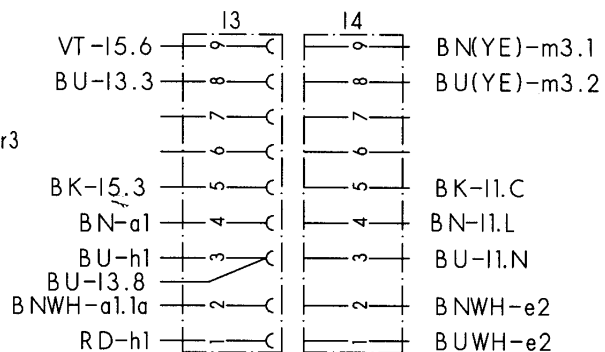

m1 Verdichter-Motor

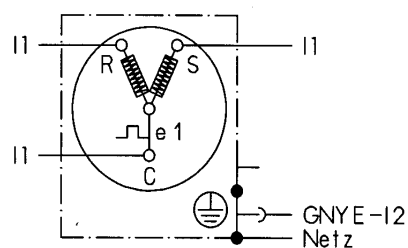

m3 Umluftventilator

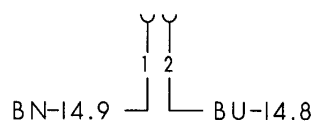
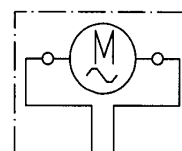

Farbe	Kurzzeichen nach DIN/IEC 757
schwarz	BK
braun	BN
rot	RD
orange	OG
gelb	YE
gruen	GN
blau	BU
violett	VT
grau	GY
weiss	WH
rosa	PK
gold	GD
tauerkis	TQ
silber	SR



1 709 911 723	07 / 01
	S0-50/1289