

d1 PTC-Glied

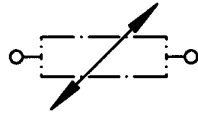

e1 Schutzschalter



e2 Schalter " Gluehlampe "

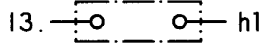

e3 Schalter " Winterswitch "

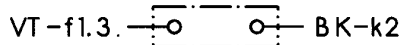

f1 Temperaturregler

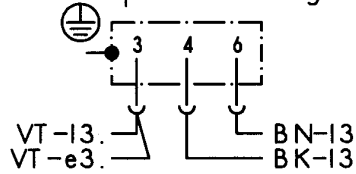

h1 Gluehlampe

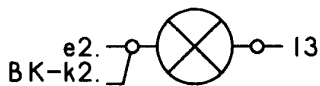

k1 Betriebskondensator

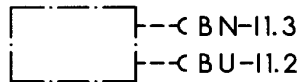

k2 Kondensator

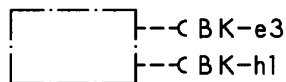

11 Anschlusssteil

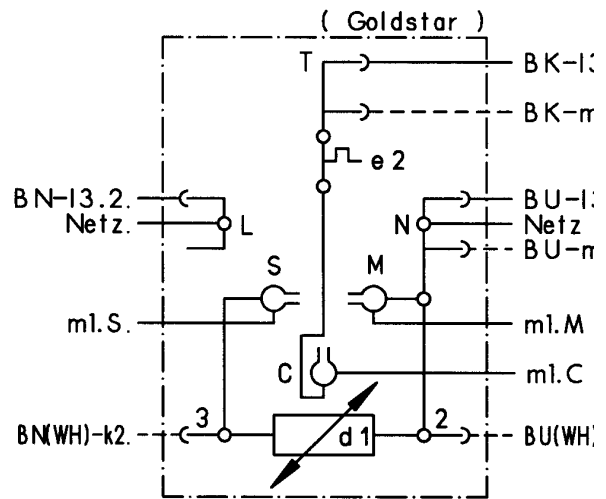

12 Tragschiene

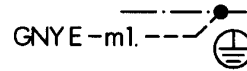

13 Steckbuchse

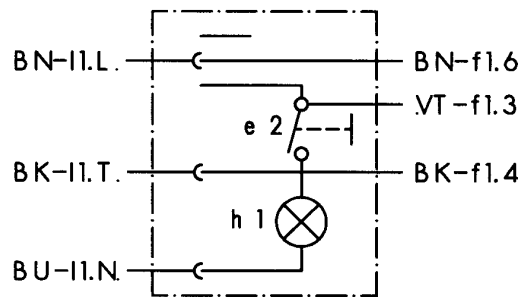

m1 Verdichter-Motor

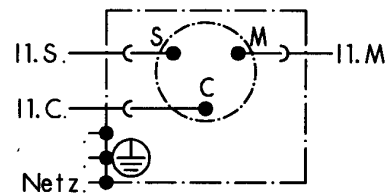

m2 Ventilator-Motor



Farbe	Kurzzeichen nach DIN/IEC 757
schwarz	BK
braun	BN
rot	RD
orange	OG
gelb	YE
gruen	GN
blau	BU
violett	VT
grau	GY
weiss	WH
rosa	PK
gold	GD
taerkis	TQ
silber	SR



1 709 911 668	05 / 99
	S0-50/0857