

b6	Door switch
b62	Rinse aid
b92	Salt aid
b96	Micro switch
c2	Heating relay
f16	Aqua control
f30	NTC
fN	Pressure Switch
fS	Safety pressure switch
h11	Internal lighting
k5	Interference filter
m3	Drain pump
m4	Transformer
m8	Circulation pump
m18	Drying fan
r13	Internal heater
s9	Regeneration valve
s11	Cold valve
T>	Turbidity sensor
X	Connector

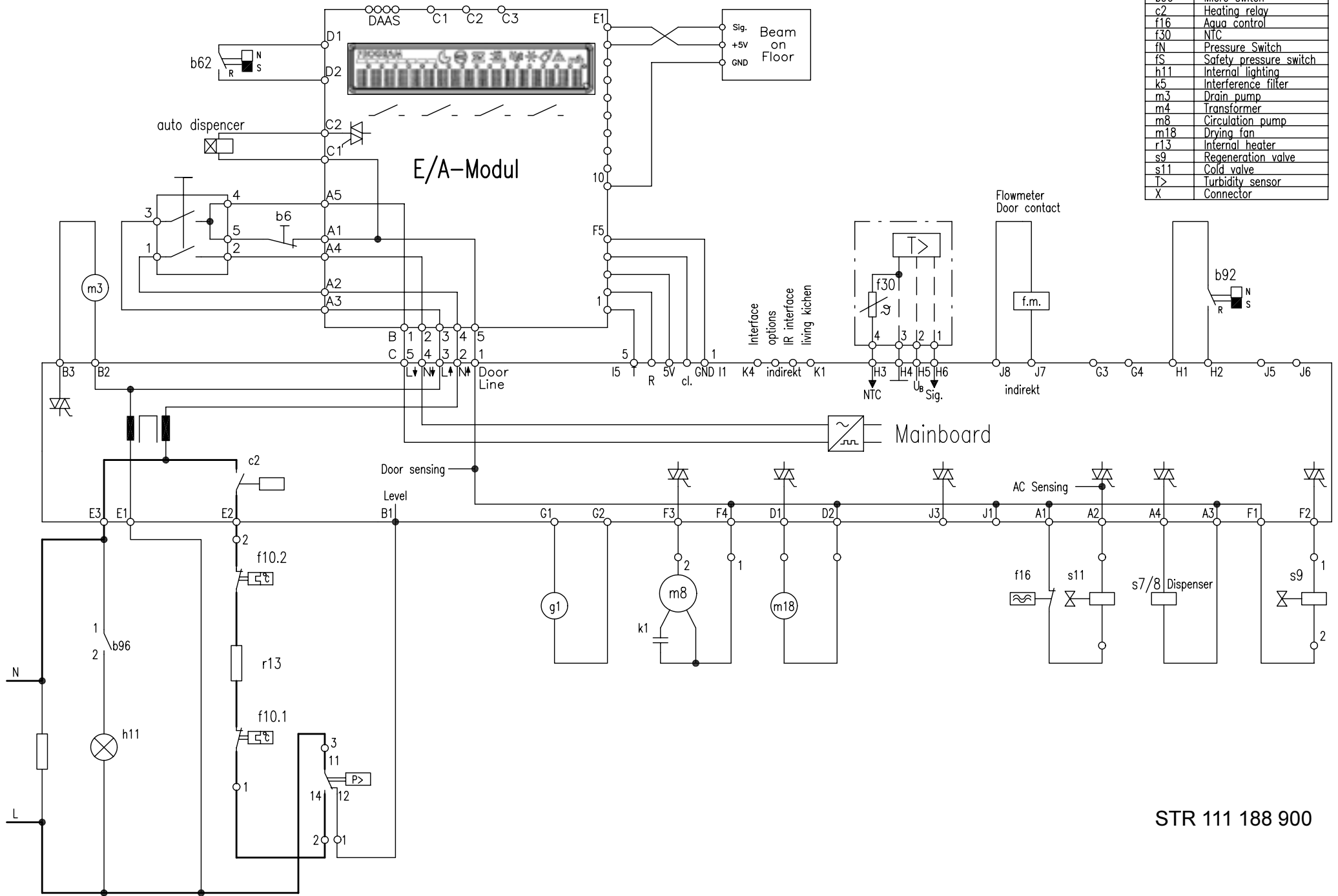

STR 111 188 900